



LOGO!Soft Comfort Online Help

Operating Instructions

<u>LOGO!Soft Comfort V8.0</u>	1
<u>User interface</u>	2
<u>Tutorial</u>	3
<u>Sample applications</u>	4
<u>Reference material</u>	5
<u>Tips and tricks</u>	6

Legal information

Warning notice system

This manual contains notices you have to observe in order to ensure your personal safety, as well as to prevent damage to property. The notices referring to your personal safety are highlighted in the manual by a safety alert symbol, notices referring only to property damage have no safety alert symbol. These notices shown below are graded according to the degree of danger.

⚠ DANGER
indicates that death or severe personal injury will result if proper precautions are not taken.
⚠ WARNING
indicates that death or severe personal injury may result if proper precautions are not taken.
⚠ CAUTION
indicates that minor personal injury can result if proper precautions are not taken.
NOTICE
indicates that property damage can result if proper precautions are not taken.

If more than one degree of danger is present, the warning notice representing the highest degree of danger will be used. A notice warning of injury to persons with a safety alert symbol may also include a warning relating to property damage.

Qualified Personnel

The product/system described in this documentation may be operated only by **personnel qualified** for the specific task in accordance with the relevant documentation, in particular its warning notices and safety instructions. Qualified personnel are those who, based on their training and experience, are capable of identifying risks and avoiding potential hazards when working with these products/systems.

Proper use of Siemens products

Note the following:

⚠ WARNING
Siemens products may only be used for the applications described in the catalog and in the relevant technical documentation. If products and components from other manufacturers are used, these must be recommended or approved by Siemens. Proper transport, storage, installation, assembly, commissioning, operation and maintenance are required to ensure that the products operate safely and without any problems. The permissible ambient conditions must be complied with. The information in the relevant documentation must be observed.

Trademarks

All names identified by ® are registered trademarks of Siemens AG. The remaining trademarks in this publication may be trademarks whose use by third parties for their own purposes could violate the rights of the owner.

Disclaimer of Liability

We have reviewed the contents of this publication to ensure consistency with the hardware and software described. Since variance cannot be precluded entirely, we cannot guarantee full consistency. However, the information in this publication is reviewed regularly and any necessary corrections are included in subsequent editions.

Table of contents

1	LOGO!Soft Comfort V8.0	11
1.1	Security information	11
1.2	Welcome to LOGO!Soft Comfort V8.0!.....	12
1.3	DVD contents	13
1.4	What's new in LOGO!Soft Comfort?	14
1.4.1	What's new in LOGO!Soft Comfort V8.0?.....	14
1.4.2	What was new in LOGO!Soft Comfort V7.0?.....	15
1.4.3	What was new in LOGO!Soft Comfort V6.1 compared with V5.x?	18
1.5	Ladder Diagram (LAD), Function Block Diagram (FBD) and User-Defined Function (UDF)	20
1.6	LOGO! and LOGO!Soft Comfort on the Internet.....	21
1.7	Compatibility.....	21
1.8	LOGO! with AS-Interface (0BA0-0BA2).....	23
1.8.1	AS-Interface	23
1.8.2	AS-Interface inputs	25
1.8.3	AS-Interface outputs	25
2	User interface	27
2.1	User interface - Overview	27
2.2	Description of the Info Window	30
2.3	Description of the status bar	31
2.4	Function keys and shortcuts	31
2.5	Diagram mode.....	32
2.5.1	Diagram tree	33
2.5.2	Instruction tree	33
2.5.3	Diagram editor.....	33
2.6	Network project	33
2.6.1	Network project tree.....	34
2.6.2	Network view.....	34
2.7	Toolbars	34
2.7.1	Standard toolbar overview	34
2.7.2	Simulation toolbar and status window	35
2.7.3	Programming toolbar	37
2.7.3.1	Selection tool.....	38
2.7.3.2	Connector tool.....	39
2.7.3.3	Cut/Join	39
2.7.3.4	Text tool	39
2.7.3.5	Page Layout.....	39
2.7.3.6	Conversion tool	40
2.7.3.7	Online test.....	41

2.7.3.8	Showing/hiding reference line (OBA8 only)	43
2.7.3.9	Expanding all parameter boxes (OBA8 only).....	43
2.7.3.10	Collapsing all parameter boxes (OBA8 only).....	43
2.7.4	Networking toolbar (OBA8 only)	44
2.7.4.1	Going online (OBA8 only)	44
2.7.4.2	Going offline (OBA8 only)	45
2.8	Menu bar	46
2.8.1	File menu.....	46
2.8.1.1	File -> New	47
2.8.1.2	File -> Open	47
2.8.1.3	File -> Close	48
2.8.1.4	File -> Close All	49
2.8.1.5	File -> Save	49
2.8.1.6	File -> Save As.....	50
2.8.1.7	File -> Page Setup	51
2.8.1.8	File -> Print preview	51
2.8.1.9	File -> Print.....	51
2.8.1.10	File -> Message Text Settings	52
2.8.1.11	File -> Properties.....	53
2.8.1.12	File -> Properties - General.....	54
2.8.1.13	File -> Properties - Hardware type	55
2.8.1.14	File -> Properties - I/O settings	55
2.8.1.15	File -> Properties - Program password	56
2.8.1.16	File -> Properties - Power on	57
2.8.1.17	File -> Properties - Additional Info.....	57
2.8.1.18	File -> Properties - Statistics	57
2.8.1.19	File -> Properties - comment.....	58
2.8.1.20	File -> Exit	58
2.8.2	Edit menu	58
2.8.2.1	Edit -> Undo	59
2.8.2.2	Edit -> Redo	59
2.8.2.3	Edit -> Delete	59
2.8.2.4	Edit -> Cut	59
2.8.2.5	Edit -> Copy	60
2.8.2.6	Edit -> Paste.....	60
2.8.2.7	Edit -> Align.....	60
2.8.2.8	Edit -> Align -> Align Vertically.....	60
2.8.2.9	Edit -> Align -> Align Horizontally	60
2.8.2.10	Edit -> Align -> Horizontally Distribute Space	61
2.8.2.11	Edit -> Align -> Vertically Distribute Space	61
2.8.2.12	Edit -> Align -> Align Automatically.....	61
2.8.2.13	Edit -> Select all	62
2.8.2.14	Edit -> Go to block.....	63
2.8.2.15	Edit -> Bring to front	63
2.8.2.16	Edit -> Send to back.....	63
2.8.2.17	Edit -> Input/output Names	63
2.8.2.18	Edit -> Block properties.....	64
2.8.2.19	Edit -> Block properties (all blocks).....	64
2.8.2.20	Edit -> Edit UDF properties	65
2.8.3	Format menu.....	65
2.8.3.1	Format -> Font	65
2.8.3.2	Format -> Wrap Text.....	65

2.8.3.3	Format -> Format grid	66
2.8.3.4	Format -> Snap to grid	66
2.8.4	View menu	66
2.8.4.1	View -> Diagram mode	67
2.8.4.2	View -> Network Project.....	67
2.8.4.3	View -> Toolbar	67
2.8.4.4	View -> Tree.....	68
2.8.4.5	View -> Select Lines	68
2.8.4.6	View -> Info Window	68
2.8.4.7	View -> Status Bar	68
2.8.4.8	View -> Tooltips	68
2.8.4.9	View -> Zoom.....	69
2.8.4.10	View -> Zoom In.....	69
2.8.4.11	View -> Zoom Out.....	69
2.8.5	Tools menu	70
2.8.5.1	Tools -> Transfer.....	70
2.8.5.2	Tools -> Transfer -> PC -> LOGO!	75
2.8.5.3	Tools -> Transfer -> LOGO! -> PC	76
2.8.5.4	Tools -> Transfer -> Start LOGO!	77
2.8.5.5	Tools -> Transfer -> Stop LOGO!	77
2.8.5.6	Tools -> Transfer -> Synchronize clock with EM	77
2.8.5.7	Tools -> Transfer -> Show FW version.....	78
2.8.5.8	Tools -> Transfer -> Clear User Program and Password	78
2.8.5.9	Tools -> Transfer -> Upload Data Log (0BA7 and 0BA8 only)	78
2.8.5.10	Tools -> Transfer -> Configure Network Address (0BA7 and 0BA8 only)	79
2.8.5.11	Tools -> Transfer -> Configure Master/Slave Mode (0BA7 and 0BA8 only)	79
2.8.5.12	Tools -> Transfer -> Set Clock.....	80
2.8.5.13	Tools -> Transfer -> Summer time/Winter time	81
2.8.5.14	Tools -> Transfer -> Set LOGO! TD Power-on Screen	82
2.8.5.15	Tools -> Transfer -> Access Control.....	83
2.8.5.16	Tools -> Transfer -> Hours Counter.....	85
2.8.5.17	Tools -> Transfer -> I/O Status (0BA7 and 0BA8 only)	86
2.8.5.18	Tools -> Transfer -> Diagnostic (0BA7 and 0BA8 only)	87
2.8.5.19	Tools -> Transfer -> Dynamic Server IP Filter (0BA8 only)	88
2.8.5.20	Tools -> Determine LOGO!.....	90
2.8.5.21	Tools -> Select Hardware	90
2.8.5.22	Tools -> Compare	90
2.8.5.23	Tools -> Simulation	95
2.8.5.24	Tools -> Simulation Parameters	95
2.8.5.25	Tools -> Connect Modem	97
2.8.5.26	Tools -> Connect Modem - Select Modem	98
2.8.5.27	Tools -> Connect Modem - Select Remote Configuration	98
2.8.5.28	Tools -> Connect Modem - Configure Remote Modem Command	98
2.8.5.29	Tools -> Connect Modem - Configure Remote Modem.....	98
2.8.5.30	Tools -> Connect Modem - Select Local Configuration	99
2.8.5.31	Tools -> Connect Modem - Configure Local Modem Command	99
2.8.5.32	Tools -> Connect Modem - Configure Telephone number	99
2.8.5.33	Tools -> Disconnect Modem	99
2.8.5.34	Tools -> Ethernet Connections (0BA7 and 0BA8 only)	100
2.8.5.35	Tools -> Parameter VM Mapping (0BA7 and 0BA8 only)	105
2.8.5.36	Tools -> Options.....	119
2.8.5.37	Tools -> Options: General.....	119

2.8.5.38	Tools -> Options: Preference	120
2.8.5.39	Tools -> Options: Print	120
2.8.5.40	Tools -> Options: Cut Connections	121
2.8.5.41	Tools -> Options: Simulation	121
2.8.5.42	Tools -> Options: Colors	122
2.8.5.43	Tools -> Options: UDF (0BA7 and 0BA8 only)	122
2.8.5.44	Tools -> Options: CSV Separator	122
2.8.6	Window menu	122
2.8.6.1	Window -> Undo Split	122
2.8.6.2	Window -> Split into two windows	123
2.8.6.3	Window -> Split into three windows	123
2.8.6.4	Window -> Selection list	123
2.8.7	Help menu	124
2.8.7.1	Help -> Contents	124
2.8.7.2	Help -> Context-sensitive help	125
2.8.7.3	Help -> Update Center	125
2.8.7.4	Help -> About	126
3	Tutorial.....	127
3.1	Prerequisites for working with the tutorial	127
3.2	Getting started with program creation	127
3.2.1	Creating a circuit program	127
3.2.1.1	Creating a new circuit program	128
3.2.1.2	Selecting blocks	128
3.2.1.3	Placing blocks	128
3.2.1.4	Editing blocks	129
3.2.1.5	Connecting blocks	130
3.2.1.6	Availability of blocks	132
3.2.1.7	Parameter box overview	133
3.2.1.8	Editing a parameter box	134
3.2.2	Editing the layout	135
3.2.2.1	Selecting objects	136
3.2.2.2	Editing selected objects	136
3.2.2.3	Replacing blocks	137
3.2.2.4	Cutting connections	137
3.2.3	Documentation and saving	139
3.2.3.1	Documentation of the circuit program	139
3.2.3.2	Opening and saving a circuit program	140
3.3	Simulation of a circuit program	141
3.3.1	Starting the simulation	141
3.3.2	Layout of inputs	141
3.3.3	Layout of the outputs	142
3.3.4	Set output	142
3.3.5	Power failure	143
3.3.6	Layout of message texts	143
3.3.7	Parameter assignment in simulation mode	146
3.3.8	Alternative operation	147
3.3.9	Controlling the simulation time	147
3.3.10	Simulating network communication (0BA7 and 0BA8 only)	147
3.3.11	Data table (0BA7 and 0BA8 only)	148
3.4	Getting started with project creation	149

3.4.1	Creating a Network project	149
3.4.1.1	Creating a new circuit project.....	149
3.4.1.2	Creating a circuit project	150
3.4.1.3	Adding a new device.....	150
3.4.1.4	Devices	150
3.4.1.5	Opening and saving a circuit project.....	153
3.4.1.6	Two-side programming	153
3.4.2	Device setting configuration.....	155
3.4.2.1	Configuring PC settings	155
3.4.2.2	Configuring LOGO! offline settings	155
3.4.2.3	Configuring LOGO! online settings	155
3.4.2.4	Configuring settings for other standard devices	156
3.4.2.5	Detecting device online status	156
3.4.2.6	Configuring settings for unknown devices	156
3.4.3	Ethernet connection configuration	157
3.4.3.1	Configuring Ethernet connection, LOGO! to local LOGO!	157
3.4.3.2	Configuring Ethernet connection, LOGO! to remote devices	161
3.4.3.3	Configuring Ethernet connection, LOGO! to LOGO! slave	163
3.4.3.4	Configuring Ethernet connection, LOGO! to S7 devices	164
3.4.3.5	Configuring Ethernet connection, LOGO! to HMI devices	165
3.4.3.6	Configuring Ethernet connection, LOGO! to non-project devices.....	166
3.5	Practical example.....	168
3.5.1	Practical example: Introduction.....	168
3.5.2	The task	168
3.5.3	Layout of the solution.....	170
3.5.4	Solution with LOGO!	171
3.5.5	Input of project data	172
3.5.6	Placing blocks	173
3.5.7	Connecting blocks.....	174
3.5.8	Cleaning up the programming interface.....	175
3.5.9	Optimizing the view.....	177
3.5.10	Testing the circuit program	178
3.5.11	Circuit program documentation.....	179
3.5.12	Transferring the circuit program.....	179
3.5.13	Performing an online test of the circuit program	180
4	Sample applications.....	181
4.1	Air-conditioning system.....	181
4.2	Factory door.....	183
4.3	Heating control.....	184
4.4	Fill station.....	187
5	Reference material	191
5.1	Constants and connectors	191
5.1.1	FBD and UDF.....	193
5.1.1.1	Inputs	193
5.1.1.2	Cursor keys.....	193
5.1.1.3	LOGO! TD/LOGO! TDE function keys	193
5.1.1.4	Outputs.....	194
5.1.1.5	Permanent logical levels	194

5.1.1.6	Shift register bits	194
5.1.1.7	Open connectors	195
5.1.1.8	Flags.....	195
5.1.1.9	Analog inputs	196
5.1.1.10	Analog outputs	197
5.1.1.11	Network inputs (0BA7 and 0BA8 only).....	198
5.1.1.12	Network analog inputs (0BA7 and 0BA8 only).....	200
5.1.1.13	Network outputs (0BA7 and 0BA8 only)	202
5.1.1.14	Network analog outputs (0BA7 and 0BA8 only)	203
5.1.2	LAD	205
5.1.2.1	Make contact.....	205
5.1.2.2	Break contact	205
5.1.2.3	Analog contact	205
5.1.2.4	Relay coil.....	206
5.1.2.5	Inverted output	206
5.1.2.6	Analog output.....	206
5.1.2.7	Network inputs (0BA7 and 0BA8 only).....	206
5.1.2.8	Network analog inputs (0BA7 and 0BA8 only).....	206
5.1.2.9	Network outputs (0BA7 and 0BA8 only)	206
5.1.2.10	Network analog outputs (0BA7 and 0BA8 only)	207
5.2	Basic functions (FBD and UDF Editors).....	207
5.2.1	AND.....	208
5.2.2	AND with edge evaluation.....	208
5.2.3	NAND	209
5.2.4	NAND with edge evaluation	209
5.2.5	OR	210
5.2.6	NOR	211
5.2.7	XOR.....	211
5.2.8	NOT.....	212
5.3	Special functions	212
5.3.1	Timers	217
5.3.1.1	On-delay.....	217
5.3.1.2	Off-delay.....	218
5.3.1.3	On-/Off-delay.....	220
5.3.1.4	Retentive on-delay	222
5.3.1.5	Wiping relay (pulse output)	224
5.3.1.6	Edge triggered wiping relay.....	225
5.3.1.7	Symmetrical pulse generator	227
5.3.1.8	Asynchronous pulse generator	228
5.3.1.9	Random generator	230
5.3.1.10	Stairway lighting switch.....	232
5.3.1.11	Multiple function switch	234
5.3.1.12	Weekly timer	236
5.3.1.13	Yearly timer	239
5.3.1.14	Astronomical clock (0BA7 and 0BA8 only)	243
5.3.1.15	Stopwatch (0BA7 and 0BA8 only).....	245
5.3.2	Counters.....	247
5.3.2.1	Up/Down counter	247
5.3.2.2	Hours counter.....	249
5.3.2.3	Threshold trigger	253
5.3.3	Analog	255

5.3.3.1	Analog threshold trigger	255
5.3.3.2	Analog differential trigger	260
5.3.3.3	Analog comparator	262
5.3.3.4	Analog watchdog	265
5.3.3.5	Analog amplifier	268
5.3.3.6	Analog multiplexer	269
5.3.3.7	Pulse Width Modulator (PWM).....	273
5.3.3.8	Mathematic instruction.....	276
5.3.3.9	Analog filter (0BA7 and 0BA8 only)	279
5.3.3.10	Max/Min (0BA7 and 0BA8 only).....	280
5.3.3.11	Average value (0BA7 and 0BA8 only)	285
5.3.4	Analog value processing	286
5.3.4.1	Basics.....	286
5.3.4.2	Possible settings with LOGO!Soft Comfort.....	289
5.3.4.3	Possible settings with LOGO!	290
5.3.4.4	Example	291
5.3.4.5	0BA0 to 0BA4.....	292
5.3.5	Control and regulate	293
5.3.5.1	Control and regulate basics	293
5.3.5.2	Controller basics	296
5.3.5.3	Description of the individual parameters.....	299
5.3.5.4	PI controller.....	300
5.3.5.5	Analog ramp.....	304
5.3.6	Miscellaneous	307
5.3.6.1	Latching relay.....	307
5.3.6.2	Pulse relay	308
5.3.6.3	Message text (LOGO! 0BA8)	310
5.3.6.4	Message text (LOGO! 0BA6 and LOGO! 0BA7).....	315
5.3.6.5	Message text (LOGO! 0BA4 and LOGO! 0BA5).....	327
5.3.6.6	Message text (LOGO! 0BA2 and LOGO! 0BA3).....	330
5.3.6.7	Softkey	331
5.3.6.8	Shift register (0BA7 to 0BA8).....	333
5.3.6.9	Shift register (0BA4 to 0BA6).....	335
5.3.6.10	Mathematic instruction error detection.....	337
5.3.6.11	Additional functions of the LAD Editor	338
5.4	Data log profile (0BA7 & 0BA8 only).....	339
5.4.1	What is a data log?	339
5.4.2	Configuring the data log.....	339
5.4.3	Transferring the data log.....	340
5.4.4	Opening an uploaded data log.....	341
5.5	UDF (0BA7 & 0BA8 only).....	341
5.5.1	What is a UDF?.....	341
5.5.2	Creating a UDF	341
5.5.3	Editing the UDF.....	344
5.5.4	Saving the UDF.....	352
5.5.5	Using the UDF in an FBD circuit program or another UDF	352
5.5.6	Synchronizing UDF versions.....	355
5.6	Circuit programs.....	356
5.6.1	LOGO! hardware.....	357
5.6.2	Memory	360
5.6.2.1	Memory requirements	360

5.6.2.2	Memory space.....	365
5.6.3	Blocks and block numbers	366
5.6.3.1	Blocks.....	366
5.6.3.2	Block numbers	367
5.7	Network projects	368
6	Tips and tricks.....	369
6.1	Tips and tricks	369
6.2	How to maintain an overview during simulation.....	369
6.3	A quick and easy way of selecting blocks and placing these into your circuit program.....	369
6.4	A quick and easy way of connecting blocks in large circuit programs	370
6.5	How to display a corresponding tooltip for a function key.....	371
6.6	How to identify your circuit program version	371
6.7	How to access functions via the shortcut menu.....	371
6.8	A quick and easy way of zooming your circuit program window.....	371
6.9	A quick way of changing block parameters.....	371
6.10	A quick way of closing circuit diagrams without saving the data	372
6.11	How to establish the cycle time.....	372
	Index.....	373

LOGO!Soft Comfort V8.0

1.1 Security information

Siemens provides products and solutions with industrial security functions that support the secure operation of plants, solutions, machines, equipment and/or networks. They are important components in a holistic industrial security concept. With this in mind, Siemens' products and solutions undergo continuous development. Siemens recommends strongly that you regularly check for product updates.

For the secure operation of Siemens products and solutions, it is necessary to take suitable preventive action (e.g. cell protection concept) and integrate each component into a holistic, state-of-the-art industrial security concept. Third-party products that may be in use should also be considered. You can find more information about industrial security on the Internet (<http://www.siemens.com/industrialsecurity>).

To stay informed about product updates as they occur, sign up for a product-specific newsletter. You can find more information on the Internet (<http://support.automation.siemens.com>).

Note

To protect LOGO!Soft Comfort from any undesired manipulation when your PC suffers malicious attacks from the Internet, Siemens strongly recommends you to install a whitelist tool such as McAfee Application Control 6.1 on the PC.

1.2 Welcome to LOGO!Soft Comfort V8.0!



What's new in LOGO!Soft Comfort (Page 14)



Elements of the software interface (Page 27)



Tutorial (Page 127)

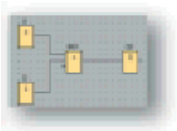

Sample applications (Page 181)



Reference material:

- Constants and terminal blocks (Page 191)
- Basic functions (FBD and UDF Editors) (Page 207)
- SFBs (Page 212)
- Circuit programs (Page 356)



Tips and tricks (Page 369)

Help → Contents (Page 124)

Help → Context-sensitive help (Page 125)

1.3 DVD contents

The DVD-ROM

The DVD-ROM includes your installation software for LOGO!Soft Comfort and contains additional useful information.

Start.html

This file guides you through the contents of the DVD-ROM. It helps you to perform these tasks:

- Install LOGO!Soft Comfort
- Start LOGO!Soft Comfort

The file also provides you with access to the following items:

- CAD drawings
- Manuals
- Drivers

Folders on the DVD-ROM:

The list below describes some of the folder contents of the DVD-ROM:

- The ..\CAD folder contains CAD drawings of the LOGO! devices.
- The ..\Manual folder contains the current *LOGO! Manual* as a PDF file that you can read with AcrobatReader.
- The ..\Onlinehelp folder contains the current LOGO!Soft Comfort online help as a PDF file that you can read with AcrobatReader.
- The ..\Readme folder contains an HTML readme file that includes information that you need to know prior to installation.
- The ..\Sample folder contains a few sample applications, which give you example solutions for a few of the many fields of applications of the versatile LOGO!.
- The DVD-ROM also contains the installation versions of LOGO!Soft Comfort for different operating systems:
 - The ..\Linux\Application_32 folder contains the installation files for Linux 32-bit operating systems.
 - The ..\Linux\Application_64 folder contains the installation files for Linux 64-bit operating systems.
 - The ..\Windows\Application_32 folder contains the installation files for Windows 32-bit operating systems.
 - The ..\Windows\Application_64 folder contains the installation files for Windows 64-bit operating systems.
 - The ..\Mac\Application folder contains the installation files for Apple Macintosh operating systems.

Simply copy the corresponding ..\Application folder to your hard disk drive and start LOGO!Soft Comfort by calling ..\Application\LOGOComfort.

The ..\Windows\Application_32 folder is used for Windows 32-bit operating system and the ..\Windows\Application_64 folder is used for Windows 64-bit operating system.

1.4 What's new in LOGO!Soft Comfort?

1.4.1 What's new in LOGO!Soft Comfort V8.0?

The features described below are only used for LOGO!Soft Comfort V8.0.

New features

LOGO!Soft Comfort V8.0 provides a brand new user interface with the following features:

- Consistent application menu display
- New network project-based working approach
- Split display of diagram mode (Page 32) and network project mode (Page 33)
- Split display of standard toolbar (Page 34) in the general software interface, showing the programming toolbar (Page 37) under diagram mode, and showing the networking toolbar (Page 44) under project mode
- Split window (Page 122) display with focus control switching and drag-and-drop connections capabilities
- Ability to work on a network project (Page 368) with tasks of saving, loading, creating and closing the network project
- New access control (Page 83) settings to authorize online access with different access occasions
- Ability to create connections through configuring NI and NQ function blocks (Page 161)
- Ability to configure screen display for message (Page 52), power-on screen (Page 82) and flags (Page 195) into:
 - 4 lines for LOGO! devices prior to 0BA8
 - 6 lines for LOGO! devices of 0BA8
- New graphical reference for the function block of parameter box (Page 133) in FBD diagrams
- Enhanced system security through setting user passwords and access level accounts through access control (Page 83) settings

Other software updates

LOGO!Soft Comfort V8.0 also includes updates to improve the software performance and ease of use, for example:

- Support for up to 20 digital outputs and 8 analog outputs
- Support for a longer block name of up to 12 characters in ASCII format
- New layout recovery abilities after you download the circuit program (Page 75) and load it again

- New parameters of sunrise offset and sunset offset in the astronomical clock (Page 243) function block
- New access control list of up to 8 list items through dynamic IP filter (Page 88)
- New diagnostic panel (Page 87) with different kinds of error information:
 - 4 types of error information for 0BA7
 - 5 types of error information for 0BA8
- Programming improvement: (Page 127)
 - Ability to create connections without choosing the connector tool
 - Ability to add a single block with only a single click the block
 - Ability to add multiple blocks repeatedly using the stamp function by double-clicking the block
- Support for saving a diagram to SD card as a Bin file which can be executed by LOGO! Basic directly
- Zooming effects update for zoom in (Page 69) and zoom out (Page 69)
- Support for displaying 3 cams in the same panel of the Weekly timer (Page 236) function block
- Support for using comma or semicolon as CSV separator (Page 122)
- New printing defaults to only print the function blocks added in the circuit diagram
- Ability to check the open blocks in a diagram and display them in the info window (Page 30) (with the short-cut of F2)
- Support for adding and configuring a client/server connection (Page 100)

New project-based working approach

LOGO!Soft Comfort V8.0 provides a brand new working method with which you can easily build up your network project in a conceptual network view. You are even able to configure network connections by simply dragging and dropping the I/O points of the devices or the network compliant function blocks from one to another.

1.4.2 What was new in LOGO!Soft Comfort V7.0?

The features described below were new for LOGO!Soft Comfort V7.0.

New connectors

LOGO!Soft Comfort V7.0 provides new network connectors:

- Network inputs (Page 198)
- Network analog inputs (Page 200)
- Network outputs (Page 202)
- Network analog outputs (Page 203)

New SFBs

The following SFBs are new:

- Astronomical clock (Page 243)
- Analog filter (Page 279)
- Max/Min (Page 280)
- Average value (Page 285)
- Stopwatch (Page 245)

Updated SFBs

The following SFBs support new features:

- Message text (Page 315)
- Shift register (Page 333)

The analog math SFB is renamed "Mathematic instruction".

The analog math error detection SFB is renamed "Mathematic instruction error detection".

Additionally, LOGO!Soft Comfort V7.0 supports new reference parameters for some blocks, such as timer blocks and the analog filter block.

New LOGO! Base Modules

Two new LOGO! Base Modules are commercially available:

- LOGO! 12/24RCE
- LOGO! 230RCE

The main change of the functionalities of these two new base modules is that the new ones have the Ethernet capability. For detailed information about these two base modules, refer to your product information and the *LOGO! Manual*.

New features

LOGO!Soft Comfort V7.0 together with the LOGO! 0BA7 hardware series provides the following new features:

- S7 communication: Base Modules can communicate with each other on an Ethernet network as well as with SIMATIC controllers or SIMATIC HMI devices with Ethernet capability.
- UDF (User-defined function) Editor
- SD card support
- Data log
- Online test of the network transfer data and message text
- Diagnostics for networking errors and SD card Read/Write errors
- Simulation of the network

- Ability to identify LOGO! 0BA7 firmware version
- I/O name import/export
- I/O status
- LOGO! Base Module slave mode configuration
- Ability to display reference information in circuit program
- Block replacement
- Remote change of parameters

Changed functionality

LOGO!Soft Comfort V7.0 provides changes in the following areas:

- Maximum number of blocks increased from 200 to 400
- Amount of program memory (RAM) increased from 3800 to 8400 bytes
- Number of analog flags increased from 6 to 16
- Number of shift registers increased from 1 to 4, and shift register bits from 8 bits to 32 bits
- Number of open connectors increased from 16 to 64
- RTC buffering time extended from 80 hours to 20 days
- Zoom factors configurable in Print Preview
- Two additional object alignment options available
- Two additional block sorting methods available– sort by block type or name
- Text wrapping available for text boxes on a circuit program
- New color setting for UDF block frame
- Additional warning message prompt for hours counter value reset when program downloading
- One additional option on the Start Screen display
- Ability to link comments to function blocks and cut connectors
- LAN time synchronization added to the Set clock function

Note

LOGO! 0BA7 no longer supports an RTC (Real Time Clock) battery card.

1.4.3 What was new in LOGO!Soft Comfort V6.1 compared with V5.x?

New SFBs

LOGO!Soft Comfort V6.1 introduced the following SFBs:

- Pulse Width Modulator (PWM) (Page 273)
- Mathematic instruction (Page 276)
- Mathematic instruction error detection (Page 337)

Updated SFBs

The following SFBs support new features:

- Message text (Page 315)
- Operating hours counter (Page 249)
- Weekly timer (Page 236)
- Yearly timer (Page 239)
- Analog watchdog (Page 265)
- Up/Down counter (Page 247)

Additionally, LOGO!Soft Comfort supports new reference parameters for many blocks (Page 212).

New LOGO! TD module

LOGO! supports a new text display module. This LOGO! TD module extends the display and user interface capabilities of a LOGO! Base Module. LOGO!Soft Comfort provides configuration of the following LOGO! TD features:

- Power-on screen
- Function keys
- Message texts
- Backlight function

For further information about the LOGO! TD module, refer to your product information and the *LOGO! Manual*.

New LOGO! Base Modules

Two new LOGO! Base Modules (each with a built-in real-time clock) are commercially available:

- LOGO! 24C
- LOGO! 24Co

For detailed information about these two Base Modules, refer to your product information and the *LOGO! Manual*.

New LOGO! expansion module

One new LOGO! expansion module is commercially available:

- LOGO! AM2 RTD

This expansion module is equipped with two analog inputs for connection to PT100 and/or PT1000 sensors with the default temperature coefficient of $\alpha = 0.003850$ for both sensor types. It can automatically recognize the sensor type, thus it is unnecessary for you to make any configuration or setting to achieve this.

For detailed information about this expansion module, refer to your product information and the *LOGO! Manual*.

New features

LOGO!Soft Comfort together with the LOGO! 0BA6 hardware series provides the following new features:

- Method to delete user program and password from LOGO! 0BA6
- Additional languages, resolution, and backlight function for the LOGO! 0BA6 onboard display
- Ability to perform online tests of LAD circuit programs
- Display of PI controller analog output value in a trend view during simulation or online test
- Modem communication between a PC and LOGO! 0BA6
- USB cable communication between a PC and LOGO! Base Module
- New memory card, battery card and combined memory/battery card for LOGO! 0BA6 devices.

Changed functionality

LOGO!Soft Comfort provides changes in the following areas:

- Number of user program blocks increased to 200 blocks
- Additional retentive memory for a total of 250 bytes
- Configuration support for all I/O changes to LOGO! Base Modules and expansion modules

Prior versions

For information about features that were new in versions prior to LOGO!Soft Comfort V6.1, refer to the documentation for earlier versions. Current and previous documentation can be found at the LOGO! Internet Web site (Page 21).

1.5 Ladder Diagram (LAD), Function Block Diagram (FBD) and User-Defined Function (UDF)

LOGO!Soft Comfort provides you with three options of creating circuit programs:

- Ladder diagram (LAD)
- Function block diagram (FBD)
- User-defined function (UDF)

Who will use the ladder diagram (LAD)?

The LAD program editor is suitable for users who are used to working with circuit programs.

Who will use the function block diagram (FBD)?

The FBD program editor is suitable for users who are familiar with the logic boxes of Boolean algebra.

What is the User-Defined Function (UDF)?

UDF is a circuit logic diagram of a group of function blocks, and can be used as a function block in an FBD.

In the following contents, a UDF is called a UDF type, and the copy of a UDF is called a UDF instance. For details, see Using the UDF in an FBD circuit program or another UDF (Page 352).

Differences between LAD, FBD and UDF in the online help

The online help primarily describes the FBD Editor, because its functionality is closely related to that of the LAD Editor. The UDF is described separately. Where LAD, FBD and UDF differ, the online help describes the differences. The following symbol in the online help indicates the difference in LAD, FBD and UDF functionality:



Converting circuit programs

For information on converting circuit programs, refer to the topics for converting LAD to FBD and from FBD to LAD.

Switching between LAD, FBD, and UDF

You can switch the editor from the Options selection of the Tools menu (Page 47).

1.6 LOGO! and LOGO!Soft Comfort on the Internet

From the Support selection at <http://www.siemens.com/logo/> you will find abundant information about LOGO! and LOGO!Soft Comfort:

- Updates and upgrades (Page 125) for LOGO!Soft Comfort
- Additional language packages, if the LOGO!Soft Comfort DVD-ROM does not contain your language
- Numerous sample programs and applications
- FAQs (frequently asked questions)
- Downloads of current manuals and training documentation
- News and other information

1.7 Compatibility

Compatibility with previous LOGO! Hardware series

LOGO!Soft Comfort V8.0 is optimized for LOGO! devices of the 0BA8 (indicated by the order number).

You can also use the current LOGO!Soft Comfort version to create circuit programs for the previous LOGO! hardware series. You cannot, however, download programs that use the new SFBs or new SFB parameters to LOGO! devices prior to the 0BA8 series. LOGO!Soft Comfort provides a list of hardware that is compatible with your circuit program from the Tools → Select Hardware (Page 90) menu command. You can download your circuit program to any device in the list.

You can continue to use the input connectors of some of the LOGO! 0BA8 devices as they were prior to 0BA8, that is, as inputs. However with the 0BA7 and 0BA8 series, these inputs can also be used for analog inputs or high-speed counters. Existing LOGO!Soft Comfort programs that use these connectors as inputs will function in the same way as they did. New programs can make use of the new analog inputs and high-speed counters. Refer to your product information and the *LOGO! Manual* for detailed information about these modules: LOGO! 12/24RCE, LOGO! 230RCE, LOGO! 230RC, LOGO! 230RCo, LOGO! 12/24RC, LOGO! 12/24RCo, LOGO! 24, LOGO! 24o, LOGO! 24C and LOGO! 24Co.

Any differences concerning the operation of LOGO!Soft Comfort that are based on differences between the previous series and LOGO! 0BA8 are described separately. If programming differences exist based on the LOGO! series, this online help system uses this graphic to alert you to those differences:



Compatibility with previous versions of LOGO!Soft Comfort

You can edit and expand circuit programs written with older versions of LOGO!Soft Comfort using your current LOGO!Soft Comfort version.

Compatibility with previous LOGO! memory cards

Refer to the *LOGO! Manual* for compatibility information regarding LOGO! memory cards. LOGO!Soft Comfort does not access programs stored on memory cards.

Note

LOGO! devices with AS-Interface

You can connect the modular LOGO! via a communication module to an AS-Interface (Page 23) bus.

In doing so, the AS inputs and outputs behave just like standard inputs and outputs.

Suggested operating systems

LOGO!Soft Comfort V8.0 supports the following operating systems:

- **Windows:** Windows XP, Windows 7, or Windows 8 with the following requirements:
 - PC with Pentium IV processor
 - 150 MB free hard disk space
 - 256 MB RAM
 - SVGA graphics card with minimum of 800 x 600 resolution (at least 256 colors)
 - DVD-ROM
- **Mac OSx:** Mac OSx 10.6, Mac OSx 10.7, Mac OSx 10.8, Mac OSx 10.9. Compatible with Mac OS X 10.6 Snow Leopard; Mac OS X Lion; Mac OS X MOUNTAIN LION; Mac OS X Mavericks.
- **Linux:** Tested with SUSE Linux 11.3 sp3, kernel 3.0.76. Compatible with all Linux distributions which are aligned with Java 2. You can find the necessary hardware requirements from the corresponding Linux distribution.

See also

LOGO! Hardware (Page 357)

Here you find information about the individual hardware series. This topic also includes a table from which you can see which basic and special functions are available as of which hardware series.

1.8 LOGO! with AS-Interface (0BA0-0BA2)

1.8.1 AS-Interface

Introduction

Here in this section, you discover what you must note when using a LOGO! with integrated AS-Interface.

Converting circuit programs

The LOGO!Soft Comfort converts the circuit programs with AS-Interface inputs (Page 25) or AS-Interface outputs (Page 25) which were created for previous versions of the modular LOGO! are converted:

- When you assign a circuit program to a LOGO! Basic via Tools → Select Hardware (Page 90)
- When you download a circuit program without changes to a LOGO! Basic

If you cut one or more AS-Interface inputs or outputs of an older circuit program and pasted them into the circuit program for a LOGO! Basic, the inserted I/O is also converted in the new circuit program.

Conversion rules

The inputs Ia1 to Ia4 are converted to I13 to I16.

Outputs Qa1 to Qa4 are converted to Q9 to Q12.

After conversion, the info window shows you which AS-Interface I/O was converted to that of the modular LOGO!. If the conversion is not compatible to your physical hardware structure, you must adapt the block numbers of the relevant I/O via the block properties dialog.

Additional constants and connecting terminals

Note that LOGO! versions 0BA0 to 0BA2 do not distinguish between standard inputs and AS-Interface inputs. Due to the modular structure of the devices as of version 0BA3, the block number of a digital, analog or AS-Interface block is determined by the slot position of the expansion module.

AS-Interface inputs (Page 25)

The relevant LOGO! versions are also equipped with Ia inputs used for the ASi bus (Page 25).

Modular LOGO! devices as of the series 0BA3 do not distinguish between normal inputs and AS-Interface inputs. The user determines the type of input based on the modules used and the order in which they are installed. This is why AS-Interface inputs are here displayed only as I input.

AS-Interface outputs (Page 25)

Outputs for the AS-Interface bus can be identified by the letter Qa (only available for the relevant LOGO! versions). Modular LOGO! devices as of the series 0BA3 do not distinguish between normal inputs and AS-Interface inputs. The user determines the type of the input, based on the inserted modules and the order in which they are installed. This is why AS-Interface outputs are only designated by the letter Q.

1.8.2 AS-Interface inputs



You can connect LOGO! versions of the type LB11 directly to an AS-Interface bus.

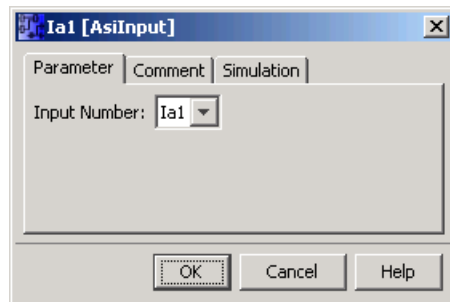

AS-Interface inputs are named Ia. The block number of an AS-Interface input is determined by the hardware structure.

LOGO!Soft Comfort converts circuit programs with AS-Interface I/O for use in the LOGO! Basic.

You can find relevant information in the section "Converting circuit programs (Page 23)".

1.8.3 AS-Interface outputs

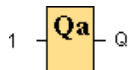

You can connect LOGO! versions of the type LB11 directly to an AS-Interface bus.

AS-Interface outputs are named Qa. The block number of an AS-Interface output is determined by the hardware structure.

The output always carries the signal of the previous program cycle. This value does not change within the current program cycle.

LOGO!Soft Comfort converts circuit programs with AS-Interface I/O for use in the LOGO! Basic.

You can find the relevant information in the section "Converting circuit programs (Page 23)".

User interface

2.1 User interface - Overview

Programming interface

LOGO!Soft Comfort program mode starts with an empty circuit diagram.

The programming interface for creating your circuit programs occupies the greater part of the screen. The icons and logical links of the circuit program are arranged on this programming interface.

To help you to maintain an overview of large circuit programs, the right side and the bottom of the programming interface contain scroll bars, which you can use for vertical and horizontal scrolling of the circuit program.

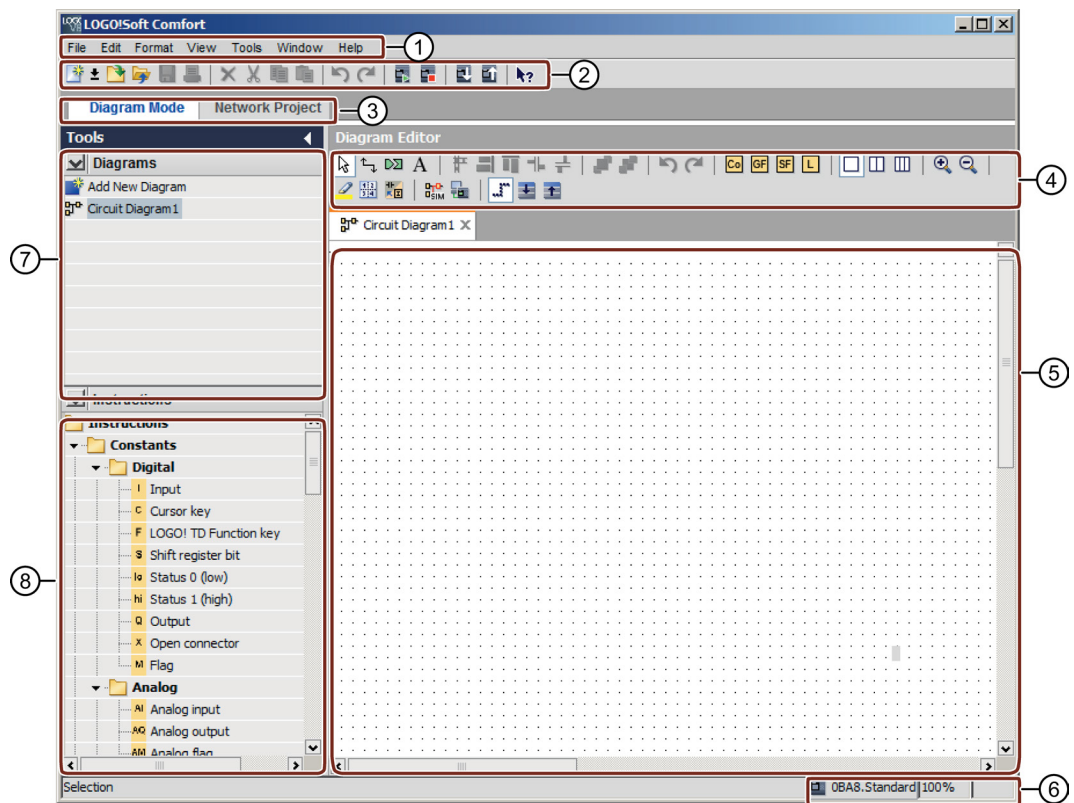

- | | |
|-----------------------|-------------------------|
| ① Menu bar | ⑤ Programming interface |
| ② Standard toolbar | ⑥ Status bar |
| ③ Mode bar | ⑦ Diagram tree |
| ④ Programming toolbar | ⑧ Instruction tree |

Project interface

LOGO!Soft Comfort project mode starts with the empty user interface of LOGO!Soft Comfort. After you choose and add a new device in the project, LOGO!Soft Comfort enables the diagram editor frame.

LOGO!Soft Comfort displays a Network view in the project interface that shows the devices and network connections. The Diagram editor displays the program blocks and logical links of the circuit program. Initially, the circuit program is empty.

To help you to maintain an overview of large circuit project and programs, the right side and the bottom of the Network view and programming interface contain scroll bars, which you can use for vertical and horizontal scrolling of the circuit program.

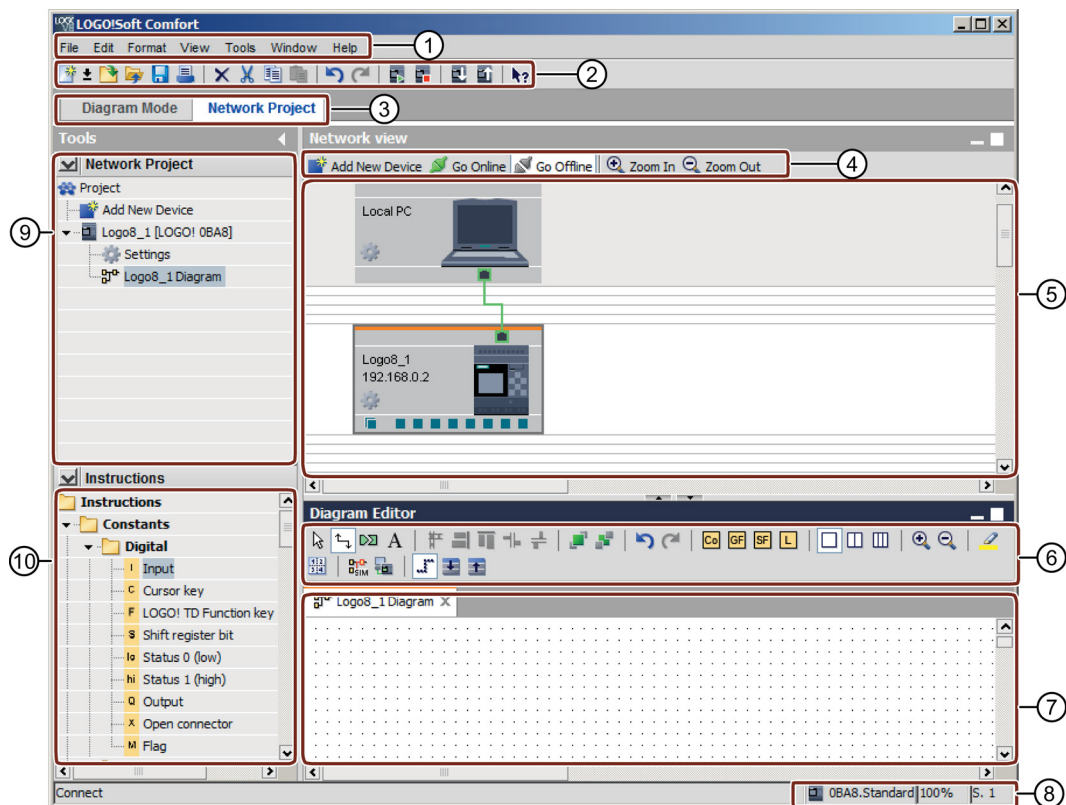

- ① Menu bar
- ② Standard toolbar
- ③ Mode bar
- ④ Networking toolbar
- ⑤ Network view
- ⑥ Programming toolbar
- ⑦ Programming interface
- ⑧ Status bar
- ⑨ Device tree
- ⑩ Instruction tree

Menu bar

The top of the LOGO!Soft Comfort window contains the menu bar. Here, you can find various commands for editing and managing your circuit programs, as well as functions for defining your default settings and for transferring of the circuit program to and from LOGO!.

Toolbars

LOGO!Soft Comfort provides the following four toolbars:

- Standard toolbar (Page 34)
- Programming toolbar (Page 37)
- Simulation toolbar (Page 35)
- Networking toolbar (Page 44)

Standard toolbar

The standard toolbar (Page 34) appears above the programming interface. Initially, LOGO!Soft Comfort shows you a reduced standard toolbar that provides only the essential functions.

The standard toolbar provides direct access to the essential functions of LOGO!Soft Comfort.

After you have opened a circuit program for editing on the programming interface, you can see the complete standard toolbar.



You can use the icons to create a new circuit program or to download, save an existing program or project, cut/copy and paste objects, undo/redo the last action, or initiate data transfer to and from LOGO! devices.

Programming toolbar

The top of the programming interface contains programming toolbar (Page 37). You can use the icons on this toolbar to change to other editing modes, or for quick and easy creation or editing of a circuit program.

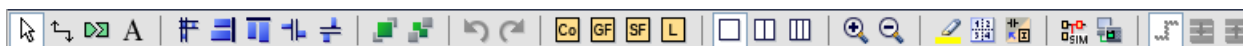

You can use the icons to connect/comment/align the blocks, redo/undo the last action, add the functional blocks, split windows, simulation/online test the diagram and expand/collapse the parameter box.



The LAD Editor no longer contains the Basic function (GF) icon, because you create logical "AND" and "OR" links by interconnecting individual blocks.

2.2 Description of the Info Window

Simulation toolbar

This toolbar (Page 35) is only relevant for the simulation of circuit programs.

Status bar

The status bar (Page 31) is located at the bottom of the program window. It shows the currently active tool, the program status, the zoom factor, the page number of the circuit program and the selected LOGO! device.

See also

Description of the Info Window (Page 30)

Tools -> Determine LOGO! (Page 90)

2.2 Description of the Info Window

Content

The Info Window shows the following information:

- Error messages generated at the start of simulation
- LOGO! devices that are determined for a program download, as determined by the Tools → Determine LOGO! (Page 90) menu command or the [F2] function key.
- The date and time of the message
- The name of the circuit program for which the message was generated

If you have opened more than one circuit program, you can determine to which program the message belongs.

At the start of simulation mode, the function analyzes the circuit program with regard to its resources and the LOGO! to be used. The Info Window displays the resources used and the errors that occurred.

The Info Window displays all information in successive order. Use the scroll bar to browse all the information pages. LOGO!Soft Comfort deletes all information from the Info Window when you close LOGO!Soft Comfort.

Operation

You can open and close the Info Window with the View → Info window (Page 68) menu command or the [F4] function key (Page 31). The Info window usually appears below the programming interface and at the right side of the block tree

You can clear messages by clicking  in the info window.

2.3 Description of the status bar

The status bar consists of four sections and contains useful information about your circuit program.

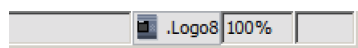

① ② ③ ④

- ① Information field: displays the currently used tool (Page 37).
- ② Displays your selected LOGO! by means of a LOGO!Soft Comfort tooltip. If you have not yet selected a LOGO!, or want to change the selection, you can double-click the LOGO! icon to display the Tools → Select Hardware (Page 90) dialog.
- ③ Shows the currently set zoom factor (Page 69).
- ④ Displays the current circuit program page.

2.4 Function keys and shortcuts

LOGO!Soft Comfort provides the following function keys and shortcuts for frequently called functions:

Function keys in LOGO!Soft Comfort:

[F1]	Calls the context sensitive Online Help (Page 125)
[F2]	Tools → Determine LOGO! (Page 90)
[F3]	Simulation start/exit (Page 95)
[F4]	View → Info Window (Page 68)
[F5]	Connector tool (Page 39)
[F6]	Constants and connectors tool (Page 191)
[F7]	Basic functions tool (Page 207)
[F8]	Special functions tool (Page 212)
[F9]	Text tool/Insert comments tool (Page 39)
[F10]	Opens the menu bar (Page 46)
[F11]	Cut/Join tool (Page 39)

Shortcuts in LOGO!Soft Comfort:

	In the File menu (Page 46):
[Ctrl+N]	File → New (Page 47) (opens the default editor specified under Tools/Options/Editor)
[Ctrl+O]	File → Open (Page 47)
[Ctrl+F4]	File → Close (Page 48)
[Ctrl+S]	File → Save (Page 49)

[Ctrl+Shift+F1]	File → Print preview (Page 51)
[Ctrl+P]	File → Print (Page 51)
[Alt+Enter]	File → Properties (Page 53)
[Alt+F4]	File → Exit (Page 58)
	In the Edit menu (Page 58):
[Ctrl+Z]	Edit → Undo (Page 59)
[Ctrl+Y]	Edit → Redo (Page 59)
[DELETE]	Edit → Delete (Page 59)
[Ctrl+X]	Edit → Cut (Page 59)
[Ctrl+C]	Edit → Copy (Page 60)
[Ctrl+V]	Edit → Paste (Page 60)
[Ctrl+A]	Edit → Select all (Page 62)
[Ctrl+G]	Edit → Go to block (Page 63)
	In the View menu (Page 66):
[Ctrl+M]	Select Connections (Page 68)
[Ctrl+mouse wheel]	View → Zoom in (Page 69) View → Zoom out (Page 69)
	In the Tools menu (Page 70):
[Ctrl+D]	Tools → Transfer: PC → LOGO! (Page 75)
[Ctrl+U]	Tools → Transfer: LOGO! → PC (Page 76)
[Ctrl+H]	Tools → Select Hardware (Page 90)
[Ctrl+-]	Tools → Compare (Page 90)



How to access functions via the shortcut menu (Page 371)



2.5 Diagram mode

In diagram mode, you can create, edit, simulate download and upload your circuit program. The programming interface for creating your circuit programs occupies the greater part of the screen. The icons and logical links of the circuit program are arranged on this programming interface. The diagrams tree and instructions tree are arranged on the left of the programming interface.

- Diagram tree (Page 33)
- Instructions tree (Page 33)
- Diagram editor (Page 33)

2.5.1 Diagram tree

You can manage your diagrams in the circuit diagram tree. This diagram tree lists all the diagrams you newly created or opened. You can switch to a diagram by double clicking its name in the diagram tree.

You can open and close this diagram tree via the icons  or  of the diagram and instructions trees.

2.5.2 Instruction tree

This instruction tree provides a hierarchical list of all elements you can use to create your circuit program.



How to select blocks and place them into your circuit program quickly
(Page 369)

2.5.3 Diagram editor

The diagram editor is the working space for the circuit program. It displays all the opened and newly created circuit programs. You can switch to a certain circuit program by clicking its title on top of the editor. You can view two or three circuit programs at the same time by splitting the working space to two or three windows.

Note

Only the LOGO! 0BA8 circuit programs in the project mode supports two-side programming.

When you edit the circuit diagrams in split windows in project mode, you can connect the blocks between different LOGO! 0BA8 circuit programs. For more information on two sides programming, see Two-side programming (Page 153).



2.6 Network project

In the project mode, you can configure your network project and manage the circuit program. The network view for configuring the network occupies the greater part of the screen. When you add a new device in the network, LOGO!Soft Comfort creates a new circuit diagram automatically. The Network project tree and instruction tree appear to the left of the programming interface.

- Network project tree (Page 34)
- Network view (Page 34)
- Diagram editor (Page 33)
- Instruction tree (Page 33)

2.6.1 Network project tree

You can manage your devices in the network project tree. This tree lists all the devices in the network project. You can add new devices and configure their settings in the network project tree.

You can open and close the network project and instructions trees via the icons  or .

2.6.2 Network view

The network view is the working space for configuring the network and displays all the devices you have added to the network. You can add/delete devices, configure the settings of each device and set the Ethernet connections in the network view.

















2.7 Toolbars

2.7.1 Standard toolbar overview

The icons of the standard toolbar provide quick access to commands that are also available on the menu.



The following commands are found in the standard toolbar:

	File:	New (Page 47)
		Open (Page 47)
		Close (Page 48)
		Save (Page 49)
		Print (Page 51)
	Edit:	Delete (Page 59)
		Cut (Page 59)
		Copy (Page 60)
		Paste (Page 60)
		Undo (Page 59)
		Redo (Page 59)
	Tools:	Start LOGO! Mode (Page 77)
		Stop LOGO! Mode (Page 77)
		PC → LOGO! (Download) (Page 75)
		LOGO! → PC (Upload) (Page 76)
	Help:	Context-sensitive help (Page 125)

2.7.2 Simulation toolbar and status window

The toolbar





When you open simulation mode, LOGO!Soft Comfort displays the simulation toolbar, which contains the following icons.

- Icons (for example, switches) for operator control of the inputs (Page 141)
- An icon for the simulation of a power failure (Page 143) , for testing the switching response with reference to retentivity characteristics after power failure
- Icons (for example, bulbs) for monitoring outputs (Page 142)
- Simulation control icons
- Time control icons
- Data Table icon







Click "<<" to hide a partial area of the toolbar. To show this area again, click ">>".

Simulation control icons

	Start simulation
	Stop simulation
	Hold simulation (pause)
	Simulate network. If no IP address is configured for a circuit program in LOGO!Soft Comfort, the network simulation icon is inactive (grey-colored).
	Show message window

Time control icons

If you have programmed a time-sensitive circuit, you can use the time control to monitor the reaction of your circuit program.

	Start simulation for a specific time or number of cycles. Set the period and the number of cycles using the following icons.
	Set the period and the time base for a time-limited simulation or set a specific number of cycles
	Display the current time in LOGO!Soft Comfort
	Modify the current time in LOGO!Soft Comfort

Data Table icon



You can view VM (Variable Memory) values in a data table. For simulation, the values are updated each cycle. For online test, the values are updated after each communication.

Status display

Prerequisite: You can enable the display of signal states and process variables with the Tools → Options: Simulation (Page 121) command.

The colored indication identifies the "1" or "0" status of a connecting line. By default, connection lines carrying a "1" signal are red while the lines carrying a "0" signal are blue.

Example for the FBD Editor:

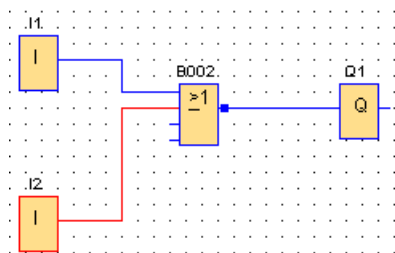

PI controller trend view

If your circuit program includes one or more PI controller function blocks, the simulation displays a trend view window of the analog output that shows the change in the AQ and PV values relative to the SP parameter over time. The trend view is continually updated while the simulation is in progress, at the frequency of the sample period that you configure. You



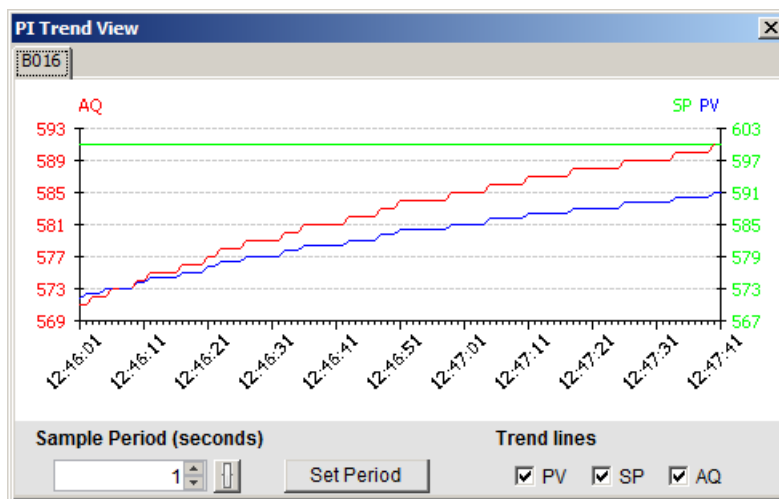







can enable or disable the individual displays of the AQ, PV, and SP trend graphs as you choose.





















If your circuit program has more than one PI controller function block, the trend view has a separate tab for each PI controller.

2.7.3 Programming toolbar

The programming toolbar contains integral icons for creating, editing and testing programs. Each one of these tools represents a programming mode, in which mouse operations have different effects.

	Edit:	Selection tool (Page 38)
		Connector tool (Page 39)
		Cut/Join connection (Page 39)
		Text tool/insert comments (Page 39)
	Format:	Align Automatically (Page 61)
		Align Vertically (Page 60)
		Align Horizontally (Page 60)
		Horizontally Distribute Space (Page 61)
		Vertically Distribute Space (Page 61)
		Bring to Front (Page 63)
		Send to back (Page 63)

	Edit	Undo (Page 59)
		Redo (Page 59)
		Constants and Connectors (Page 191)
		Basic functions (FBD and UDF editors only) (Page 207)
		Special functions (Page 212)
		Data Log Profile (Page 339)
	View:	Undo split (Page 122)
		Split into two windows (Page 123)
		Split into three windows (Page 123)
		Zoom in (Page 69)
		Zoom out (Page 69)
		Select Lines (Page 68)
	File:	Page Layout (Page 39)
	Tools:	Circuit program conversion (Page 40)
		Simulation (Page 95)
		Online test (Page 41)
		Hidden parameter box line (Page 43)
		Expand all parameter box (Page 43)
		Collapse all parameter box (Page 43)

2.7.3.1 Selection tool



You can use the selection tool to select and move blocks, text and connecting lines. You can select objects individually with a left-click; you can select multiple objects with [Ctrl]+Click, or you can use the mouse as a "lasso" to surround objects with a rectangle and capture them as a selection.

You can call the selection tool in any other tool by pressing the [ESC] key or by clicking on the icon in the programming toolbar.

Selecting objects (Page 136)

2.7.3.2 Connector tool



You can use this tool to connect blocks. To do so, move the mouse pointer to a block input or output and press the left mouse button. Keep the mouse button pressed and drag the mouse pointer from your selected source terminal to the target terminal. Now release the mouse button to anchor the connecting line to both terminals. LOGO!Soft Comfort displays the connecting lines as a straight line between the first terminal and the mouse pointer while you are dragging the mouse. Once you anchor the connection line, LOGO!Soft Comfort displays the connection line as a combination of horizontal and vertical lines, which you can manipulate using the selection tool (Page 38).

For more information on how to connect the blocks, refer to Connecting blocks (Page 130) .

2.7.3.3 Cut/Join



You can use this tool to cut and join connections between blocks. Left-click the Cut/Join icon to activate the tool. To cut a connection, left-click the relevant line while the Cut/Join tool is active. When you cut a connection of two blocks, a reference to the partner block appears beside each of the block. The reference displays the page number, block number and the I/O of the partner block.

Cut connections (Page 137)

2.7.3.4 Text tool



You can use this tool to insert or edit user-defined text objects in the programming interface. You can create labels for specific blocks. These labels remain with the block whenever you move or delete the block. You can associate only one label per block. For each label, you can specify the font type, font size, and font color. To create an associated label, click directly on the required block when the text tool is selected.

There can only be one associated label for each block.

You can configure "Wrap Text" format for the label text figures. You can adjust the size of a text figure typically by dragging the rectangle handles. You cannot enlarge or reduce the dimension of text figures that are not in Wrap Text format.

See also Documentation of the circuit program (Page 139)

2.7.3.5 Page Layout



In the **Page Layout** tab, you can specify how and on how many pages to print your circuit program. You can preview the pagination in this tab. If you choose more than one program page, LOGO!Soft Comfort indicates the page breaks with green lines. When you subsequently print the circuit program, LOGO!Soft Comfort uses this pagination. Note that connections extending to other pages are simply cut off when you print the hardcopy.

Siemens recommend you create cross-references by splitting the file at this position with the help of the Cut/Join tool (Page 39). In the File → Page Setup (Page 51) menu you can specify the paper size, page alignment and margins.

The total number of pages(horizontal x vertical) must not exceed 100.

The standard toolbar (Page 34) also contains an icon for this menu command.

2.7.3.6 Conversion tool



Use this function to convert your circuit program between LAD and FBD.

The following rules apply to the conversion from LAD to FBD:

- A series circuit of contacts is converted into an AND block.
- A parallel circuit of contacts is converted into an OR block.
- User-defined comments are not included, as their position in the circuit program cannot be defined based on blocks.
- Crosslinks (connections where a block output is connected to multiple block inputs and at least one of the inputs is connected to multiple block outputs) are converted into an OR block.

Inputs for the OR block are all block outputs of the crosslink.

The output of the OR block is connected to all block inputs of the crosslink.

- Internal flags are resolved, and the current paths are linked.



This function is inactive in the UDF Editor.

Use this function to convert your circuit program between FBD and LAD.

- An AND block is converted into a series contact circuit
- An OR block is converted into a parallel contact circuit
- Comments for basic functions are not applied in LAD, as a basic function is converted into multiple contacts. Thus, the comment cannot be assigned definitely.
- In LAD, input comments are assigned to all contacts of this input.
- User-defined comments are not included, as their position in the circuit program cannot be defined based on blocks.
- XOR blocks must be converted into corresponding LAD logic consisting of positive and negative contacts.

Note

When converting between LAD and FBD, the total number of blocks in your circuit program can sometimes increase. This could cause the permitted number of blocks for your LOGO! to be exceeded.

You cannot, therefore, always convert FBD programs to LAD.

Remedy: Under Tools -> Select Hardware (Page 90), select the hardware series that you are using. Start converting to LAD. Then under Tools -> Determine LOGO! (Page 90), see which hardware series is compatible with the circuit program.

If your circuit diagram contains a UDF block, you cannot use this function to convert it from FBD to LAD.

See also

Tools -> Select Hardware (Page 90)

2.7.3.7 Online test

The online test and simulation (Page 95) modes allow you to monitor the execution of your circuit program and how it reacts to the various input states.

Difference from simulation mode

In simulation mode you execute your circuit program on the PC. To do so, you do not require a LOGO!. You can preset the status of inputs on the PC.

During an online test, LOGO! executes the circuit program and you can monitor this "work" of LOGO!. The status of the inputs corresponds with the actual states at LOGO! inputs.

Prerequisite for an online test

You must link your PC to a LOGO!. LOGO!Soft Comfort uses the interface you specified in Tools → Transfer (Page 70) to link to LOGO!.

You can test a circuit program in either FBD or LAD format and you must transfer it to LOGO! for the online test.

The circuit programs in LOGO!Soft Comfort and on LOGO! must be identical. Upload the program from LOGO! to your PC, or download the program from your PC to LOGO! if necessary.

You can monitor the parameters of up to 30 blocks. The number of blocks you can monitor simultaneously decreases when you monitor blocks that contain a high number of parameters (for example, analog SFBs).

Starting the online test

Click the online test icon  in the programming toolbar.

If LOGO! is in STOP, start it with the start  button.

Result: LOGO! executes your circuit program.

Switching LOGO! to STOP

If you want to stop LOGO! via LOGO!Soft Comfort, click the stop icon .



Devices of the OBA4 series and later support online tests.

Possible errors

The following types of errors can occur:

- Your LOGO! does not support the online test.
Remedy: Install a LOGO! device of the OBA4 or later series.
- The programs on your PC and on LOGO! are different.
Remedy: Upload the circuit program from LOGO! to your PC, or download the program from your PC to LOGO!.
- You are attempting to monitor too many parameters/blocks simultaneously.
Remedy: Reduce the number of simultaneously monitored parameters/blocks.
- The communication between your PC and LOGO! is down.
Remedy: Re-establish the connection.



This menu command is inactive in the UDF Editor.

2.7.3.8 Showing/hiding reference line (OBA8 only)



You can use this tool to show and hide reference line between parameter boxes. When the parameter boxes are hidden, you can press this button to show or hide the reference line between boxes.

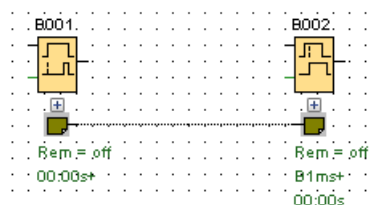

Show the reference line

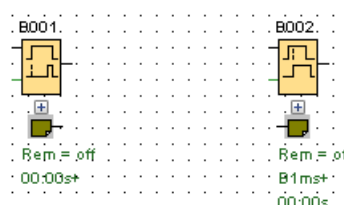

Hide the reference line

2.7.3.9 Expanding all parameter boxes (OBA8 only)



You can use this tool to expand all the parameter boxes. When you press this button, all the parameter boxes in the working circuit program are expanded.

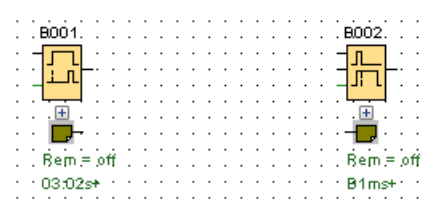

The parameter boxes are collapsed.

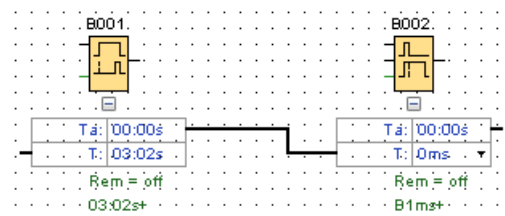

The parameter boxes are expanded.

2.7.3.10 Collapsing all parameter boxes (OBA8 only)



You can use this tool to collapse all the parameter boxes. When you press this button, all the parameter boxes in the working circuit program are collapsed.

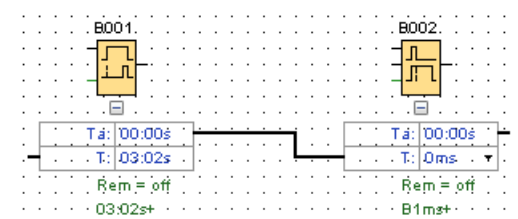



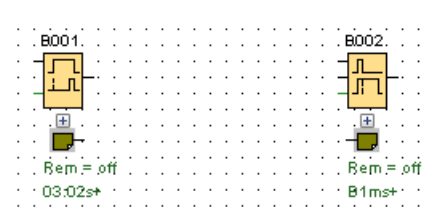

The parameter boxes are expanded.



The parameter boxes are collapsed.

2.7.4 Networking toolbar (0BA8 only)

The network toolbar appears above the Network view and contains the following icons:

-  Add new device (Page 150)
-  Go Online (Page 44)
-  Go Offline (Page 45)
-  Zoom In (Page 69)
-  Zoom Out (Page 69)

2.7.4.1 Going online (0BA8 only)



You can use this tool to test an online connection for the devices you have configured in your network project and to detect unconfigured devices in the local area network.

Note

Network requirements for going online

The **Go online** function does not work if your network is in a public or unidentified work environment. It works only when your network is in a private, home or work network environment. Make sure you set your network location correctly before going online.

For devices that are configured in a network project, you can press the **Go online** button to detect the status of each LOGO! device (0BA8 or 0BA7).

If the configured device is accessible, LOGO!Soft Comfort shows a green check mark on the top-left corner of the device image.



If the configured device is inaccessible, LOGO!Soft Comfort shows a question mark in the top-left corner of the device image.

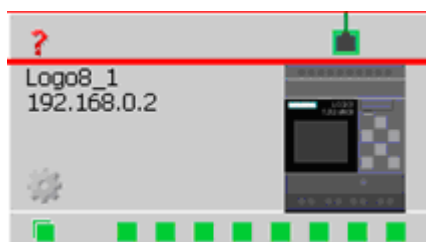

Note

To make sure the Go online function works properly, you must connect the devices to the PC in the Network view.

For devices that are in the same subnet as the selected network card and are not configured in the network project, you can press the **Go online** button to detect it and add it to the project. LOGO!Soft Comfort adds the detected device to the project as an unknown device (OBA8 only).

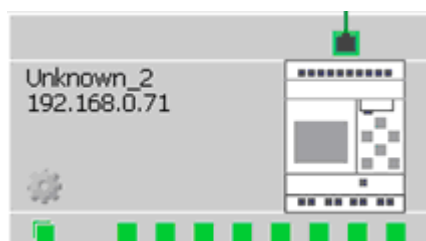

For more information on the configuration of the device, refer to Ethernet Connection Configuration (Page 157).

2.7.4.2 Going offline (OBA8 only)



Click Go offline to stop scanning online devices

Note

If you want to add an unknown device in your project, configure it after you detected it. When you click Go offline, LOGO!Soft Comfort removes all unknown devices in the network view and all the accessible status.

2.8 Menu bar

The menu bar contains administrative and editing functions for the circuit program and provides access to the context-sensitive help.

- File menu (Page 46)
- Edit menu (Page 58)
- Format menu (Page 65)
- View menu (Page 66)
- Tools menu (Page 70)
- Window menu (Page 122)
- Help menu (Page 124)

2.8.1 File menu

The File menu command contains commands for file management. Included are also commands for downloading, saving or creating circuit programs, for setting general file properties and for printing:

- New (Page 47)
- Open (Page 47)
- Close (Page 48)
- Close All Diagrams (Page 49)
- Save (Page 49)
- Save As (Page 50)
- Page Setup (Page 51)
- Print Preview (Page 51)
- Print (Page 51)
- Message Text Settings (Page 52)
- Properties (Page 53)
- Exit (Page 58)



Available in the LAD Editor only: Convert (LAD > FBD) (Page 40)
Available in the FBD Editor only: Convert (FBD > LAD) (Page 40)

2.8.1.1 File -> New



The command opens a new window with an empty programming interface for programming in LAD, FBD or UDF, depending on your set mode. Depending on your default setting, LOGO!Soft creates a window is created with a number of tabs in which you can specify the properties of the circuit program you are going to create. You can access this window later to either enter or modify the properties with the File → Properties (Page 53) menu.

An icon for this menu command is also found in the standard toolbar (Page 34).

Note

This function is only active in diagram mode.

Switching between LAD, FBD

You select the editor for creating a new circuit program from the Tools → Options: Standard Editor (Page 119) menu command.

Select either "FBD Diagram Editor" or "LAD Editor" from the Standard Editor drop-down list. LOGO!Soft Comfort creates new circuit programs in either LAD or FBD according to your selection.

2.8.1.2 File -> Open



The command opens a dialog box from which you can select and open a previously created circuit program or project for further editing. Circuit programs created in LOGO!Soft Comfort have the file extensions *.lsc, *.lld, *.bin, and *.lma. Projects created in LOGO!Soft Comfort have the file extension *.lnp. LOGO!Soft comfort opens the loaded circuit program in a new window.

The types of files that you can open are listed below:

- LOGO!Soft Comfort File FBD (*.lsc)
- LOGO!Soft Comfort File LAD (*.lld)
- LOGO! UDF File (*.lma)
- LOGO!Soft Standard File (*.lgo)
- Portable Document Format (*.pdf)
- JPG File (*.jpg)
- Bitmap File (*.bmp)
- Binary dump (*.bin)
- LSC Network Project File (*.lnp)

Note

You can open only one project in the Network view at the same time. That means if you open a new project, LOGO!Soft comfort will close the project you are editing now. If you have not saved the current project, you are prompted in a dialog to save it.

Note

The circuit diagram is always opened in diagram mode no matter you are in diagram mode or project mode. If you want to implement a circuit program on a device in your network project, right-click the device and select import in the shortcut menu.

An icon for this menu command is also available in the standard toolbar (Page 34).

Circuit programs of LOGO!Soft Standard

You can also import files created with LOGO!Soft Standard (file name extension = *.lgo). Use the "File type" menu item to select the type of file you want to display. LOGO!Soft Comfort generates a graphical layout of the circuit program.

Alternatives

You can also open a circuit program by one of the following means:

- In Windows you can also drag and drop a LOGO!Soft Comfort circuit program file to the programming interface. When you "release" this file on the diagram tree, LOGO!Soft Comfort opens it in a new window.
- In Windows you can also drag and drop a LOGO!Soft Comfort project file to the programming interface. When you "release" this file on the network project tree, LOGO!Soft Comfort opens and the project you are editing is closed.
- If you double-click a file with the extension *.lsc, *.lld, *.bin or *.lma in the file manager, LOGO!Soft Comfort automatically opens the file.

Recently-opened files

At the end of **File** menu you see a list of files that were recently opened in LOGO!Soft Comfort.

2.8.1.3 File -> Close



Click the **Close** menu command to close the active window. If you have not yet saved the current circuit program or project, LOGO!Soft Comfort prompts you to save it.

The standard toolbar (Page 34) also contains an icon for this menu command.

As an alternative, you can right-click the tab of a circuit program and select the **Close** menu command from the shortcut menu.

2.8.1.4 File -> Close All

A click on this menu command closes all open windows. If you have not yet saved one or more of the current circuit programs, LOGO!Soft Comfort prompts you to select the program to be saved in a dialog. LOGO!Soft Comfort saves all selected programs.

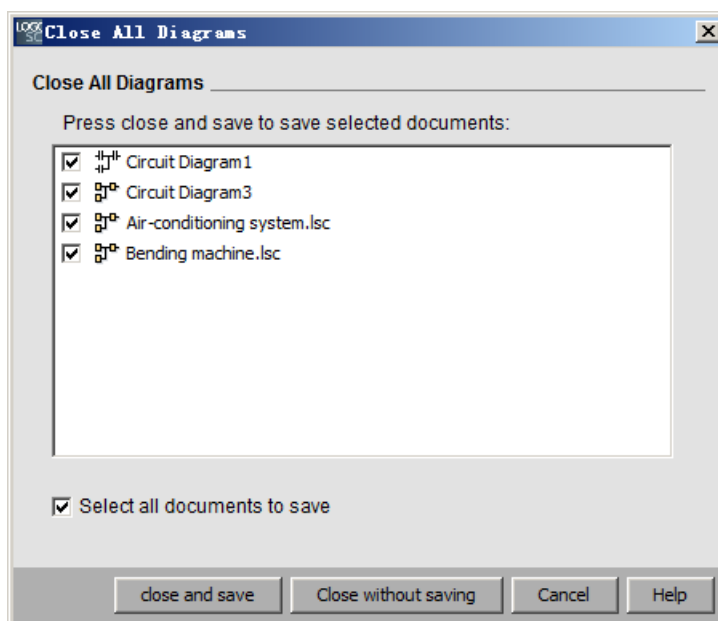

Note

A click on the **Close All** menu command in the project mode just hides the diagrams. When you click the device, its diagram opens again and all the changes you made remain.

2.8.1.5 File -> Save



When you initially save a newly created program or project, a window opens in which you can specify the path and file name under which you want to save your circuit program. You can find additional information under File → Save as (Page 50).

If you are saving a modified version of an existing program or project, LOGO!Soft Comfort performs a quick save. The revised version overwrites the old version at the same path and name as the source file.

The standard toolbar (Page 34) also contains an icon for this menu command.

As an alternative, you can right-click the tab of a circuit program and select the Save menu command from the shortcut menu.

Note

Saving a project automatically saves all of the diagrams. If you want save a diagram in the project separately, click the device it belongs and select export in the shortcut menu.

2.8.1.6 File -> Save As

A dialog opens for you to specify the path and file name under which the current circuit program or project is to be saved. This allows you to save modified programs under a different name or folder, and thus keep previous versions for retrieval.

The types of files that you can save are listed below:

- LOGO!Soft Comfort File FBD (*.lsc)
- LOGO!Soft Comfort File LAD (*.lld)
- LOGO! UDF File (*.lma)
- LOGO!Soft Standard File (*.lgo)
- Portable Document Format (*.pdf)
- JPG File (*.jpg)
- Bitmap File (*.bmp)
- Binary dump (*.bin)
- LSC Network Project File (*.lnp)



Binary dump file is only for FBD programs to be saved on an SD card: (*.bin)

The default LOGO!Soft Comfort file name extension is *.lsc for FBD programs, *.lld for LAD programs, or *.lma for UDF programs. You can also export your program to an older LOGO!Soft version if you select the file type *.lgo, the program format of LOGO!Soft Standard. LOGO!Soft Comfort does not save graphical information about block positions when you save your program. If your circuit program contains functions not supported in LOGO!Soft Standard, LOGO!Soft Comfort generates an export error message.

You can also save the circuit program in a graphical format: *.jpg, *.bmp or *.pdf. However, note that such files do not contain logic elements; you cannot reopen them in LOGO!Soft Comfort.

The PDF file offers a special feature. Saving your circuit program in *.pdf format gives you an AcrobatReader document that is easily distributable. For example, you could distribute this document to users who do not have LOGO!Soft Comfort, and thus enable them to view your project in AcrobatReader and make hard copies.

As an alternative, you can right-click the tab of a circuit program and select the **Save as** menu command from the shortcut menu.

2.8.1.7 File -> Page Setup

This command opens a dialog box in which you can specify the page settings for creating circuit programs. Here you can specify the paper format, page margins or whether to print in portrait or landscape format.

LOGO!Soft Comfort offers multi-page printout feature, with the position of page breaks indicated on-screen. The print area is user-definable.

You can paginate your circuit program via the menu command File → Properties (Page 53).

To set the printers, select the File → Print (Page 51) menu command. Finally, you can specify the scope of your hard copy with Tools → Options: Print (Page 120).

2.8.1.8 File -> Print preview

The print preview option shows what a hard copy of your circuit program looks like. You can choose the relevant icons to scroll the pages. You can also click the "Zoom In" or "Zoom Out" button, which allows you to zoom in or out per 25% increments. You can also print directly from the preview dialog.

2.8.1.9 File -> Print



This command opens a dialog with which you can select the information to print. You can also open this dialog from the Tools → Options: Print (Page 120).

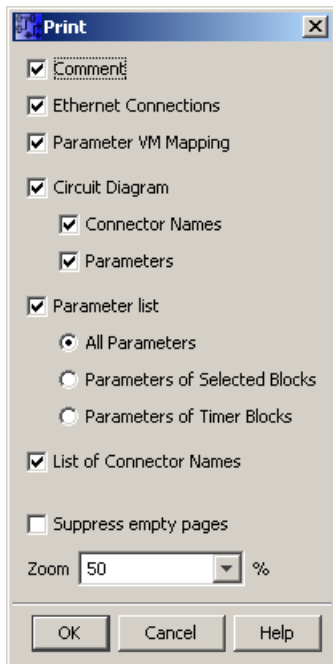

Note

The first option refers to comments that you input in the "Comment" tab of "Properties" dialog. Refer to "File -> Properties - Additional info (Page 57)" for further information.

The last option allows you to exclude pages that do not contain any graphical objects. If you exclude empty pages, your printout will have gaps in the page numbering where the blank pages were.

In the printer dialog, you can specify your default printer and the print properties. In the control panel of your computer you can specify advanced printer settings.

The AcrobatReader *.pdf format provides a further print option. You can save your program in AcrobatReader document format and distribute it to users who do not have LOGO!Soft Comfort and can then use AcrobatReader to view and print out your circuit program.

The standard toolbar (Page 34) also contains an icon for this menu command.

Set the page format under File → Page Setup (Page 51)

2.8.1.10 File -> Message Text Settings

Use this command to configure message text settings that apply to all message texts:

- Character Set 1: This specifies the primary character set for message texts. Message texts can be composed from characters from either Character Set 1 or Character Set 2. Either character set can be the default for configuring message texts.
- Character Set 2: This specifies the secondary character set for message texts. Message texts can be composed from characters from either Character Set 1 or Character Set 2. Either character set can be the default for configuring message texts.

- Analog input filter timer: This time determines the frequency at which LOGO! refreshes the analog values in a message text. The value is in milliseconds.
- Ticker Timer Setting: For messages that tick, the ticker timer determines how fast or slow a message text ticks or scrolls on the LOGO! onboard display or LOGO! TD/LOGO! TDE. The value is in milliseconds, and you can use the adjacent button to access a scroll bar to set the ticker timer.

Supported character sets

LOGO!Soft Comfort, the LOGO! onboard display, and the LOGO! TD support the following character sets:

Character Set in LOGO!	Common Name	Support Languages	Internet Reference
ISO-8859-1	Latin-1	English German Italian Spanish (partly) Dutch (partly)	http://en.wikipedia.org/wiki/ISO/IEC_8859-1
ISO-8859-5	Cyrillic	Russian	http://en.wikipedia.org/wiki/ISO/IEC_8859-5
ISO-8859-9	Latin-5	Turkish	http://en.wikipedia.org/wiki/ISO/IEC_8859-9
ISO-8859-16	Latin-10	French	http://en.wikipedia.org/wiki/ISO/IEC_8859-16
GB-2312/GBK	Chinese	Chinese	http://en.wikipedia.org/wiki/GB2312
Shift-JIS	Japanese	Japanese	http://en.wikipedia.org/wiki/Shift-jis

See the message text function (Page 315) description for details on how these settings apply.



The function for configuration message texts is inactive in the UDF Editor.

See also

Message text (LOGO! 0BA4 and LOGO! 0BA5) (Page 327)

2.8.1.11 File -> Properties

File -> Properties when the project window is the active window

If you select the File -> Properties menu command when the project window is the active window, LOGO! displays the "Project properties" dialog. In this dialog you configure properties such as name, author, and customer. In the Comment field, you can enter a description of the project or notes related to the project.

File -> Properties when the diagram editor is the active window

If you select the File -> Properties menu command when the diagram editor is the active window, LOGO! displays the "LOGO! settings" dialog. In this dialog, you can configure offline and online settings for LOGO!.

You can set the following parameters for an offline LOGO! Base Module:

- General (Page 54)
- Hardware type (Page 55)
- I/O settings (Page 55)
- I/O names (Page 63)
- Program password (Page 56)
- Power on (Page 57)
- Message text (Page 52)
- Additional info (Page 57)
- Statistics (Page 57)
- Comment (Page 58)

You can set the following parameters for an online LOGO! Base Module:

- Connect to LOGO! (Page 70)
- Show FW version (Page 78)
- Assign IP address (Page 79)
- Set clock (Page 80)
- Operating mode (Page 79)
- Clear program and password (Page 78)
- TD power-on screen (Page 82)
- Hours Counter (Page 85)
- Upload data log (Page 78)
- Diagnostics (Page 87)
- Summer/Winter time (Page 81)
- User profile settings (Page 83)
- Dynamic server IP filter (Page 88)
- Clock Sync with EM Switch (Page 77)

2.8.1.12 File -> Properties - General

In this tab, you can set the name and IP for your device. You can input the address, subnet mask and gateway to assign an IP to the LOGO! Base Module.

In the **Program name** field, you can enter a program name with up to 16 characters for the circuit program. After transfer, LOGO! onboard displays shows the circuit program under this name.

2.8.1.13 File -> Properties - Hardware type

This tab shows the basic information of LOGO! Basic, such as known blocks, constants/connectors, and the number of digital inputs.

2.8.1.14 File -> Properties - I/O settings

When you download the circuit program, LOGO!Soft Comfort also transfers the I/O settings to LOGO!.

With the setting ①, you can set what the analog outputs of LOGO! should be when LOGO! is in STOP mode and the range of the outputs value. Your choices are as follows.

For "Behavior of analog outputs in STOP mode", select one of the following choices:

- All outputs keep the last value
- AQ1 to AQ8 are set to values that you define

For "Set analog outputs value range type", select one of the following choices:

- 0 mA to 20 mA or 0 V to 10 V
- 4 mA to 20 mA

With the setting ②, you can choose to enable the optional AI3 and AI4 on the LOGO! 0BA6, 0BA7 and 0BA8 devices that have an option of four analog inputs. For LOGO! 0BA6, 0BA7 and 0BA8 devices that support four analog inputs, you can choose how many to use. Your choices are as follows:

- Enable 0 AIs: No AI available for use in your circle diagram.
- Enable 2 AIs: Only AI1 and AI2 corresponding to input terminals I7 and I8 are available for use in your circuit program.
- Enable 4 AIs: AI1 and AI2 corresponding to input terminals I7 and I8 are available for use in your circuit program. Additionally, AI3 and AI4 corresponding to input terminals I1 and I2 are available for use.

LOGO! 0BA8 devices support 8 analog inputs and 24 digital inputs.

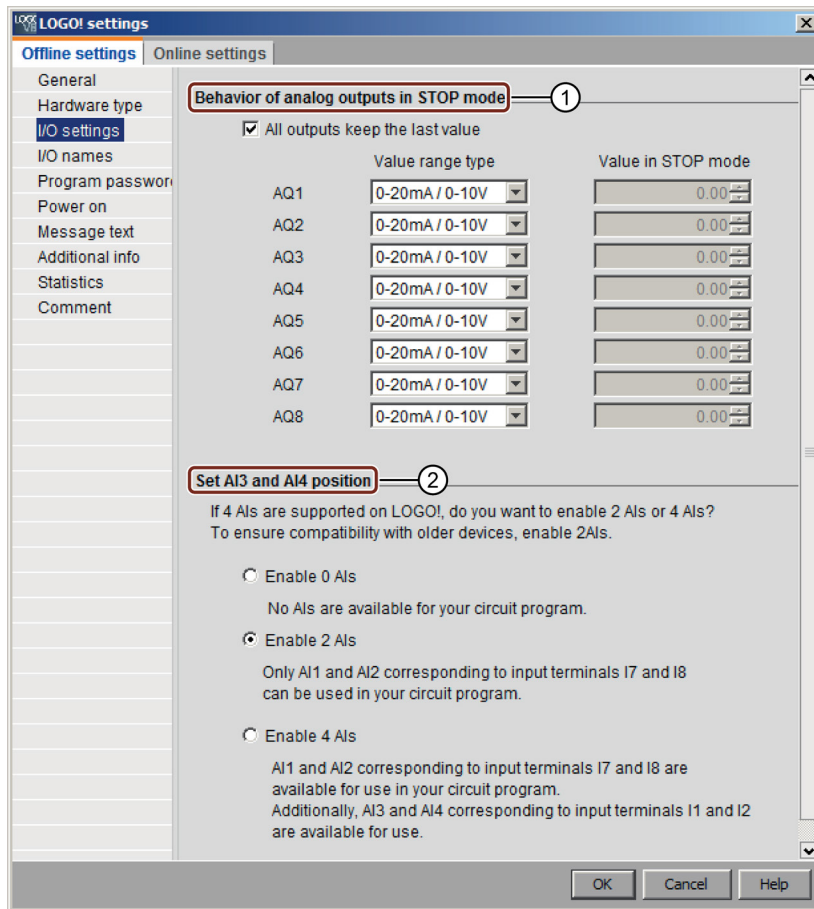

2.8.1.15 File -> Properties - Program password

When you transfer the circuit program, LOGO!Soft Comfort also transfers the password specified in **Program password** tab to LOGO!.

You can assign a password to your circuit program or change or delete an already assigned password. To assign a new password, you must enter the password in the two text boxes for **New password** and then confirm with OK. The password can have a maximum of 10 characters. To change the password, you must first enter the existing password in the **Old password** text box and the new password in the two boxes for **New password** and then confirm with OK. You can delete your assigned password at any time. To do this, enter the existing password in the box **Old password** and leave the two **New password** boxes empty. Then confirm with OK.

The password protects your circuit program on LOGO!. You can open or edit circuit programs from LOGO!Soft Comfort at any time regardless of whether the program is password-protected or not. For password-protected circuit programs, you must enter the password to view or change the program on LOGO!, or to load the circuit program from LOGO! to the computer.



The presence of tabs and fields on the Properties dialog depend on the LOGO! module that you select from the Tools → Select Hardware menu command.



This property is only for FBD and LAD Editors.

2.8.1.16 File -> Properties - Power on

When you transfer the circuit program, LOGO!Soft comfort also transfers the display content on LOGO! after power on to LOGO!.

With **Display content on LOGO! after power on** you can set what LOGO! shows on the onboard display when you switch on LOGO!. Your choices are as follows:

- Display the date and time
- Display inputs and outputs
- Display menu



The presence of tabs and fields on the Properties dialog depend on the LOGO! module that you select from the Tools → Select Hardware menu command.



This property is only for FBD and LAD Editors.

2.8.1.17 File -> Properties - Additional Info

In this tab, you can enter details of the current circuit program. This dialog includes input boxes for project-related and internal company data, as well as the version of your circuit program.

As an alternative to a text string for your company name, you can specify a *.bmp or *.jpg file with your company logo for the Company field. This feature lets you create a customized layout of your program files.



How to identify your circuit program version (Page 371)

See also

File -> Print (Page 51)

2.8.1.18 File -> Properties - Statistics

This tab shows the creation date of the circuit program and the last author.

2.8.1.19 File -> Properties - comment

In this tab, you can enter a description of the circuit program or notes relating to it. When you print your circuit program using the File → Print (Page 51) menu command, you can choose to print this comment on a separate printed page.

2.8.1.20 File -> Exit

The Exit command closes LOGO!Soft Comfort

If you are editing a circuit program or project and have not yet saved it, LOGO!Soft Comfort prompts you about your project.

In diagram mode interface you can state which circuit programs are to be saved. Alternatively, you can exit LOGO!Soft Comfort without saving circuit programs. To do this, click **Close without saving**. In the network project interface, you can click **Yes** to save the project or click **No** to exit without saving it.



A quick way of closing LOGO!Soft Comfort without saving the data (Page 372)

2.8.2 Edit menu

The Edit menu provides commands for editing your circuit program. The programming toolbar contains some of the basic commands for creating and editing circuit programs.

- Undo (Page 59)
- Redo (Page 59)
- Delete (Page 59)
- Cut (Page 59)
- Copy (Page 60)
- Paste (Page 60)
- Align - Align vertically (Page 60)
- Align - Align horizontally (Page 60)
- Align - Horizontally distribute space (Page 61)
- Align - Vertically distribute space (Page 61)
- Align - Align automatically (Page 61)
- Select All (Page 62)
- Go to block (Page 63)
- Bring to front (Page 63)
- Send to back (Page 63)
- Input/output names (Page 63)

- Block properties (Page 64)
- Block properties (all blocks) (Page 64)
- Cut connections (Page 121)
- Edit UDF properties (Page 65)

2.8.2.1 Edit -> Undo



This command allows you to undo the previous actions. Position your mouse pointer on the undo menu command and hold it there briefly. The tooltip (Page 68) opens and shows you the actions you can undo by clicking the menu item. You can undo up to 30 actions.

The standard toolbar (Page 34) and programming toolbar (Page 37) also contain an icon for this menu command.

2.8.2.2 Edit -> Redo



This command reverts the last undo action. Click the menu command to view the tooltip (Page 68) for the action to be redone.

The standard toolbar (Page 34) and programming toolbar (Page 37) also contain an icon for this menu command.

2.8.2.3 Edit -> Delete



The command deletes selected objects, without copying them to the clipboard. You can retrieve deleted objects with the **Undo** function.

If you want to delete a device in project mode, a window opens upon delete. You can confirm the deletion with **Yes** or cancel the deletion with **No** or **cancel** in the window.

The standard toolbar (Page 34) also contains an icon for this menu command.

2.8.2.4 Edit -> Cut



The command deletes one or more selected objects, for example, blocks and/or connecting lines, from the programming interface and copies them to the clipboard.

The standard toolbar (Page 34) also contains an icon for this menu command.

Note

You cannot cut the device in Network project interface.

2.8.2.5 Edit -> Copy



Use this command to copy one or more selected objects, for example, blocks, text, device, or connecting lines, to the clipboard.

The standard toolbar (Page 34) also contains an icon for this menu command.

2.8.2.6 Edit -> Paste



The command copies the clipboard content to the programming interface. LOGO!Soft Comfort distributes the devices evenly on the right of the existing devices. LOGO!Soft Comfort inserts the objects at the mouse location or below the objects you previously selected.

The standard toolbar (Page 34) also contains an icon for this menu command.

You can only paste the clipboard content if sufficient resources are available. Blocks require a certain amount of resources (Page 360), depending on the block type. LOGO!Soft Comfort generates an error message if your system does not provide sufficient resources.

You cannot paste connecting lines with open ends. You can only paste connecting lines if they connect two blocks, and you copied them to the clipboard together with those blocks

2.8.2.7 Edit -> Align

This command offers various options of aligning labels and function blocks:

- Align Vertically (Page 60)
- Align Horizontally (Page 60)
- Horizontally Distribute Space (Page 61)
- Vertically Distribute Space (Page 61)
- Align Automatically (Page 61)

2.8.2.8 Edit -> Align -> Align Vertically



This command aligns the selected object vertically to the objects with the highest block number or to the object you first selected in the circuit program.

The programming toolbar (Page 37) also contains an icon for this menu command.

2.8.2.9 Edit -> Align -> Align Horizontally



This command aligns the selected object horizontally to objects with the highest block number or to the object you first selected in the circuit program.

The Programming toolbar (Page 37) also contains an icon for this menu command.

2.8.2.10 Edit -> Align -> Horizontally Distribute Space



Use this command to set the horizontal space between objects you select. After you select this menu command, the following dialog appears:

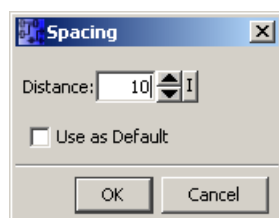

You can choose the distance from 10 or 3000 pixels, in increments of 5 pixels. You can also select the "Use as Default" check box to set the default distance.



The programming toolbar (Page 37) also contains an icon for this menu command.

2.8.2.11 Edit -> Align -> Vertically Distribute Space



Use this command to set the vertical space between the objects you select.

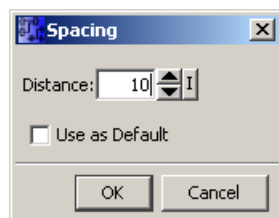

You can also choose the distance from 10 to 3000 pixels, in increment of 5. You can also select the "Use as Default" check box to set the default distance.

The programming toolbar (Page 37) also contains an icon for this menu command.

2.8.2.12 Edit -> Align -> Align Automatically



Use this command to align the selected objects automatically in vertical and horizontal direction. LOGO!Soft Comfort aligns slightly offset or adjoining blocks along a common line. The reference for vertical alignment is the relevant upper block of a column. The reference for horizontal alignment is the block at the extreme left of a line.

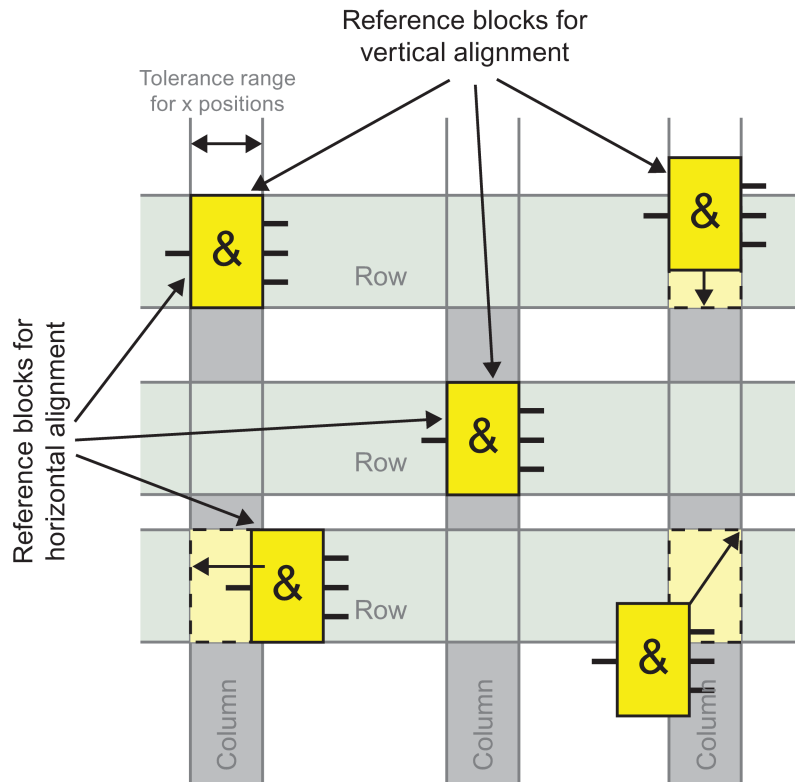

The programming toolbar also contains an icon for this menu command.

2.8.2.13 Edit -> Select all

You can use this command to select all objects (blocks, connecting lines and labels) on the programming interface.

Note

The network project interface doesn't include this function.

2.8.2.14 Edit -> Go to block

You can use this command to view a list of all blocks used in a circuit program, including information about the block number, block name and block type. By default, LOGO!Soft Comfort sorts the blocks in the list by type. You can also sort the blocks by name or number. LOGO!Soft Comfort supports fuzzy search for blocks. You can enter a short description, for example, *p?, in the searching field. Then LOGO!Soft Comfort lists all the blocks whose names contain the letter **p**. Here, "*" indicates a string and "?" indicates a character.

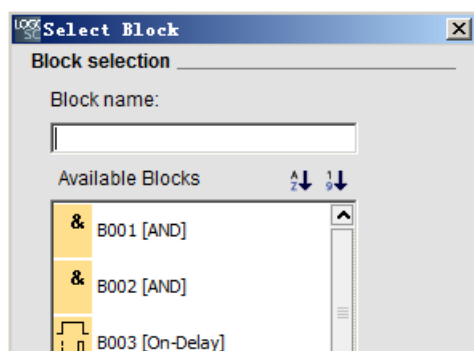

You can also select a block from the list directly to highlight it on the programming interface.

2.8.2.15 Edit -> Bring to front

You can use this command to bring one of a number of overlapping objects to the foreground.

2.8.2.16 Edit -> Send to back

You can use this command to bring one of a number of overlapping objects to the background.

2.8.2.17 Edit -> Input/output Names

This command enables you to enter names for the input and output terminals (connector names). Use the Tools → Options → Preference (Page 120) menu command to specify whether to display the connector names on the programming interface. Use the Tools → Options → Print (Page 120) menu command to open a dialog to specify whether to include the connector names and connection list in the printed copy of your circuit program.

In the Connector Names dialog, after entering input and output terminal names, you can click the **Export** button to save the name records as a .CSV file. Also, you can click the **Import** button to import a .CSV file from your PC containing the terminal name information to LOGO!Soft Comfort.



This menu command is inactive in the UDF Editor.

2.8.2.18 Edit -> Block properties

This command displays the block properties of a block that you have selected on the programming interface.

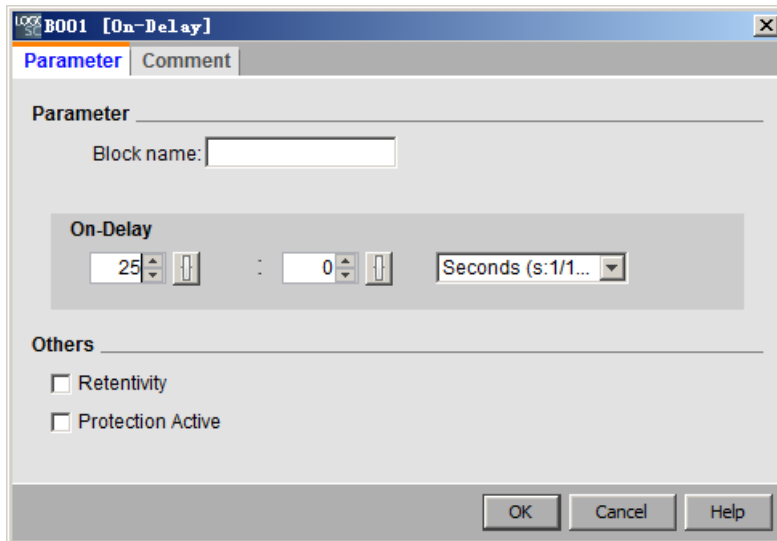

The block properties dialog box consists of several tabs. Every block has a Comment tab, where you can enter relevant block comments. For some blocks a Parameter tab is available where you can describe specific block parameters. You configure input simulation parameters from the Simulation tab.

You can also configure the block properties by right-clicking the required block, and selecting the block properties menu command from the shortcut menu.

2.8.2.19 Edit -> Block properties (all blocks)

This command opens a window with two sections. In the left section, you can see all the blocks that your program uses. Click a block to view its corresponding parameters in the right column. You can now edit these parameters and set the changes by clicking the **Apply** button.

LOGO!Soft Comfort displays the modified block in blue in the selection list, if you select another block without clicking apply button to accept the parameter changes. LOGO!Soft Comfort discards all changes you click the **Cancel** button. You can confirm all your entries and exit the dialog with **OK**.

You can sort all the available blocks by name or by number by clicking the corresponding button on the upper-right of the list area.

Here, you can also make a fuzzy search for blocks. For details, see Edit -> Go to block (Page 63).

If you select the "Select block from drawing" check box, when you select subsequent blocks from the list, LOGO!Soft Comfort highlight them in the circuit program.

Special functions (Page 212)

Basic functions (Page 207)

Constants and connectors (Page 191)

Data Log (Page 339)

UDF (Page 341)

2.8.2.20 Edit -> Edit UDF properties

Use this menu command to configure UDF (User-defined function) properties. For more information about the configuration for UDF properties, refer to "Configure UDF properties" in Editing the UDF (Page 344).



This menu command is available only in the UDF Editor.

2.8.3 Format menu

This menu provides formatting options for labels and function groups. You can define the font, the font size and style as well as the alignment of selected objects with the following menu commands.

- Font (Page 65)
- Wrap Text (Page 65)
- Format Grid (Page 66)
- Snap to Grid (Page 66)

2.8.3.1 Format -> Font

You can use this tool to specify the font type, size, style, and the text color. Perform the following steps to redefine the format of existing text objects.

1. Select the objects that you want to format.
2. Configure the font attributes.
3. Click OK to apply your configuration

You can choose to set particular default formats. Then, LOGO!Soft Comfort displays new text objects with these default settings.

2.8.3.2 Format -> Wrap Text

You can insert comments or edit user-defined text objects in the programming interface by using the Text Tool (Page 39). You can enlarge or reduce the size of a text figure, typically the figure width by dragging the rectangle handles. For example:

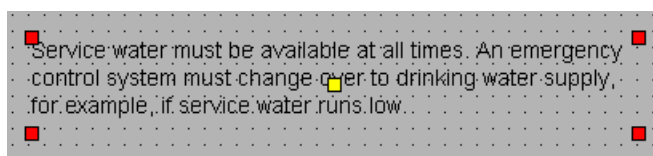

When dragging the handle of the figure above to reduce the figure width, the figure automatically shrinks to fit the width.

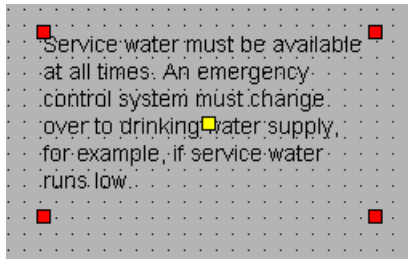

2.8.3.3 Format -> Format grid

This tool helps you to organize the various objects of your circuit program on the programming interface. The grid is visible by default.

You can adjust the grid pattern (spacing) in increments of 5 points.

If you have enabled the "Snap Block to Grid" function, LOGO!Soft Comfort aligns the objects with the relevant grid intersections. This helps you to avoid a vertical or horizontal offset of the objects. To finely position objects on your programming interface, disable the "Snap Block to Grid" function.

If you have enabled the "Snap Connection to Grid" function, LOGO!Soft Comfort aligns the connection lines between objects with the relevant grid intersections. To allow connection lines to stay unaligned with grid lines on the programming interface, disable the "Snap Connection to Grid" function.

You can hide the grid with the Visibility check box.

You can select the "Use as Default" check box to keep your settings as the default for LOGO!Soft Comfort circuit programs.

2.8.3.4 Format -> Snap to grid

If you have made changes to the grid pattern, or inserted objects while you disable the grid, the position of objects may be offset when you align them to the grid points. Use this command to correct the offset of selected objects and to realign them.

2.8.4 View menu

From the View menu, you can choose the current working mode, decide to show or hide various toolbars and trees under each mode, and set the zoom factor for the display of your circuit diagram or network project. The View menu contains the following commands.

- Diagram Mode (Page 67)
- Project Mode (Page 67)
- Toolbars (Page 67)
- Tree

- Select Lines (Page 68)
- Info Window (Page 68)
- Status bar (Page 68)
- Tooltips (Page 68)
- Zoom (Page 69)
- Zoom In (Page 69)
- Zoom Out (Page 69)

2.8.4.1 View -> Diagram mode

This command lets you hide/show the diagram mode user interface (Page 32).

The default user interface shows both diagram mode and network project.

The check mark besides the options "Diagram mode" and "Network project" indicates your current working mode. You can hide one of the modes by deselecting that mode from the user interface.

Note

You cannot deselect both modes. You must have at least one of the two modes visible as the current working mode.

2.8.4.2 View -> Network Project

This command lets you hide/show the Network project overview (Page 33).

The default user interface shows both the diagram mode and the network project.

The check mark besides the options "Diagram mode" and "Network project" indicates your current working mode. You can hide one of the modes from the user interface by deselecting that mode.

Note

You cannot deselect both modes. You must have at least one mode visible as the current working mode.

2.8.4.3 View -> Toolbar

This command lets you hide or show the standard toolbar (Page 34).

2.8.4.4 View -> Tree

This command lets you hide or show the trees on the left part of the interface:

- The diagram tree (Page 33) and the instructions tree (Page 33) under diagram mode.
- The network project tree (Page 34) and the instruction tree (Page 33) under project mode.

2.8.4.5 View -> Select Lines



With this tool, you can show all connections (lines) that lead to or away from a selected block in color.

If you select a single connection configured with this function, LOGO!Soft Comfort highlight the selected connection in color.

Also, if you select a block configured with this function, LOGO!Soft Comfort show the reference block of the selected block with its frame in red.

Under Tools > Options: Preference (Page 120) you can set whether to label the connections or not. Under Tools > Options: Colors (Page 122) you can set the colors to use to display the connections.

2.8.4.6 View -> Info Window

Use this menu command to show or hide the Info Window (Page 30). You can also use the function key (Page 31) [F4]. The Info Window lies below the diagram editor frame and at the right side of the instructions tree frame.

Note

LOGO!Soft Comfort hides the info window by default. You need to perform this command to show the info window if needed.

2.8.4.7 View -> Status Bar

Use this menu command to hide or show the status bar (Page 31).

2.8.4.8 View -> Tooltips

In LOGO!Soft Comfort, you can use the mouse-over-button function to display the icon name, which represents the tooltip.

This helps you to quickly recall the function of the icon, without having to call the menu or the help.

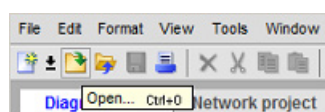

2.8.4.9 View -> Zoom

LOGO!Soft Comfort offers a variety of options for enlarging or reducing the size of the circuit program or circuit project display. By selecting Zoom, you open a dialog box in which you can set the zoom factor from a default list or in the relevant box.

If you choose an unfavorable zoom factor, the objects may appear out of focus on your screen. You should therefore use the default zoom factors wherever possible. This effect has no influence on the layout of the printed circuit program.



LOGO!Soft Comfort provides a quick and easy way of zooming your circuit program/project window. (Page 371)

2.8.4.10 View -> Zoom In



LOGO!Soft Comfort defines the zoom factor as the below defined increments:

25 (min) → 50 → 75 → 100 (default) → 150 → 200 → 250 → 300 → 400 (max)

The zooming base point differs based on what you have selected:

- With no block selected, zooming in starts from the top left corner.
- With one block selected, zooming in starts from the chosen block.
- With multiple blocks selected, zooming in starts from a central point of the chosen blocks.

The standard toolbar (Page 34) also contains an icon for this menu command.



LOGO!Soft Comfort provides a quick and easy way of zooming your diagram editor/network view window. (Page 371)

2.8.4.11 View -> Zoom Out



LOGO!Soft Comfort defines the zoom factor as the below defined increments:

400 (Max) → 300 → 250 → 200 → 150 → 100 (default) → 75 → 50 → 25 (Min)

On any occasions, zooming out always starts from the top left corner.

The standard toolbar (Page 34) also contains an icon for this menu command.



LOGO!Soft Comfort provides a quick and easy way of zooming your circuit program/project window. (Page 371)

2.8.5 Tools menu

The tools menu provides the following menu commands:

- Transfer (Page 70)
- Determine LOGO! (Page 90)
- Select Hardware (Page 90)
- Compare (Page 90)
- Simulation (Page 95)
- Simulation parameters (Page 95)
- Connect modem (Page 97)
- Disconnect modem (Page 99)
- Ethernet Connections (Page 100)
- Parameter VM Mapping (Page 105)
- Options (Page 119)

2.8.5.1 Tools -> Transfer

You can transfer data between a LOGO! Base Module and LOGO!Soft Comfort with the Transfer menu commands.

Prerequisites

To transfer data between the LOGO! Base Module and the LOGO!Soft Comfort, you must configure a communication interface.

Whenever you select a menu command in this menu, LOGO!Soft Comfort displays the Interface dialog. Use this dialog to establish communication between the LOGO! Base Module and LOGO!Soft Comfort.

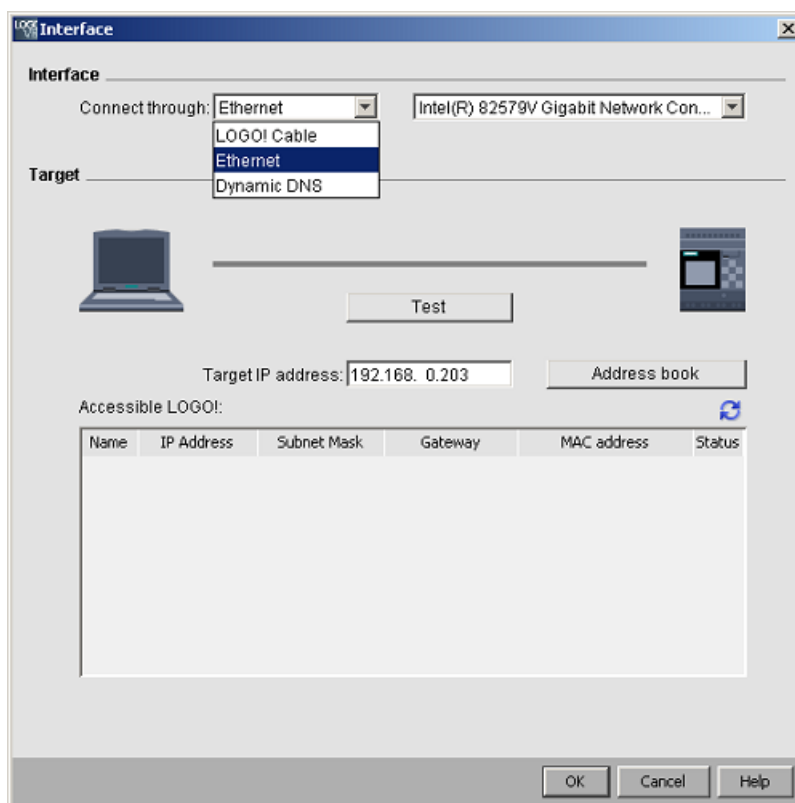

Note

For the data transfer, the LOGO! Base Module must not be in RUN mode or editing mode.

Transfer through LOGO! PC Cable (0BA6 and prior only)

For the data transfer through LOGO! PC Cable, you need to manually choose LOGO! Cable as the communication interface, and set the LOGO! COM port in the drop-down box.

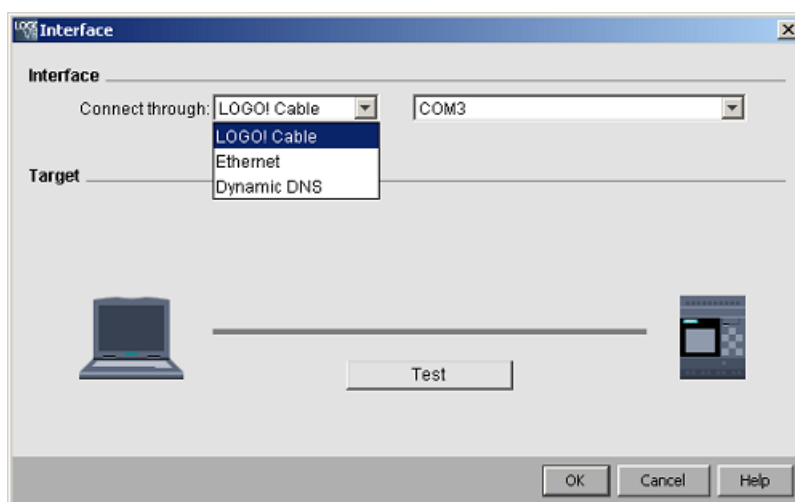

Transfer through Ethernet (OBA7 and later only)

If you select Ethernet for the communication, you can either choose a target IP address from the accessible LOGO! list or enter a known IP address.

You can also store the LOGO! information in the address book in case you need to use them in the future.

Perform the steps below to detect a valid LOGO! Base Module automatically.

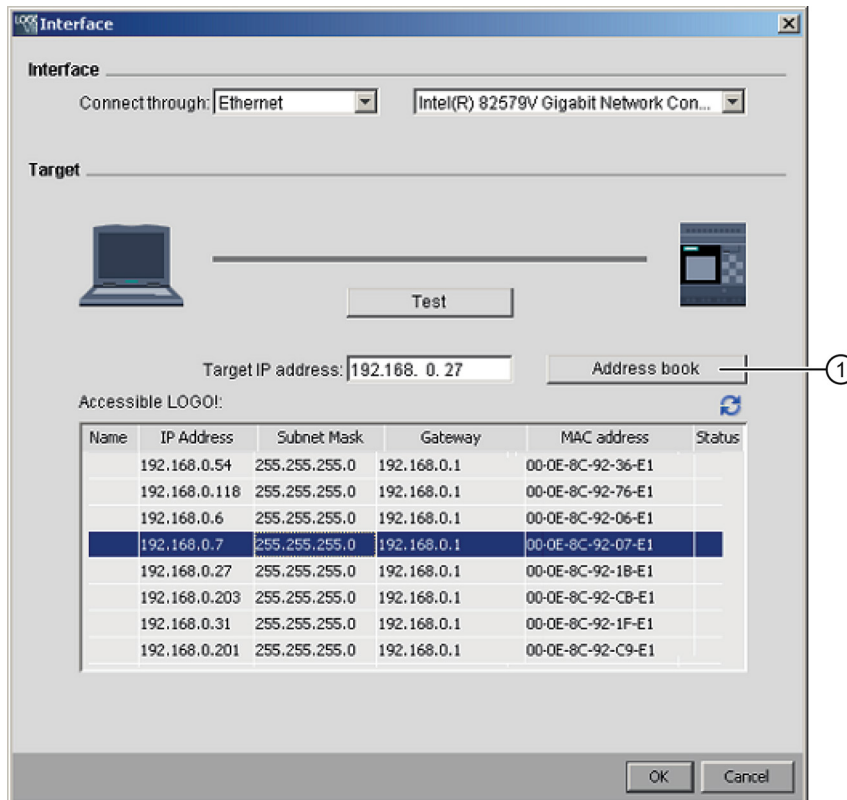

1. Click "①" on the above screen to show the address book.
2. Enter the IP address of the LOGO! Base Module.
3. Keep the default subnet address of "255.255.255.0" unchanged.
4. Enter the correct gateway IP address. Make sure you have completed this step if your LOGO! Base Module is in the same LAN (Local Area Network or not).
5. Save the item in your address book.

You can click  to acquire the new accessible LOGO! Base Module OBA8.

LOGO!Soft Comfort saves the scanned LOGO! Base Modules to the accessible LOGO! list for future use.

Transfer through Dynamic DNS (0BA7 and later only)

If you select Dynamic DNS for the communication, you can enter a known URL address or click the arrow in the URL textbox to recall an URL address you entered before:

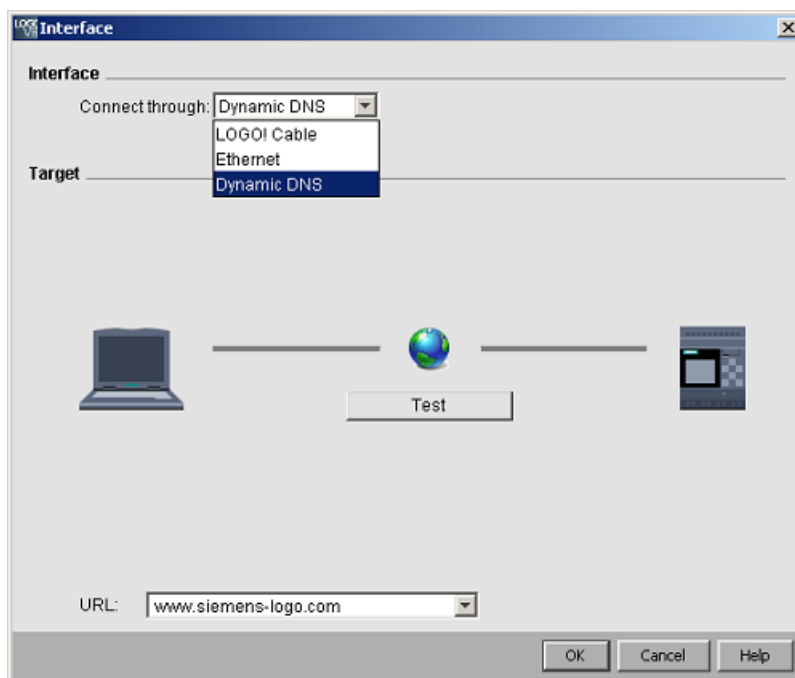

You must configure your router in order to access the LOGO! Base Module through dynamic DNS. Make sure you have completed the following settings before connection:

- The remote LOGO! Base Module has a valid dynamic DNS account for routing.
- The local router has added the dynamic DNS of the remote LOGO! Base Module as a HTTP virtual server.

Note

LOGO! 0BA8 devices communicate with a remote LOGO! Base Module in TCP protocol through private port 8080.

Connection test

After you select the desired connection interface, you can test the connection in the same dialog.

Click "①" on the following screen to check if the connection is ready.

The grey connection line turns green and you see a check mark icon above the line if your connection is successful.

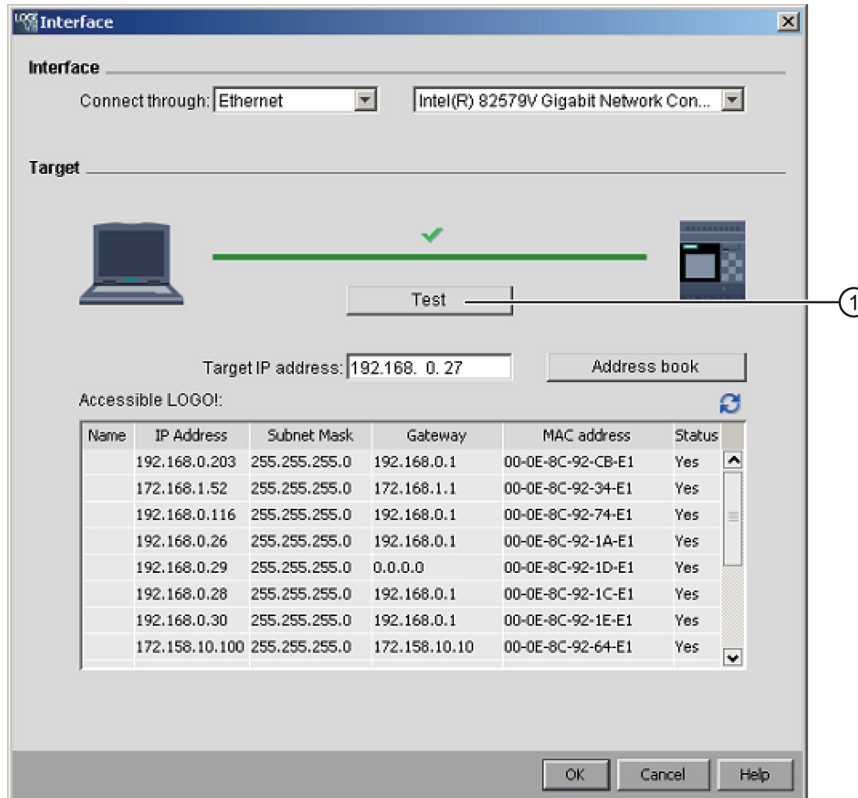

You can also copy your circuit programs to the SD card in the above screen.

Menu commands overview

The **Tools → Transfer** menu contains the following menu commands:

- Tools → Transfer: PC → LOGO! (Page 75)
- Tools → Transfer: LOGO! → PC (Page 76)
- Tools → Transfer: Start LOGO! (Page 77)
- Tools → Transfer: Stop LOGO! (Page 77)
- Tools → Transfer: Clock Sync with EM (Page 77)
- Tools → Transfer: Show FW version (Page 78)
- Tools → Transfer: Clear User Program and Password (Page 78)
- Tools → Transfer: Upload Data log (Page 78)
- Tools → Transfer: Configure Network Address (Page 79)
- Tools → Transfer: Configure Normal/Slave Mode (Page 79)
- Tools → Transfer: Set Clock (Page 80)
- Tools → Transfer: Summer time/Winter time (Page 81)
- Tools → Transfer: Set LOGO! TD Power-on Screen (Page 82)
- Tools → Transfer: Access Control (Page 83)
- Tools → Transfer: Hours counter (Page 85)
- Tools → Transfer: I/O Status (Page 86)
- Tools → Transfer: Diagnostic (Page 87)
- Tools → Transfer: Dynamic Server IP Filter (Page 88)

2.8.5.2 Tools -> Transfer -> PC -> LOGO!

LOGO!Soft Comfort requires that you confirm the connection interface for each communication attempt. See "Tools -> Transfer (Page 70)" for complete information.

 → Tools → Transfer: **PC → LOGO!**

You can use this menu command to download a circuit program created with the LOGO!Soft Comfort from PC to the LOGO! Base Module. You can also use the  button in the standard toolbar (Page 34) for such purpose.

Preparations

Prior to the download, the system determines the minimum LOGO! version required for your circuit program. The modular LOGO! always provides all available I/O resources (Page 365) for your circuit program. You are free to install an appropriate number of expansion modules in the base device.

Error messages

LOGO!Soft Comfort aborts the transfer and displays an error message if the LOGO! Base Module does not have enough resources for program transfer. The error dialog displays unknown LOGO! versions prompts you to continue or cancel the download.

The status bar displays transfer messages and the Info Window displays transfer messages as well as detailed error messages.

Layout recovery (OBA8 only)

When you download a circuit program (FBD only) to your LOGO! Base module, LOGO!Soft Comfort also downloads the program layout. The LOGO!Soft Comfort reads the layout information and recovers it automatically when you open it again.

The layout memory size in a LOGO! Basic is up to 30 KB. You can check the available memory size from the info window by determining LOGO! (Page 90) before saving a circuit diagram.

2.8.5.3 Tools -> Transfer -> LOGO! -> PC

LOGO!Soft Comfort requires that you confirm the connection interface for each communication attempt. See "Tools -> Transfer (Page 70)" for complete information.

 → Tools → Transfer: LOGO! → PC

You can use this menu command to upload a circuit program created with the LOGO!Soft Comfort from PC to the LOGO! Base Module. You can also use the  button in the standard toolbar (Page 34) for such purpose.

Cutting connections

If you have set the "Cut connections during import/upload" check box under Tools → Options: Cut connections (Page 121), LOGO!Soft Comfort cuts the relevant connections during the upload from LOGO! to the PC according to the rules set in this dialog.

Password

When you upload a password-protected circuit program from LOGO! to the PC, LOGO!Soft Comfort prompts you to enter a password. If you do not enter the correct password, LOGO!Soft Comfort aborts the transfer and displays an error message.

2.8.5.4 Tools -> Transfer -> Start LOGO!

LOGO!Soft Comfort requires that you confirm the connection interface for each communication attempt. See "Tools -> Transfer (Page 70)" for complete information.

 → Tools → Transfer → **Start LOGO!**

When you click this symbol, LOGO!Soft Comfort switches the connected LOGO! Base Module from STOP mode to RUN mode.

As an alternative approach, you can also click the button on the Standard Toolbar (Page 34).

Note

This function is only available with devices of the 0BA6 hardware series or later.

2.8.5.5 Tools -> Transfer -> Stop LOGO!

LOGO!Soft Comfort requires that you confirm the connection interface for each communication attempt. See "Tools -> Transfer (Page 70)" for complete information.

 → Tools → Transfer → **Stop LOGO!**

When you click this symbol you change the mode of a connected LOGO! from RUN mode to STOP mode.

As an alternative approach, you can also click the button on the Standard Toolbar (Page 34).

Note

This function is only available with devices of the 0BA6 hardware series or later.

2.8.5.6 Tools -> Transfer -> Synchronize clock with EM

LOGO!Soft Comfort requires that you confirm the connection interface for each communication attempt. See "Tools -> Transfer (Page 70)" for complete information.

This command allows you to either enable or disable the clock synchronization among LOGO! Base Module and its connected expansion modules.

With this command:

- You can choose to synchronize the clock of the LOGO! expansion modules to be the same as that on the LOGO! Base Module.
- You can also choose to allow different clock settings on the LOGO! Base Module and its connected LOGO! expansion modules.

2.8.5.7 Tools -> Transfer -> Show FW version

LOGO!Soft Comfort requires that you confirm the connection interface for each communication attempt. See "Tools -> Transfer (Page 70)" for complete information.

This command allows you to identify the firmware version of the LOGO! Base module.

2.8.5.8 Tools -> Transfer -> Clear User Program and Password

LOGO!Soft Comfort requires that you confirm the connection interface for each communication attempt. See "Tools -> Transfer (Page 70)" for complete information.

This command allows you to clear the circuit program in the connected LOGO! device and the program password if a password exists.

You must respond to a confirmation dialog to ensure that you do intend to clear both the circuit program and the password (if configured) from the LOGO! device. After you confirm the command, LOGO!Soft Comfort performs the clear operation. If you do not confirm the command, LOGO!Soft Comfort performs no action. The circuit program and password (if configured) remain in the LOGO! device.

Note

LOGO! devices prior to version 0BA6 do not support this function. If you attempt this command on an earlier device, LOGO!Soft Comfort displays a message that states that the device does not support this function.

2.8.5.9 Tools -> Transfer -> Upload Data Log (0BA7 and 0BA8 only)

LOGO!Soft Comfort requires that you confirm the connection interface for each communication attempt. See "Tools -> Transfer (Page 70)" for complete information.

This menu allows you to upload a data log from the EEPROM to the PC when the Base Module is in RUN mode.

You can upload your data log and browse to a desired directory and save your data log document.

LOGO!Soft Comfort uploads the file from the EEPROM and saves it as a .CSV file that you can open from Microsoft Excel or a text editor.

2.8.5.10 Tools -> Transfer -> Configure Network Address (OBA7 and OBA8 only)

LOGO!Soft Comfort requires that you confirm the connection interface for each communication attempt. See "Tools -> Transfer (Page 70)" for complete information.

With this menu command, you can change the IP address, subnet mask and default gateway of the LOGO! Base Module:

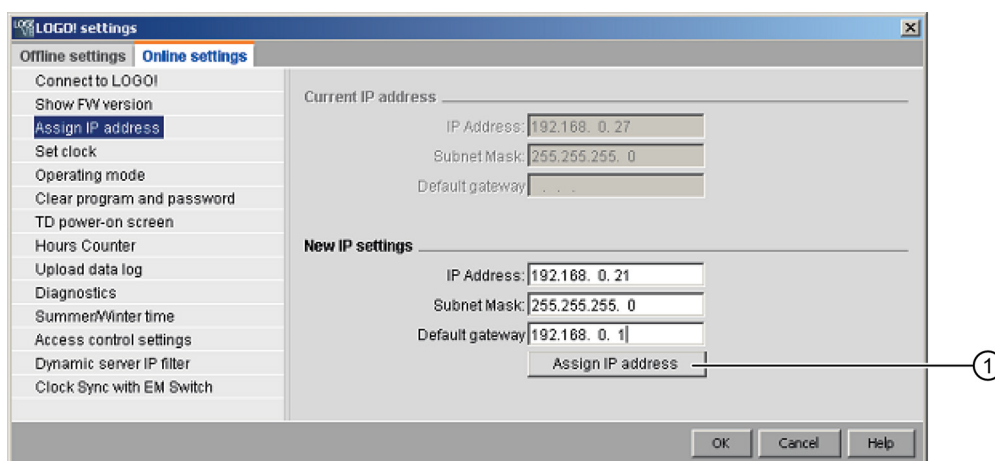

Click "①" to implement the change.

2.8.5.11 Tools -> Transfer -> Configure Master/Slave Mode (OBA7 and OBA8 only)

LOGO!Soft Comfort requires that you confirm the connection interface for each communication attempt. See "Tools -> Transfer (Page 70)" for complete information.

Use this menu command to switch a LOGO! Base Module between master mode and slave mode.

If you set the connected LOGO! Base Module to slave mode, you must enter the destination IP address of the module:

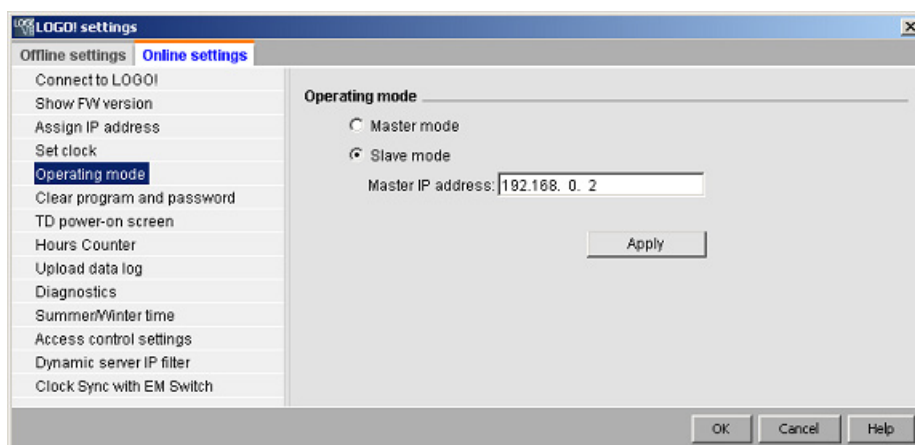

Note

LOGO! restarts automatically whenever you make the following changes in LOGO!Soft Comfort:

- Mode switch (from master mode to slave mode or vice versa)
- Change to the master IP address in slave mode

2.8.5.12 Tools -> Transfer -> Set Clock

LOGO!Soft Comfort requires that you confirm the connection interface for each communication attempt. See "Tools -> Transfer (Page 70)" for complete information.

This menu command allows you to view and set the date and time of the LOGO! Base Modules.

Setting the clock for LOGO! Base Modules

LOGO!Soft Comfort allows you to read the date and time from the PC or the LOGO! Base Module directly:

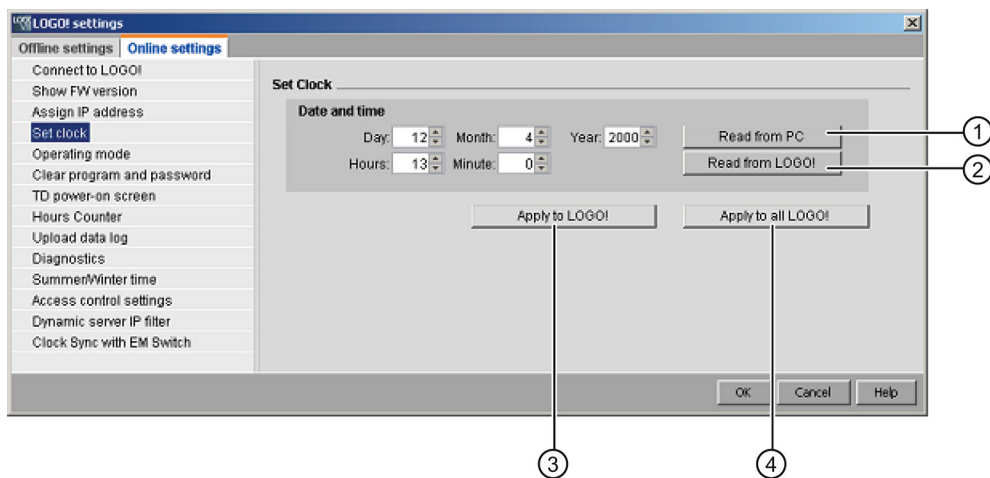

Click "①" to read the date and time from the connected PC, or to click "②" and acquire it from the connected LOGO! Base Module.

Click "③" to save the date and time displayed to the LOGO! Base Module connected with the LOGO!Soft Comfort.

Click "④" to save the date and time displayed to all the LOGO! Base Modules in the Local Area Network (LAN).

LOGO!Soft Comfort synchronizes the time and date among Base Modules in the same network segment with the local PC.

Manual input of values

You can enter the date and time values by entering in the number input box or by clicking the UP and DOWN arrow icons. LOGO!Soft Comfort automatically corrects any invalid date values.

2.8.5.13 Tools -> Transfer -> Summer time/Winter time

LOGO!Soft Comfort requires that you confirm the connection interface for each communication attempt. See "Tools -> Transfer (Page 70)" for complete information.

This menu command lets you set an automatic conversion of the summer and winter time for the LOGO! Clock:

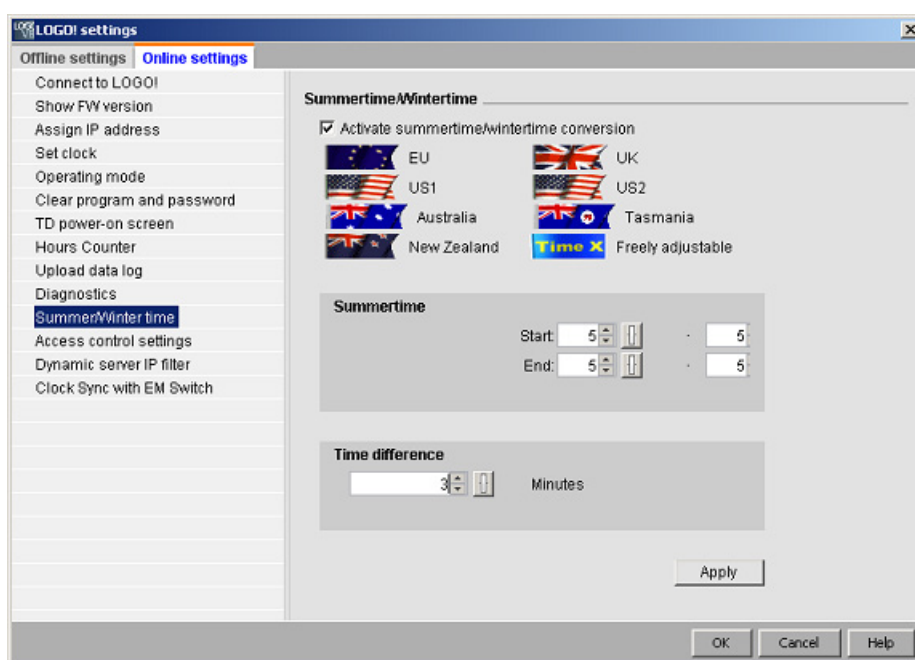

When you enable summer/winter time conversion, you can specify a country-specific time conversion:

- EU: European Union
- UK: United Kingdom of Great Britain and Northern Ireland
- US1 / US2: United States of America
- Australia
- Tasmania
- New Zealand
- Freely adjustable: customized switchover dates and times

For the "Freely adjustable" selection, you specify the month and day of the switchover. The start time of summer time is 02:00 + the entered time difference; the end time is 03:00 – the entered time difference.

The United States of America redefined the Daylight Saving Time / Standard Time calendar in 2007. US1 is the convention in effect prior to 2007 and US2 is the convention defined in 2007 where Daylight Saving Time is in effect from 2:00 a.m. on the second Sunday in March until 2:00 a.m. on the first Sunday in November according to the local time zone.

Note

LOGO! devices as of series 0BA3 and later support the summer/winter time conversion.

LOGO! devices as of series 0BA6 and later support the US2 selection.

2.8.5.14 Tools -> Transfer -> Set LOGO! TD Power-on Screen

LOGO!Soft Comfort requires that you confirm the connection interface for each communication attempt. See "Tools -> Transfer (Page 70)" for complete information.

Use this command to configure a power-on screen for the LOGO! TD/LOGO! TDE from the character set that you select:

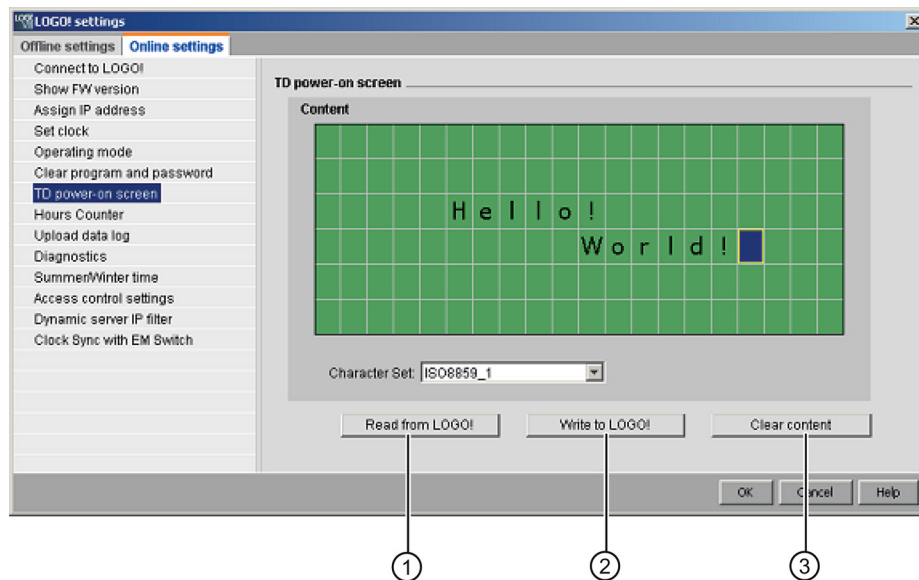

Click "①" to load the previously-configured power-on screen that is stored in the memory of the LOGO! Base Module.

Click "②" to copy the currently-configured screen to the LOGO! Base Module memory.

The LOGO! Base Module updates the LOGO! TD/LOGO! TDE with the power-on screen that stored in memory.

Select a character set for the power-on screen and then use the keyboard to type characters into the display window text edit area.

You can click "③" to switch back to empty screen.

The power-on screen can only contain simple text strings.

Note

LOGO! devices prior to version 0BA6 do not support this function. If you attempt this command on an earlier device, LOGO!Soft Comfort displays a message that states that the device does not support this function.

Copying and pasting text characters

Whenever you enter characters into the display window text edit area, you can use the keyboard shortcuts for copy (Ctrl+C) and paste (Ctrl+V). You can copy and paste characters between any documents on your computer, text in a message text, text in an I/O status name, or text in the LOGO! TD/LOGO! TDE Power-on screen text edit area. LOGO!Soft Comfort verifies that any characters to be pasted are valid for the selected character set.

You cannot use cut (Ctrl+X) to cut characters for pasting, except from a document on your computer. LOGO!Soft Comfort does not support the cut operation from the message text, I/O status name, or LOGO! TD Power-on screen editing dialogs.

2.8.5.15 Tools -> Transfer -> Access Control

LOGO!Soft Comfort requires that you confirm the connection interface for each communication attempt. See "Tools -> Transfer (Page 70)" for complete information.

Use this command to authorize access and configure passwords to user profiles on different access occasions.

When establishing communication with the LOGO! Base Module and LOGO! TD/LOGO! TDE through Ethernet or Dynamic DNS, LOGO!Soft Comfort allows four types of access approaches including:

- LOGO! smart phone application access
- LOGO! TD / LOGO! TDE access
- Remote HTTP access
- Web server access

From the access control dialog, scroll down to see all the access types and the configuration options.

Once you enable a user profile, you can then enable and set its password.

When you apply your modification, LOGO!Soft Comfort will switch your LOGO! Base Module from STOP to RUN mode.

Note

If you have enabled an access type without password change, you can log on with the default password "LOGO".

Note

Password: Protect the access with a strong password.

Strong passwords must mix letters, numbers, and special characters, are not words that can be found in a dictionary, and are not names or identifiers that can be derived from personal information. Keep the password secret and change it frequently.

LOGO!Soft Comfort supports all password inputs including letters, numbers, and special characters with ASCII character set.

LOGO! smart phone application access

Here you enable access to LOGO! Base Module and LOGO! TD/LOGO! TDE from LOGO! smart phone applications and change the logon password.

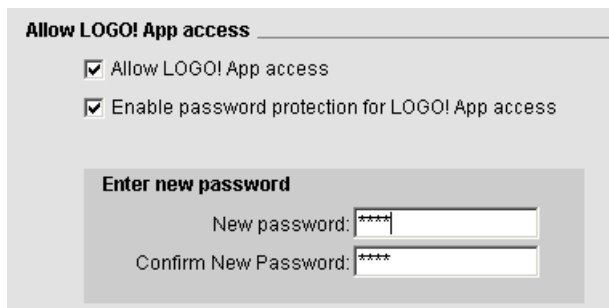

LOGO! TD/LOGO! TDE access

Here you enable access to LOGO! Base Module from LOGO! TD/LOGO! TDE and change the logon password.



Remote HTTP access

Here you enable remote access through HTTP connections and change the logon password.



The screenshot shows a window titled "Remote access". It contains two checked checkboxes: "Allow remote access" and "Enable password protection for remote access". Below these is a section titled "Enter new password" with two input fields: "New password:" and "Confirm New Password:", both containing four asterisks.

Web server access

Here you enable Web server access through Local Area Network (LAN) connections and change the logon password.



The screenshot shows a window titled "Web server access". It contains two checked checkboxes: "Allow Web server access" and "Enable password protection for Web server access". Below these is a section titled "Enter new password" with two input fields: "New password:" and "Confirm New Password:", both containing four asterisks.

For more details about the Web server, refer to the Web server section of *LOGO! Manual*.

2.8.5.16 Tools -> Transfer -> Hours Counter

LOGO!Soft Comfort requires that you confirm the connection interface for each communication attempt. See "Tools -> Transfer (Page 70)" for complete information.

Use this menu command to read the hours counter of the connected LOGO!.

See Hours counter (Page 249) for more information.

You can also access the hours counter from the LOGO! devices. You do not have to enter a password to read the hours counter even when the target program is password-protected.

Note

Only the LOGO! devices of 0BA3 and later versions support this function.

2.8.5.17 Tools -> Transfer -> I/O Status (OBA7 and OBA8 only)

LOGO!Soft Comfort requires that you confirm the connection interface from the "Interface" dialog for each communication attempt. See "Tools -> Transfer (Page 70)" for complete information.

Use this menu command to display and save I/O status information:

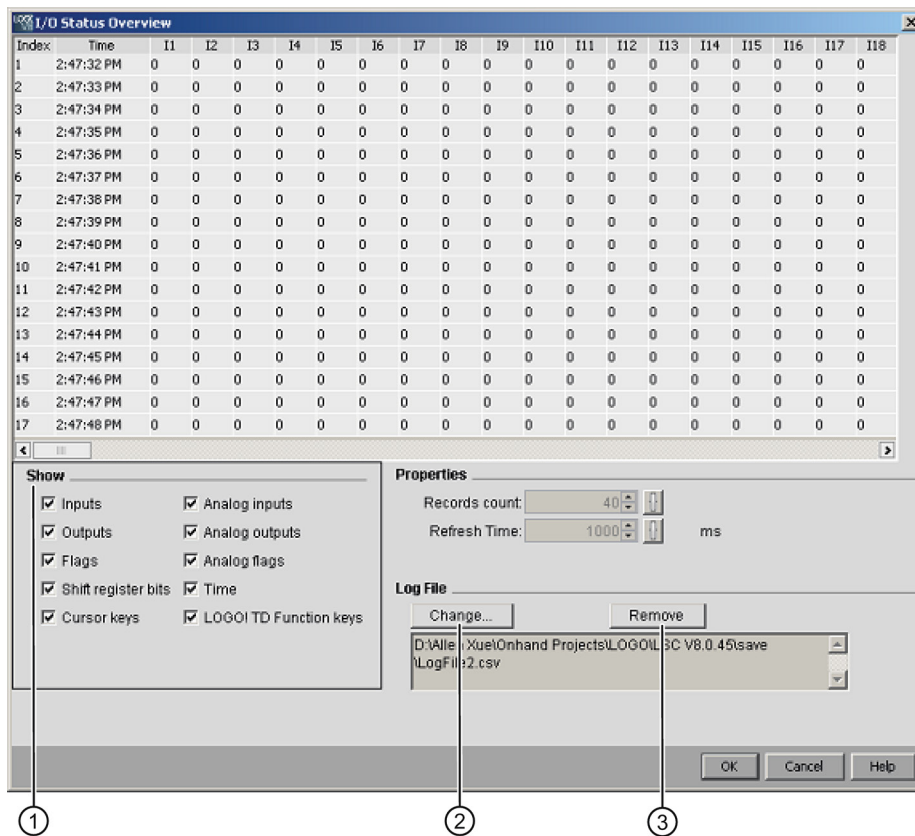

Configuring the status display

Under "1" in the screen above, you can select which I/O to display in the status window.

Configuring the status display properties

Here you can define the maximum number of status records. You can choose from 20 to 100.

Here you can also define the interval between I/O status refreshes. You can choose a refresh time from 500 ms to 30000 ms.

Configuring the log file

You can export all I/O status information to a .CSV file. You can change or remove the path for saving the log file.

To save the I/O status information to a .CSV file, follow these steps:

1. Click "②" in the screen above and specify a path for saving the log file.
2. You can also remove the log file if you click "③" in the screen above.
3. Save the I/O status information to the specified log file.

If you do not specify a log file, LOGO!Soft Comfort closes the I/O Status Overview without saving it to a file.

2.8.5.18 Tools -> Transfer -> Diagnostic (0BA7 and 0BA8 only)

LOGO!Soft Comfort requires that you confirm the connection interface from the "Interface" dialog for each communication attempt. See "Tools -> Transfer (Page 70)" for complete information.

The diagnostic function tracks the following types of basic error information:

- LOGO! Base Module 0BA7:
 - Network access errors
 - Expansion module bus errors
 - SD card read/write errors
 - SD card write protection
- LOGO! Base Module 0BA8:
 - Ethernet link errors
 - Expansion module changed
 - SD card read/write errors
 - SD card does not exist
 - SD card is full

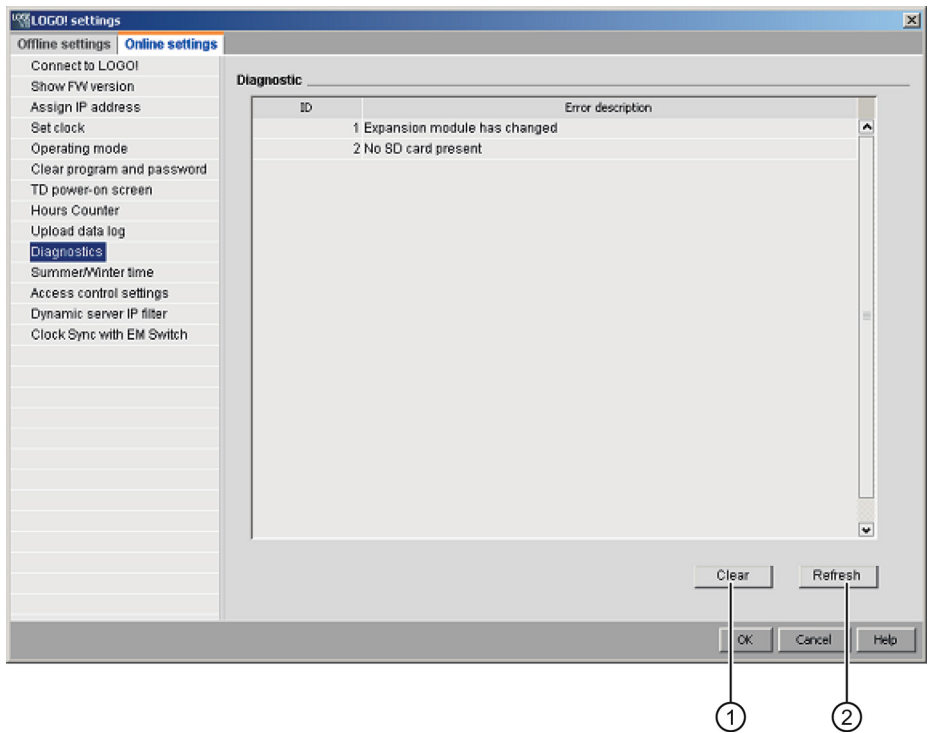

You can use this LOGO!Soft Comfort command to get the error information.

By clicking "①", you can delete all the error records you selected. By clicking "②", you can get the latest error information of the connected Base Module.

2.8.5.19 Tools -> Transfer -> Dynamic Server IP Filter (OBA8 only)

LOGO!Soft Comfort requires that you confirm the connection interface for each communication attempt. See "Tools -> Transfer (Page 70)" for complete information.

Use this menu command to show and configure the ACL (Access Control List) of the connected LOGO! Base Module:

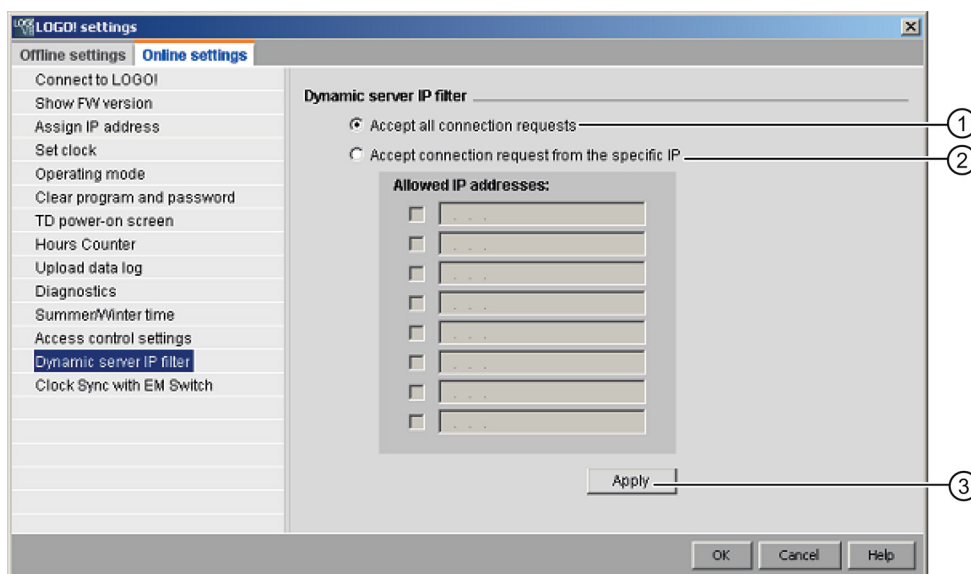

If you click checkbox "①", LOGO! Base Module allows access requests from all IP addresses.

If you click checkbox "②", LOGO!Soft Comfort provides an allowed IP addresses list of eight check boxes, each with an IP address input box for IP filtering configurations.

Click a checkbox in the list, input the IP address of the LOGO! Base Module and click "③" to authorize its access:

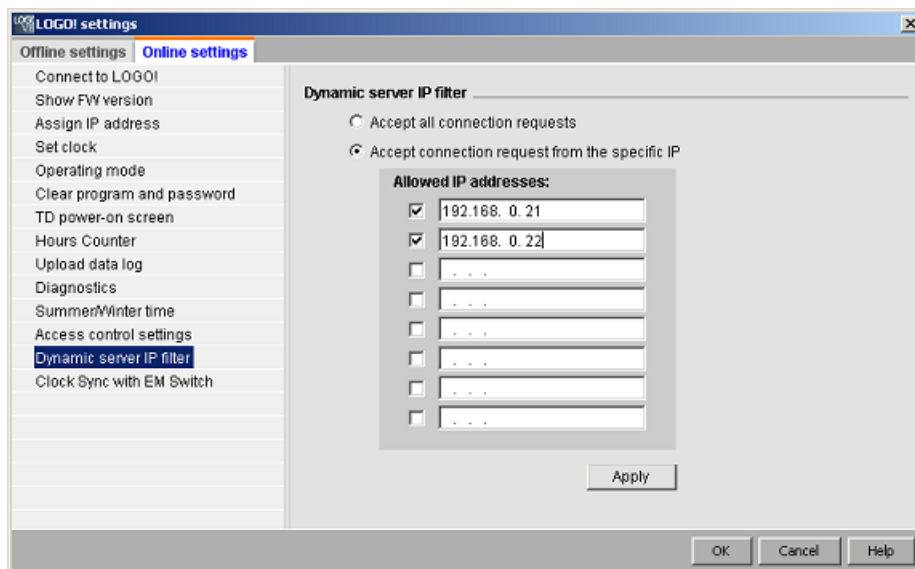

2.8.5.20 Tools -> Determine LOGO!

When you click this menu command, LOGO!Soft Comfort calculates the minimum LOGO! version requirements for the LOGO! circuit program. LOGO!Soft Comfort shows the result in the status bar (Page 31). The info window displays all versions to which you can download the program. You can also use the function key (Page 31) [F2] to execute this menu command.

2.8.5.21 Tools -> Select Hardware

You have two options of selecting the device when you create your program or project in LOGO!Soft Comfort:

- You can first create your program or project and then determine the required LOGO! by using the **Tools → Determine LOGO!** (Page 90) dialog.
- You can first determine the LOGO! version for which you want to create your circuit program or project by calling the **Tools → Select Hardware** dialog. You can also select the device by double-clicking the LOGO! icon in the status bar.

The device selection dialog shows you all the blocks and memory resources available.

If your program contains certain blocks with special functionalities, the hardware selection dialog offers you only the LOGO! device compliant with these blocks.

If you are working on a network project, the hardware selection dialog offers you only the LOGO! devices that support Ethernet connections.

2.8.5.22 Tools -> Compare

You can use this function to compare two circuit programs.

LOGO!Soft Comfort does not recognize differences in the graphical block layout and in comments.

Overview

You can use this function to compare two circuit programs. You can either compare two circuit programs that are both open in LOGO!Soft Comfort, or you can compare a program in LOGO!Soft Comfort with the other one in the LOGO! device.

Note

You can compare only circuit programs of the same type, that is: *.lsc with *.lsc, *.lld with *.lld, or *.lma with *.lma.

The following screenshot provides an overview of the compare dialog.

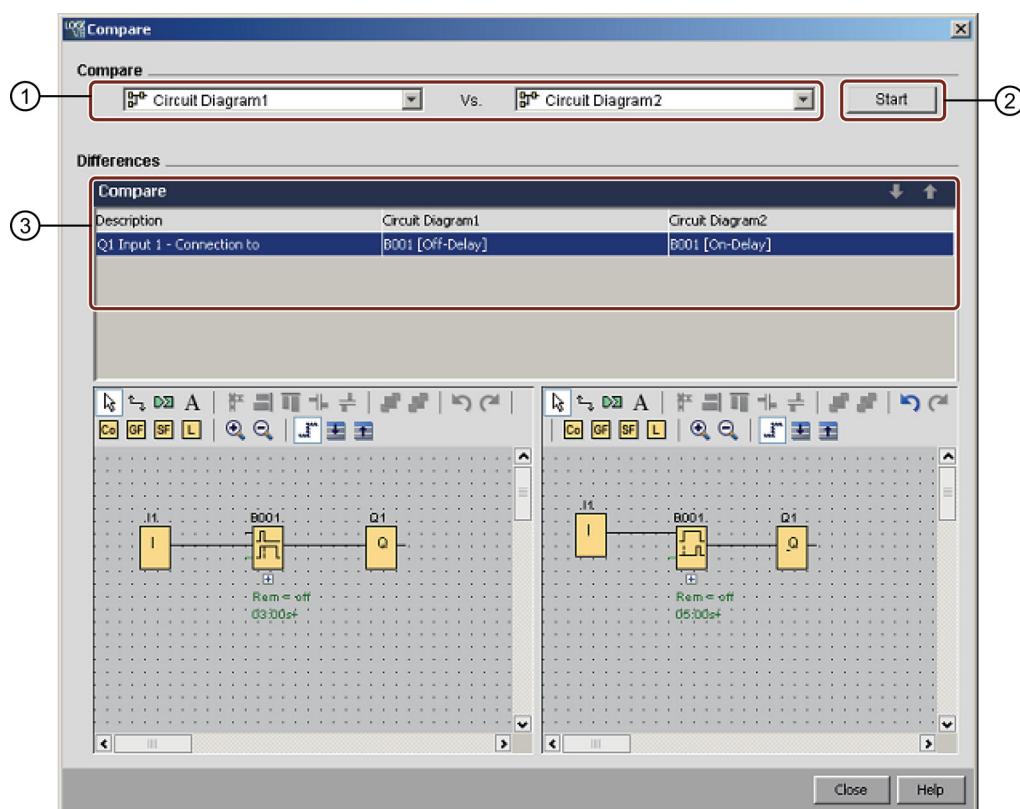

- ① Select the two circuit programs to compare.
 - To compare two local diagrams, you can split the diagram editor into two windows and drag the diagrams to each window. See Window -> Split into two windows (Page 123) for more information.
 - To compare your local diagram with the diagram on a connected LOGO! Base Module, LOGO!Soft Comfort requires that you confirm the connection interface before communication. See Tools -> Transfer (Page 70) for more information.
- ② Click "②" to run the comparison.
- ③ Here LOGO!Soft Comfort shows you the differences in the two programs:
 - Number of blocks
 - Block parameters
 - Additional/missing blocks
 - Different hardware
 - Different message text FBs (both text and bar graph)
 - Different connections
 - Different parameter VM mapping lines
 - Different Ethernet connections

Compare two circuit programs with parameter VM mapping settings

When you compare two circuit programs with parameter VM mapping settings, LOGO!Soft Comfort compares two lines and displays the comparison results. LOGO!Soft Comfort only displays the differences between the first two different lines because once two lines differ, LOGO!Soft Comfort stops comparing subsequent lines.

Configure different VM mapping settings on the two circuit programs. See Tools -> Parameter VM Mapping (0BA7 and 0BA8 only) (Page 105) for more information.

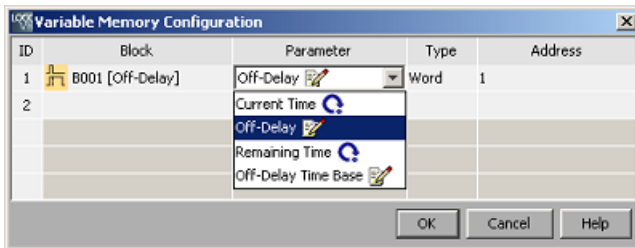
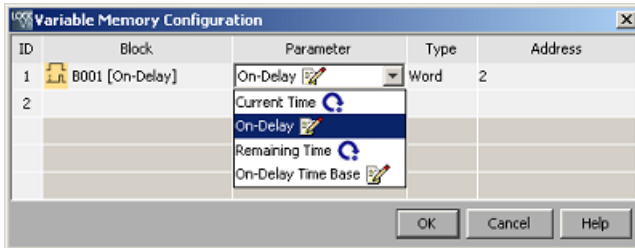

After you have set the module address and Ethernet connections, you can start to compare the two circuit programs.

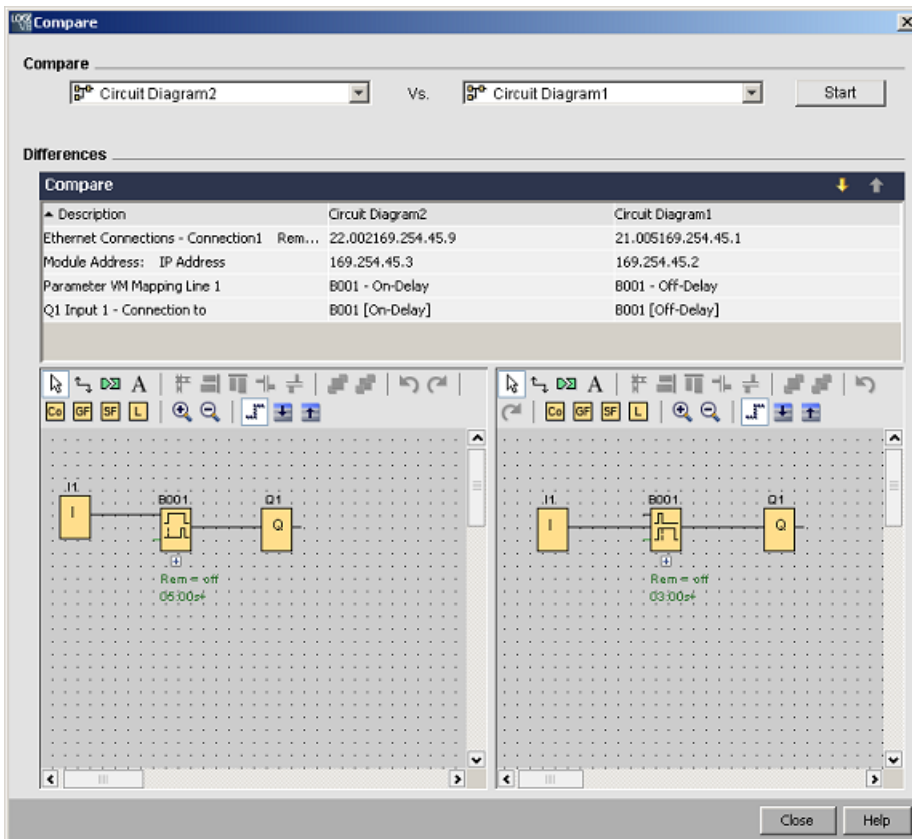

Result: As shown in the following result display, the parameter names in parameter VM mapping line 1 of the two circuit programs are different.

Compare two circuit programs with Ethernet connections

When you compare two circuit programs with Ethernet connections, LOGO!Soft Comfort compares their configurations of Ethernet connections, and then displays the comparison results.

During the comparison of Ethernet connections, once a difference occurs in a connection setting, LOGO!Soft Comfort stops comparing subsequent settings.

Set module addresses and Ethernet connections following instructions in the Tools -> Ethernet Connections (0BA7 and 0BA8 only) (Page 100) section:

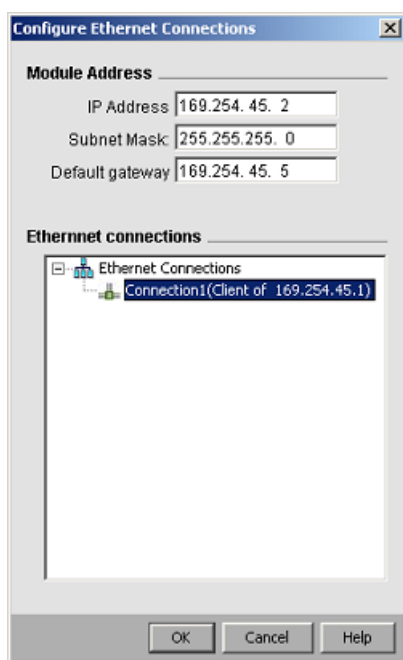
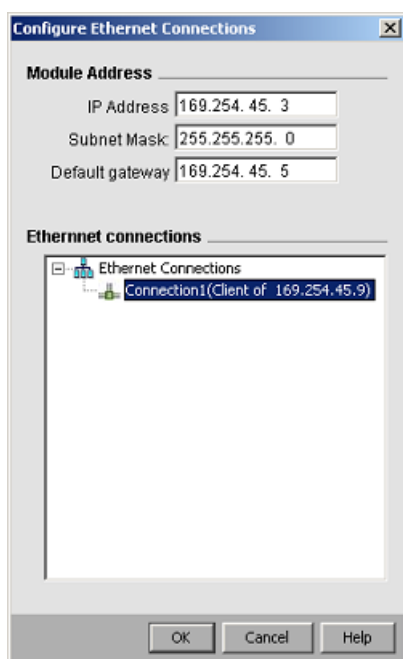

Compare the two diagrams.

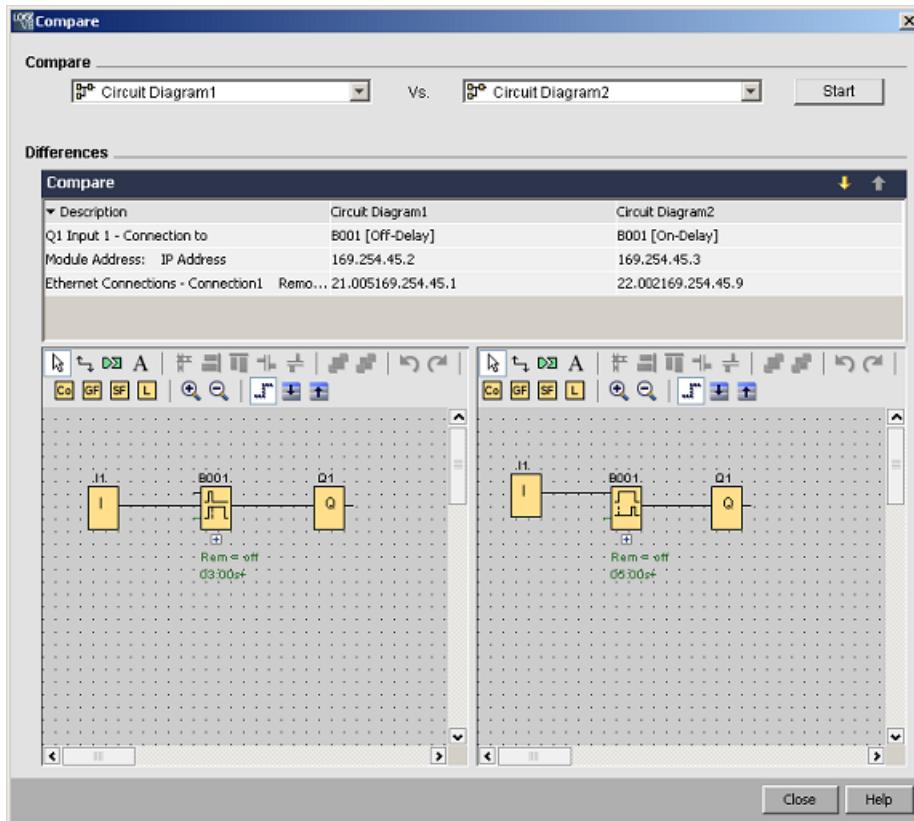

Result: As shown in the result display above, the two compared circuit programs have different module address settings and different IP address settings for two Base Modules that are both used as clients.

Editing

You can edit the two circuit programs in the diagram comparison windows.

Different hardware

If you have configured different LOGO! devices in the two programs, you will see a considerable number of messages. To avoid such messages, make sure both devices are the same.

Programs with internal markers

When you compare circuit programs with internal markers, in some circumstances LOGO!Soft Comfort reports more differences than there really are.

2.8.5.23 Tools -> Simulation



Introduction

Program simulation allows you to test a program and modify its parameters. This ensures the program in the LOGO!Soft Comfort is fully functioning and optimized, ready for your download.

Simulation mode

Click the  icon in the programming toolbar to start the simulation. This changes the program to simulation mode.

For more information, see Simulation. (Page 35)

LOGO!Soft Comfort highlights the icon simulation mode. If you have configured an IP address for your circuit program, you can click the  icon to simulate the circuit program in the network. You can watch VM (Variable Memory) values in the provided data table. To exit the simulation mode, click the  icon or any other icon of the programming toolbar. If you click another icon, you exit the simulation mode and open the tool mode of the icon that you clicked, for example selecting or inserting blocks.

At the start of the simulation mode, LOGO!Soft Comfort verifies the circuit program and displays the results in the Info Window (Page 68).

2.8.5.24 Tools -> Simulation Parameters

Select the **Tools** → **Simulation Parameters** command to configure the response of an input.

The dialog shows only the inputs actually used in your circuit program.

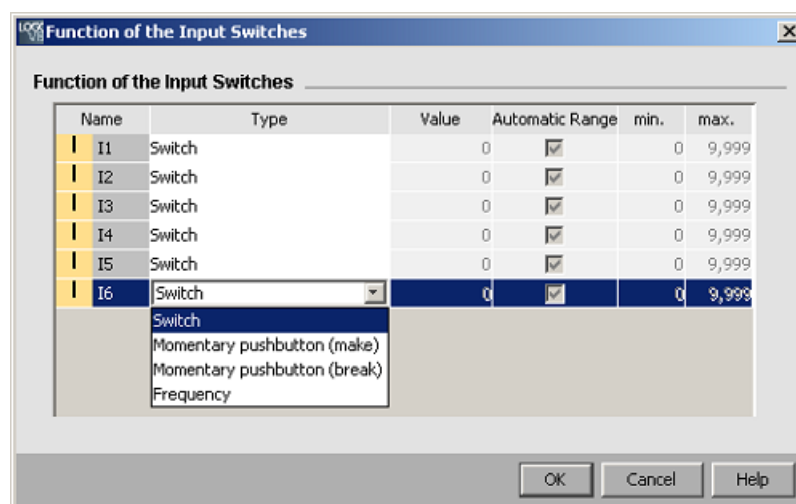

You have four options for the digital inputs:

- Switch
- Momentary pushbutton (make)

- Momentary pushbutton (break)
- Frequency

You have only one option for the analog inputs:

- Analog

Name column

"I" designates Digital inputs (Page 193).

"AI" designates Analog inputs (Page 196).

Switch

A switch latches when actuated and is released by actuating it once again.

Momentary pushbutton

A momentary pushbutton is only active while it is held down. The contact opens as soon as you release the button.

You can determine a make or break action for the pushbuttons.

Frequency

You can preset or change the frequency of an input while a simulation is running. The device frequency is in Hz. A frequency input is a special case, which is only used in conjunction with the threshold trigger SFB.

Analog

You can preset the value for the analog input (Page 196) or modify it while running in simulation mode. The units for the analog value corresponds with the default process variable. The range corresponds with the specified measurement range, provided you have selected the option of "Auto range". The value range corresponds in this case with the measurement range of the function connected to the input. The analog input represents a special case for analog SFBs.

Refer to the information in the "Analog value processing" section (Page 286) for help on analog block parameters.

Settings

When you save your circuit program, you also save the simulation settings. Thus, you do not need to enter the simulation parameters once again when you exit and reopen your circuit program.

While simulation mode is active, you can click a digital input in the list of input switches to change its settings. From the drop-down list select Switch, Momentary pushbutton (make), Momentary pushbutton (break) or Frequency. Use the OK button to enter your settings.

While simulation mode is active, you can also right-click a digital input in the circuit program and edit its block properties. In the Simulation tab of the block properties dialog, you can select the type of the input as described above.

Click "OK" to confirm your settings.

2.8.5.25 Tools -> Connect Modem

You can build network connections between LOGO!Soft Comfort and LOGO! devices to download and upload circuit programs or network projects by configuring their connected modems. LOGO!Soft Comfort supports 11-bit modems that use standard AT commands.



Select the **Tools** → **Connect Modem** menu command to start the process of configuring modems connected to your PC with LOGO!Soft Comfort. The LOGO! Base Module at the remote side is also connected with a modem and ready for network connection. LOGO!Soft Comfort displays a Modem Information dialog that provides an overview of the configuration process.

You must complete a series of dialogs to configure your modems. After you configure the modems and make the connections, you can download and upload circuit programs or network projects between LOGO!Soft Comfort and LOGO! Base Module across a telephone line connection over the modems.

The steps for connecting and configuring modems are listed below:

1. Select Modem (Page 98)
2. Select Remote Configuration (Page 98)
3. Configure Remote Modem Command (Page 98)
4. Configure Remote Modem (Page 98)
5. Select Local Configuration (Page 99)
6. Configure Local Modem Command (Page 99)
7. Configure Telephone Number (Page 99)

From the modem configuration dialogs, you can click "**Next**" to proceed through the dialogs, or click "**Previous**" to return to an earlier step.

Note

This menu command is valid only for LOGO! devices series 0BA6 or later.

2.8.5.26 Tools -> Connect Modem - Select Modem

From the Select modem dialog, you can select check boxes to configure the remote modem or the local modem. The remote modem is the one connected to the LOGO! Base Module and the local modem is the one connected to the computer with LOGO!Soft Comfort.

If you have previously configured the remote modem or the local modem from LOGO!Soft Comfort, the dialog displays the name of the modem as configured from LOGO!Soft Comfort. You can click "**Detail**" to display specific information about the LOGO!Soft Comfort configuration of a modem.

If you have configured the remote modem by some means other than LOGO!Soft Comfort, you can disregard the displayed settings. LOGO!Soft Comfort will use the configuration in the actual modem. If you have not yet configured the remote modem, or choose to change the existing configuration, then select the Remote modem check box.

For the local modem, LOGO!Soft Comfort will use the settings as displayed by the "**Detail**" button, or you can select the Local modem check box to edit the configuration.

If you need to configure or change the configuration of both modems, then select both check boxes.

If you have already configured both modems but need to set the telephone number, do not select the check boxes. When you click "**Next**", you will advance to the telephone number configuration (Page 99) dialog. Otherwise, when you click "**Next**", you will proceed to configuration of the selected modems.

2.8.5.27 Tools -> Connect Modem - Select Remote Configuration

From the Select remote configuration dialog, you select whether to edit or delete an existing configuration, if one exists, or to create a new configuration.

Click "**Next**" to continue with modem configuration.

2.8.5.28 Tools -> Connect Modem - Configure Remote Modem Command

From the Configure remote modem command dialog, you can use the name of the remote modem to access and configure a remote modem. You can select the check box to accept the default settings for the modem commands, or you can choose not to use the defaults and to edit the individual commands. The "Additional" field provides the opportunity to enter other modem commands. Separate each one with a blank if you add additional commands.

The commands are all standard commands. Refer to the documentation provided with your modem for specific command syntax.

Click "**Save Configuration**" to save this configuration for the remote modem.

2.8.5.29 Tools -> Connect Modem - Configure Remote Modem

The Configure remote modem dialog is the last dialog for you to complete remote modem configuration. After you ensure that the remote modem is connected to the LOGO! Base Module, follow these steps:

1. Select the "Done" check box.
2. Select the communications port to use.
3. Click "**Configure remote modem**".

LOGO!Soft Comfort will complete the modem configuration and display a status message.

2.8.5.30 Tools -> Connect Modem - Select Local Configuration

From the Select local configuration dialog, you select whether to edit or delete an existing configuration, if one exists, or to create a new configuration.

Click "**Next**" to continue with modem configuration.

2.8.5.31 Tools -> Connect Modem - Configure Local Modem Command

From the Configure local modem command dialog, you can use the name of the local modem to access and configure the local modem. You can select the check box to accept the default settings for the modem commands, or you can choose not to use the defaults and to edit the individual commands. The "Additional" field provides the opportunity to enter other modem commands. Separate each one with a blank if you add additional commands.

The commands are all standard commands. Refer to the documentation provided with your modem for specific command syntax.

Click "**Save Configuration**" to store this configuration to the local modem.

2.8.5.32 Tools -> Connect Modem - Configure Telephone number

From this dialog you can add and delete telephone numbers for the modem connection.

Click "**Add New**" to provide a name, telephone number, and description for a telephone connection. To add multiple telephone numbers, click "**Add New**" and enter additional telephone numbers as needed. To remove a telephone number from the list, select it and click "**Remove**".

From this dialog, you can dial one of the telephone numbers. To establish modem communication across one of the telephone connections, follow these steps:

1. Verify that the local modem is connected to your computer and that the remote modem is connected to LOGO!, and click the "**Done**" check box.
2. Select a telephone number from the list.
3. Click "**Dial**".

LOGO!Soft Comfort establishes the modem connection and displays a status message. If any error occurs, LOGO!Soft Comfort displays an error message. Check your connections and your configurations if you receive an error. Refer to the documentation provided with your modem for additional information.

2.8.5.33 Tools -> Disconnect Modem

Use this command to disconnect an existing modem connection.

To configure modems, or to re-connect across configured modems, select the Tools → Connect Modem (Page 97) menu command.

2.8.5.34 Tools -> Ethernet Connections (0BA7 and 0BA8 only)

Use this menu command to configure the module address and build Ethernet connections for the LOGO! Base Module.

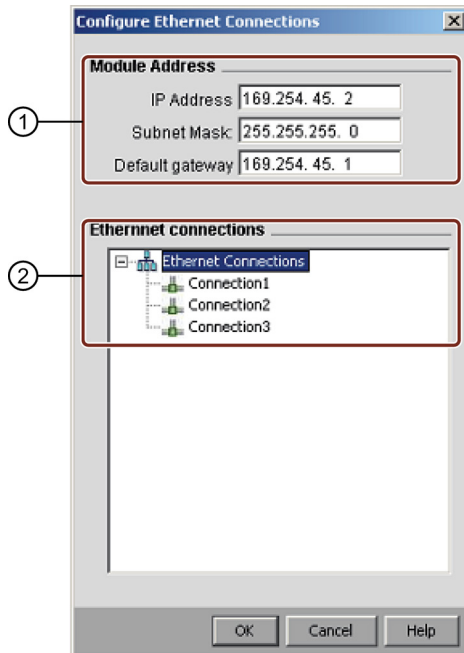

- ① Here you define the IP address of the LOGO! Base Module.
You first configure the IP address, subnet mask and gateway of the LOGO! Base Module before making the Ethernet connections.
- ② Here you define the Ethernet properties connected.
To add a client/server connection, you can right click a connection item to enable the buttons:

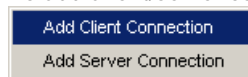

A LOGO! Base Module can support a maximum of eight network connections, which are TCP/IP-based S7 communication connections to the following devices:

- Additional LOGO! devices
- SIMATIC S7 PLCs with Ethernet capability
- A maximum of one SIMATIC HMI (Operator Panel) that supports Ethernet communication with networked S7 PLCs

Note

For detailed information about S7 communication configurations between the LOGO! Base Module, SIMATIC PLCs and HMIs, see FAQs under the Support selection at LOGO! Website (<http://www.siemens.com/logo>).

Each S7 connection can be configured to be a client or a server, in which the local IP/local TSAP (Transmission Layer Service Access Point) and remote IP/remote TSAP are configured respectively. The server is the data source side in communication, it sends information that responds to the requests from the other side - the client.

To configure the client or server connections of each LOGO! connection, double-click the connection.

Configuring client connections

Right click the desired connection and choose to add a client connection.

Double-click the connection item to configure the client connection.

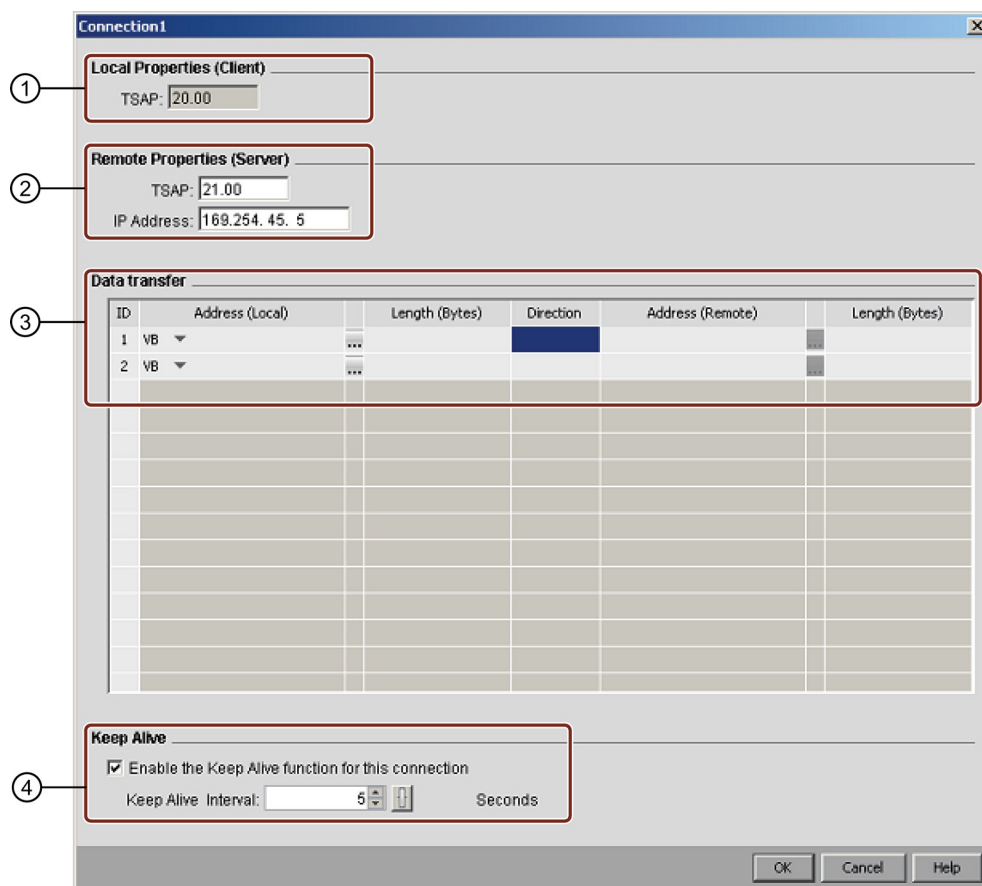

- ① Here you define the properties of the Client.
TSAP is the Transmission Layer Service Access Point in TCP/IP communication.
The local TSAP of Client is automatically generated by LOGO!Soft Comfort.
- ② Here you define the properties of the Server.
The remote TSAP is the TSAP of the Server that you want to connect.
The remote IP address is the IP address of the Server that you want to connect.
- ③ Here you define the properties of the data transfer connection. (Read:Client <- Server, Write: Client -> Server)
You can create a maximum of 32 data transfers in a Client connection.
In the read process, the local Base Module reads data from the remote server and stores it; in the write process, the local Base Module writes data to the remote server. You can store data either on the local Base Module or the remote Server by specifying the corresponding column. The maximum transfer data length is 212 bytes for every data transfer.
- ④ Here you define the time interval that LOGO! Base Module checks the connection.
You can select the check box and input the specified time interval.

Data transfer configuration

You can set the following values in the data transfer table in configuring client connections:

1. Click the following drop-down menu to choose the data value for transferring.



2. Input one address in the address field.
3. If you configured VM mapping, you can also click  to display the VM mapping table as below:

Address	Mapping
VB0	
VB1	
VB2	
VB3	
VB4	
VB5	
VB6	
VB7	
VB8	
VR0	

VM mapping table  

In the VM mapping table, you can perform the following operations:

- Click a column to choose the desired address or click and drag down and up to choose multiple addresses.
- Click the mapping fields to switch to the parameter VM mapping dialog.
- Click and drag the black arrow at the bottom right corner to expand or shrink the table.

See Tools -> Parameter VM Mapping (0BA7 and 0BA8 only) (Page 105) for more information about the VM mapping.

4. Click the empty drop-down menu to choose data transfer directions.



5. Input the other address.
6. To add or remove rows, right-click an existing row to enable the buttons.

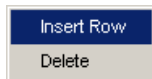

7. Save your changes.

Configuring server connections

Double-click the connection item to configure the server connection.

Note

If the Server in this connection is a SIMATIC S7 or SIMATIC HMI, you must configure the server connection on the added device.

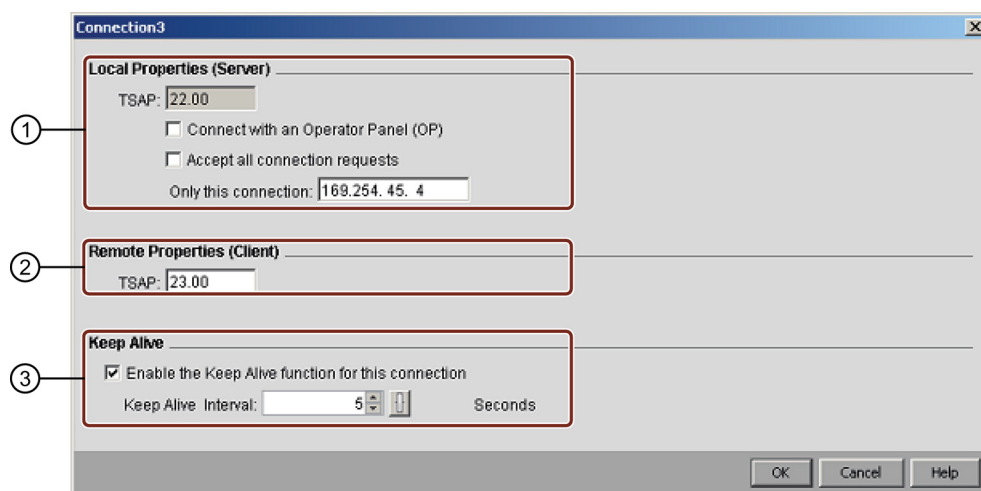

- ① Here you define the properties of the Server.
TSAP: The range in LOGO! Base Module is 20.00 to FF.FF.
The local TSAP of Server is automatically generated by LOGO!Soft Comfort. If the Operator Panel (SIMATIC HMI) is the Client in this connection, select the "Connect with an Operator Panel (OP)" check box. LOGO!Soft Comfort then automatically changes the TSAP to 02.00.
If you select the "Accept all connections requests" check box, the Server responds to the requests from all Clients in the network.
The Server can accept a request only from one IP address. This address is the IP address of the client that you want to connect.
- ② Here you define the properties of the Client.
The remote TSAP is the TSAP of the Client that you want to connect.
- ③ Here you define the time interval that LOGO! Base Module checks the connection.
You can select the check box and input the specified time interval.

Data transfer restrictions

The table below describes the range and local address restrictions for client connections.

Read requests:

Local address		Remote address	
Address Type	Range	Address Type	Range
VB	0 to 850	VB	0 to 65535
		DB.DBB	DB[0 to 16000].DBB[0 to 65535]
		MB	0 to 65535
		IB	0 to 65535
		QB	0 to 65535

Note

Address Type:

- VB: variable byte memory
- DB.DBB: data block byte memory
- MB: flag byte memory
- IB: input byte memory
- QB: output byte memory

$$\text{Local address} + \text{Data length} - 1 \leq 850$$

The table below describes the range and local address restrictions of client connection.

Write requests:

Local address		Remote address	
Address Type	Range	Address Type	Range
VB	0 to 850	VB	0 to 65535
MB	0 to 3	DB.DBB	DB[0,16000].DBB[0,65535]
IB	0 to 2	MB	0 to 65535
QB	0 to 1	IB	0 to 65535
		QB	0 to 65535

Note

The values should follow the rule: $\text{Local address} + \text{Data length} - 1 \leq \text{Max value of Local address type}$.

2.8.5.35 Tools -> Parameter VM Mapping (0BA7 and 0BA8 only)

VM overview

LOGO! Base Module uses VM (Variable Memory) as a local S7 communication interface for data exchange by means of connections/data-transfer configuration.

You can use LOGO!Soft Comfort with the Ethernet connections menu command following instructions in the Tools -> Ethernet Connections (0BA7 and 0BA8 only) (Page 100) section to construct the network topology.

LOGO!Soft Comfort performs data exchange process as follows:

- The server stores the required data into the VM area specified by the S7 connection and data transfer. This is defined as a "share" action in the following section.
- The client unit reads the server's VM area and then updates the corresponding local VM area in its network process step.
- After the local update, the circuit program in the client can use the information in the local VM originated from the Server.

Data type and VM address

The following illustrates VM addressing and data type usage:

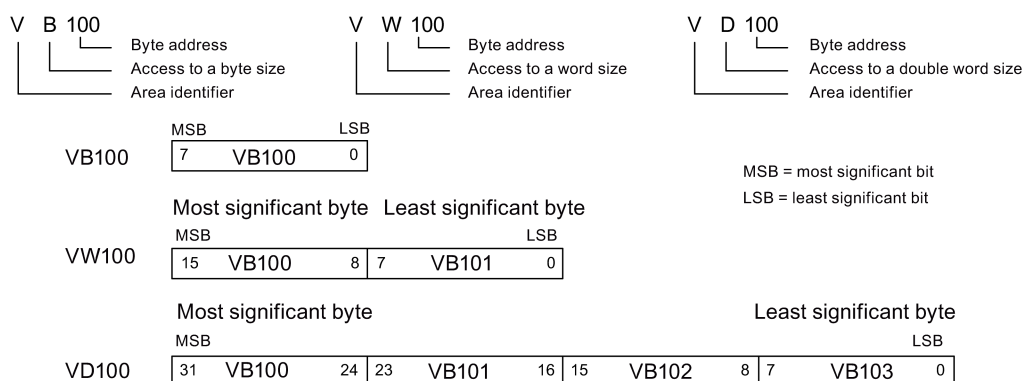

Creating a parameter VM mapping

When you change a parameter value in the local VM, the value in LOGO!Soft Comfort changes accordingly. In this way, LOGO!Soft Comfort synchronizes information with the local VM in real time.

LOGO!Soft Comfort synchronizes the parameter values of a block to the specified VM in each LOGO! cycle. After the synchronization, LOGO! Base Module can use the VM to communicate with other SIMATIC devices. You can map up to 64 parameters in VM for each LOGO! Base Module in the Variable Memory Configuration dialog. The following screen is an example of the configuration dialog of parameter VM mapping:

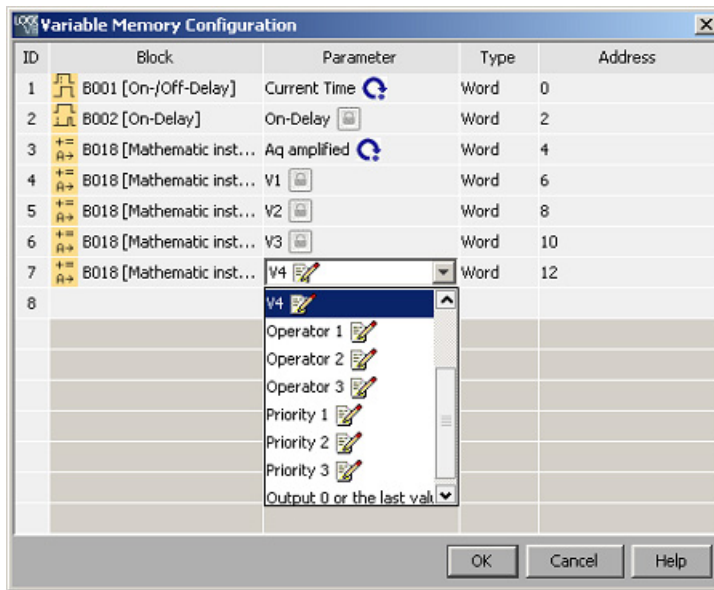

The Block column lists the parameters for SFBs in the current program. The Parameter column provides a select list of the parameters of the corresponding block. The Type column displays the data type of the selected parameter. The Address column is also configurable. You can use it to identify the VM address used to save a parameter value.

The icon next to a parameter name indicates the property of this parameter:



The parameter value is a setting value and is writable.



The parameter value is an actual value and is read-only.



Although the parameter value is an actual value, you can still change the value.

NOTE:

Only the **Counter** parameter of Up/Down counter has such a flag.



The parameter value is referenced from an actual value of another already-programmed function block.

Note that if no flag appears, then the parameter value is a system value and remains read-only.

Within the parameter VM mapping window, you can achieve the following tasks:

- Select multiple record lines by pressing the **Ctrl** key or **Shift** key and clicking the ID of the desired line.
- Insert a down line by pressing the **Enter** key on the last cell of the desired line.
- Insert an up line by clicking the ID of the desired line and pressing the **Insert** key, or right-clicking the desired line to add a new row.
- Delete a line by clicking the ID of the desired line and pressing the **Delete** key, or right-clicking the desired line to delete an existing row.

You cannot change the parameter type and must configure a unique address for each parameter. The range for a parameter address is from 0 to 850. If the value you input exceeds this range, inputs and outputs will be modified to certain VM addresses automatically.

The following table provides mappings between I/O and VM addresses for LOGO! 0BA8:

Block Type	VM Address (From)	VM Address (To)	Range
I	1024	1031	8 bytes
AI	1032	1063	32 bytes
Q	1064	1071	8 bytes
AQ	1072	1103	32 bytes
M	1104	1117	14 bytes
AM	1118	1245	128 bytes
NI	1246	1261	16 bytes
NAI	1262	1389	128 bytes
NQ	1390	1405	16 bytes
NAQ	1406	1469	64 bytes

The following table provides mappings between I/O and VM addresses for LOGO! 0BA7:

DI	VM Address	DQ	VM Address
I1	V923.0	Q1	V942.0
I2	V923.1	Q2	V942.1
I3	V923.2	Q3	V942.2
I4	V923.3	Q4	V942.3
I5	V923.4	Q5	V942.4
I6	V923.5	Q6	V942.5
I7	V923.6	Q7	V942.6
I8	V923.7	Q8	V942.7
I9	V924.0	Q9	V943.0
I10	V924.1	Q10	V943.1
I11	V924.2	Q11	V943.2
I12	V924.3	Q12	V943.3
I13	V924.4	Q13	V943.4
I14	V924.5	Q14	V943.5
I15	V924.6	Q15	V943.6
I16	V924.7	Q16	V943.7
I17	V925.0		
I18	V925.1		
I19	V925.2		
I20	V925.3		
I21	V925.4		
I22	V925.5		
I23	V925.6		
I24	V925.7		

AI	VM Address	AQ	VM Address
AI1	VW926	AQ1	VW944
AI2	VW928	AQ2	VW946
AI3	VW930		
AI4	VW932		
AI5	VW934		
AI6	VW936		
AI7	VW938		
AI8	VW940		
AM	VM Address	M	VM Address
AM1	VW952	M1	V948.0
AM2	VW954	M2	V948.1
AM3	VW956	M3	V948.2
AM4	VW958	M4	V948.3
AM5	VW960	M5	V948.4
AM6	VW962	M6	V948.5
AM7	VW964	M7	V948.6
AM8	VW966	M8	V948.7
AM9	VW968	M9	V949.0
AM10	VW970	M10	V949.1
AM11	VW972	M11	V949.2
AM12	VW974	M12	V949.3
AM13	VW976	M13	V949.4
AM14	VW978	M14	V949.5
AM15	VW980	M15	V949.6
AM16	VW982	M16	V949.7
		M17	V950.0
		M18	V950.1
		M19	V950.2
		M20	V950.3
		M21	V950.4
		M22	V950.5
		M23	V950.6
		M24	V950.7
		M25	V951.0
		M26	V951.1
		M27	V951.2

The following VM addresses are occupied for special purposes:

VM Address	Reserved for	Range
984	Diagnostic Bits Array	1 Byte
985	"Year" of Real Time Clock (RTC)	1 Byte
986	"Month" of RTC	1 Byte
987	"Day" of RTC	1 Byte
988	"Hour" of RTC	1 Byte
989	"Minute" of RTC	1 Byte
990	"Second" of RTC	1 Byte

The LOGO! Base Module can share the following data with S7 by VM address:

Data Type	Number	Memory Type
Digital input	24	Byte
Digital output	16	Byte
Digital flag	27	Byte
Analog input	8	Word
Analog output	2	Word
Analog flag	16	Word
Value parameter	**	**
Actual value	**	**

The length (Byte, Word, or DWord) indicates the number of bytes in the VM area required by the parameter.

LOGO! Base Module can also share the time and date information with SIEMENS SIMATIC S7 compatible devices and HMI devices using VM addresses from 991 to 1002.

LOGO!Soft Comfort links the block parameters that you specify in the Variable Memory Configuration dialog with a VM address.

Not all of the VM area is available for configuration. LOGO!Soft Comfort reserves some bytes of the VM area. You cannot specify more than 64 parameters. If you attempt to specify more than 64, LOGO!Soft Comfort displays a failed operation message.

After the data transfer from a LOGO! Base Module to LOGO!Soft Comfort, you can view only analog values within the range of -32768 to 32767 on LOGO!Soft Comfort. If an analog value exceeds the value range, then only the nearest upper limit (32767) or lower limit (-32768) can be displayed.

Parameter settings

Function Block	Data type	Read/Write	Parameter settings in LOGO!Soft Comfort	Parameter settings on a partner device
On-Delay				
Current Time	VW	R		
On-Delay	VW	R/W	Unit: Seconds	Value range: 0 to 9999
			Unit: Minutes or Hours	Value range: 0 to 5999

Function Block	Data type	Read/Write	Parameter settings in LOGO!Soft Comfort	Parameter settings on a partner device
Remaining Time	VW	R		
On-Delay Time Base	VB	R/W	10 milliseconds	1
			Seconds	2
			Minutes	3
Off-Delay				
Current Time	VW	R		
On-Delay	VW	R/W	Unit: Seconds	Value range: 0 to 9999
			Unit: Minutes or Hours	Value range: 0 to 5999
Remaining Time	VW	R		
On-Delay Time Base	VB	R/W	10 milliseconds	1
			Seconds	2
			Minutes	3
On-/Off-Delay				
Current Time	VW	R		
On Time (TH)	VW	R/W	Unit: Seconds	Value range: 0 to 9999
			Unit: Minutes or Hours	Value range: 0 to 5999
Off Time (TL)	VW	R/W	Unit: Seconds	Value range: 0 to 9999
			Unit: Minutes or Hours	Value range: 0 to 5999
On Time (TH) Remaining Time	VW	R		
Off Time (TL) Remaining Time	VW	R		
On Time (TH) Time Base	VB	R/W	10 milliseconds	1
			Seconds	2
			Minutes	3
Off Time (TL) Time Base	VB	R/W	10 milliseconds	1
			Seconds	2
			Minutes	3
Current Time Base	VB	R/W	10 milliseconds	1
			Seconds	2
			Minutes	3
Retentive On-Delay				
Current Time	VW	R		
On-Delay	VW	R/W	Unit: Seconds	Value range: 0 to 9999
			Unit: Minutes or Hours	Value range: 0 to 5999
Remaining Time	VW	R		
On-Delay Time Base	VB	R/W	10 milliseconds	1
			Seconds	2
			Minutes	3
Wiping Relay (Pulse Output)				
Current Time	VW	R		
Off Time (TL)	VW	R/W	Unit: Seconds	Value range: 0 to 9999

Function Block	Data type	Read/Write	Parameter settings in LOGO!Soft Comfort	Parameter settings on a partner device
			Unit: Minutes or Hours	Value range: 0 to 5999
Off Time (TL) Remaining Time	VW	R		
Off Time (TL) time Base	VB	R/W	10 milliseconds	1
			Seconds	2
			Minutes	3
Edge Triggered Wiping Relay				
Current Time	VW	R		
Pulse Width (TH)	VW	R/W	Unit: Seconds	Value range: 0 to 9999
			Unit: Minutes or Hours	Value range: 0 to 5999
Interpulse Width (TL)	VW	R/W	Unit: Seconds	Value range: 0 to 9999
			Unit: Minutes or Hours	Value range: 0 to 5999
Pulse Width (TH) Remaining Time	VW	R		
Interpulse Width (TL) Remaining Time	VW	R		
Pulse Width (TH) Time Base	VB	R/W	10 milliseconds	1
			Seconds	2
			Minutes	3
Interpulse Width (TL) Time Base	VB	R/W	10 milliseconds	1
			Seconds	2
			Minutes	3
Current Time Base	VB	R	10 milliseconds	1
			Seconds	2
			Minutes	3
Asynchronous Pulse Generator				
Current Time	VW	R		
Pulse Width	VW	R/W	Unit: Seconds	Value range: 0 to 9999
			Unit: Minutes or Hours	Value range: 0 to 5999
Interpulse Width	VW	R/W	Unit: Seconds	Value range: 0 to 9999
			Unit: Minutes or Hours	Value range: 0 to 5999
Pulse Remaining Time	VW	R		
Interpulse Remaining Time	VW	R		
Pulse Width (TH) Time Base	VB	R/W	10 milliseconds	1
			Seconds	2
			Minutes	3
Interpulse Width (TL) Time Base	VB	R/W	10 milliseconds	1
			Seconds	2
			Minutes	3
Current Time Base	VB	R	10 milliseconds	1
			Seconds	2
			Minutes	3

Function Block	Data type	Read/Write	Parameter settings in LOGO!Soft Comfort	Parameter settings on a partner device
Random Generator				
Current Time	VW	R		
Max. On Delay (TH)	VW	R/W	Unit: Seconds	Value range: 0 to 9999
			Unit: Minutes or Hours	Value range: 0 to 5999
Max. Off Delay (TL)	VW	R/W	Unit: Seconds	Value range: 0 to 9999
			Unit: Minutes or Hours	Value range: 0 to 5999
Max. On Delay (TH) Remaining Time	VW	R		
Max. Off Delay (TL) Remaining Time	VW	R		
Max. On Delay (TH) Time Base	VB	R/W	10 milliseconds	1
			Seconds	2
			Minutes	3
Max. Off Delay (TL) Time Base	VB	R/W	10 milliseconds	1
			Seconds	2
			Minutes	3
Current Time Base	VB	R	10 milliseconds	1
			Seconds	2
			Minutes	3
Stairway Lighting Switch				
Current Time	VW	R		
Off Delay	VW	R/W	Unit: Seconds	Value range: 0 to 9999
			Unit: Minutes or Hours	Value range: 0 to 5999
Pre-Warning Time (T!)	VW	R		
Pre-Warning Period (T!L)	VW	R		
Off Delay Remaining	VW	R		
Pre-Warning Time (T!) Remaining	VW	R		
Pre-Warning Period (T!L) Remaining	VW	R		
Off Delay Time Base	VB	R/W	10 milliseconds	1
			Seconds	2
			Minutes	3
Multiple Function Switch				
Current Time	VW	R		
Off Delay Time (T)	VW	R/W	Unit: Seconds	Value range: 0 to 9999
			Unit: Minutes or Hours	Value range: 0 to 5999
Permanent Light (TL)	VW	R/W	Unit: Seconds	Value range: 0 to 9999
			Unit: Minutes or Hours	Value range: 0 to 5999
Pre-Warning Time (T!)	VW	R		
Pre-Warning Period (T!L)	VW	R		

Function Block	Data type	Read/Write	Parameter settings in LOGO!Soft Comfort	Parameter settings on a partner device
Off Delay Time (T) Remaining	VW	R		
Permanent Light (TL) Remaining	VW	R		
Pre-Warning Time (T!) Remaining	VW	R		
Pre-Warning Period (T!L) Remaining	VW	R		
Off Delay Time (T) Time Base	VB	R/W	10 milliseconds	1
			Seconds	2
			Minutes	3
Permanent Light (TL) Time Base	VB	R/W	10 milliseconds	1
			Seconds	2
			Minutes	3
Current Time Base	VB	R	10 milliseconds	1
			Seconds	2
			Minutes	3
Weekly Timer (When an entry box is set unavailable or a function is disabled, "0xFF" is displayed on an HMI or S7 PLC and "*" is displayed on a Base Module.)				
Week Day 1	VB	R/W	Sunday	Bit 0
			Monday	Bit 1
			Tuesday	Bit 2
			Wednesday	Bit 3
			Thursday	Bit 4
			Friday	Bit 5
			Saturday	Bit 6
				NOTE: If the related bit is 1, then the day is set.
On Time 1	VW	R/W	h:m	h:m
Off Time 1	VW	R/W	h:m	h:m
Week Day 2	VB	R/W	Sunday	Bit 0
			Monday	Bit 1
			Tuesday	Bit 2
			Wednesday	Bit 3
			Thursday	Bit 4
			Friday	Bit 5
			Saturday	Bit 6
				NOTE: If the related bit is 1, then the day is set.
On Time 2	VW	R/W	h:m	h:m
Off Time 2	VW	R/W	h:m	h:m

Function Block	Data type	Read/Write	Parameter settings in LOGO!Soft Comfort	Parameter settings on a partner device
Week Day 3	VB	R/W	Sunday	Bit 0
			Monday	Bit 1
			Tuesday	Bit 2
			Wednesday	Bit 3
			Thursday	Bit 4
			Friday	Bit 5
			Saturday	Bit 6
				NOTE: If the related bit is 1, then the day is set.
On Time 3	VW	R/W	h:m	h:m
Off Time 3	VW	R/W	h:m	h:m
Pulsely	VB	R/W	Off	0
			On	1
Yearly Timer (When an entry box is set unavailable, "0xFF" is displayed on an HMI or S7 PLC and "-" is displayed on a Base Module.)				
On Time	VW	R/W	Month:Day	Month:Day
Off Time	VW	R/W	Month:Day	Month:Day
On Year	VB	R/W	Year	Year
Off Year	VB	R/W	Year	Year
Monthly	VB	R/W	No	0
			Yes	1
Yearly	VB	R/W	No	0
			Yes	1
Pulsely	VB	R/W	Off	0
			On	1
Astronomical Clock				
Longitude	VD	R/W		VBx+0
			W	1
			E	0
			°	VBx+1
			'	VBx+2
			"	VBx+3
Latitude	VD	R/W		VBx+0
			S	1
			N	0
			°	VBx+1
			'	VBx+2
			"	VBx+3

Function Block	Data type	Read/Write	Parameter settings in LOGO!Soft Comfort	Parameter settings on a partner device
Time Zero (E+; W-)	VW	R/W		-11 to 12 Low byte bit 7 means sign, for example: 00000001 10000000 means -1.
SunRise Time	VW	R		h:m
SunSet Time	VW	R		h:m
Stop Watch				
Time Base	VB	R/W	10 milliseconds	0
			Seconds	1
			Minutes	2
			Hours	3
Current Time	VD	R		
Lap Time	VD	R		
Output Time	VW	R		
Up/Down Counter				
Counter	VD	R/W		0 to 999999
On Threshold	VD	R/W		0 to 999999
Off Threshold	VD	R/W		0 to 999999
start value	VD	R/W		0 to 999999
Hours Counter				
Maintenance Interval (MI)	VD	R/W		0 to 599999 (9999H 59M)
Time-to-Go (MN)	VD	R		
Total Time (OT)	VD	R		
Threshold Trigger				
Frequency	VW	R		
On Threshold	VW	R/W		0 to 9999
Off Threshold	VW	R/W		0 to 9999
Gate Time	VW	R		
Analog Threshold Trigger				
On	VW	R/W		-20000 to 20000
Off	VW	R/W		-20000 to 20000
Gain	VW	R		
Offset	VW	R		
Ax, Amplified	VW	R		
Analog Differential Trigger				
On	VW	R/W		-20000 to 20000
Differential	VW	R/W		-20000 to 20000
Gain	VW	R		
Offset	VW	R		
Ax, Amplified	VW	R		
Off	VW	R		

Function Block	Data type	Read/Write	Parameter settings in LOGO!Soft Comfort	Parameter settings on a partner device
Analog Comparator				
On	VW	R/W		-20000 to 20000
Off	VW	R/W		-20000 to 20000
Gain	VW	R		
Offset	VW	R		
Ax, Amplified	VW	R		
Ay, Amplified	VW	R		
Ax (Amplified)-Ay (Amplified)	VW	R		
Analog Watchdog				
Gain	VW	R		
Offset	VW	R		
Aen (Comparison Value)	VW	R		
Ax, Amplified	VW	R		
Differential (+)	VW	R/W		0 to 20000
Differential (-)	VW	R/W		0 to 20000
Analog Amplifier				
Analog Amplifier: Gain	VW	R		-1000 to 1000
Analog Amplifier: Offset	VW	R		-10000 to 10000
Analog Amplifier: Ax, Amplified	VW	R		
Analog Multiplexer				
AQ Amplified	VW	R		
V1 (S1=0; S2=0)	VW	R/W		-32768 to 32767
V2 (S1=0; S2=1)	VW	R/W		-32768 to 32767
V3 (S1=1; S2=0)	VW	R/W		-32768 to 32767
V4 (S1=1; S2=1)	VW	R/W		-32768 to 32767
PWM				
Min.	VW	R/W		-10000 to 20000
Max.	VW	R/W		-10000 to 20000
Gain	VW	R		-1000 to 1000
Offset	VW	R		-10000 to 10000
Ax, Amplified (Current Period)	VW	R		
T	VW	R/W	Unit: Seconds	Value range: 0 to 9999
			Unit: Minutes or Hours	Value range: 0 to 5999
Periodic Time Time Base	VB	R/W	10 milliseconds	1
			Seconds	2
			Minutes	3
Mathematic Instructions				
AQ Amplified	VW	R		
V1	VW	R/W		-32768 to 32767

Function Block	Data type	Read/Write	Parameter settings in LOGO!Soft Comfort	Parameter settings on a partner device
V2	VW	R/W		-32768 to 32767
V3	VW	R/W		-32768 to 32767
V4	VW	R/W		-32768 to 32767
Operator 1	VB	R/W		VBx+0
			+	0
			-	1
			*	2
			/	3
Operator 2	VB	R/W		VBx+0
			+	0
			+	1
			*	2
			/	3
Operator 3	VB	R/W		VBx+0
			+	0
			-	1
			*	2
			/	3
Priority1	VB	R/W	L	0
			M	1
			H	2
Priority2	VB	R/W	L	0
			M	1
			H	2
Priority3	VB	R/W	L	0
			M	1
			H	2
Reset Mode	VB	R/W	Reset to zero	0
			Keep last value	1
Analog Ramp				
Gain	VW	R		
Offset	VW	R		
Current Level	VW	R		
Level 1 (L1)	VW	R/W		-10000 to 20000
Level 2 (L2)	VW	R/W		-10000 to 20000
Largest Output Value	VW	R		
Start/Stop Offset	VW	R/W		0 to 20000
Speed of Change	VW	R/W		1 to 10000
PI Controller				
Set Value (SP)	VW	R/W		-10000 to 20000
PV, Amplified	VW	R		

Function Block	Data type	Read/Write	Parameter settings in LOGO!Soft Comfort	Parameter settings on a partner device
Aq	VW	R		
Kc	VW	R/W		0 to 9999
Integration Time (TI)	VW	R/W	Unit: Minutes	0 to 5999
Direction	VB	R/W	+	0
			-	1
Manual Output (Mq)	VW	R/W		0 to 1000
min	VW	R/W		-10000 to 20000
max	VW	R/W		-10000 to 20000
Gain	VW	R		-1000 to 1000
Offset	VW	R		-10000 to 10000
Analog Filter				
Dialog Parameter Average Value Sample Number	VB	R/W		3 to 8
			8	3
			16	4
			32	5
			64	6
			128	7
			256	8
Ax	VW	R		
Aq	VW	R		
Max/Min				
Mode	VB	R/W		0, 1, 2 and other value
Ax	VW	R		
Minimum Value	VW	R		
Maximum Value	VW	R		
Aq	VW	R		
When reset=0, reset Min/Max	VB	R/W		0 or 1
Average Value				
Sample Time	VW	R/W	Unit: Seconds or Minutes	Value range: 0 to 59
			Unit: Hours	Value range: 0 to 23
			Unit: Days	Value range: 0 to 365
Number of Samples	VW	R/W	Unit: Seconds	Value range: 1 to St*100
			Unit: Days	Value range: 1 to 32767
			Unit: Hours	Value range: 1 to 32767
			Unit: Seconds and ≤ 5 Minutes	Value range: 1 to St*6000
			Unit: Seconds and ≥ 6 Minutes	Value range: 1 to 32767
Ax	VW	R		

Function Block	Data type	Read/Write	Parameter settings in LOGO!Soft Comfort	Parameter settings on a partner device
Aq	VW	R		
Sample Time Time Base	VB	R/W	Seconds	1
			Minutes	2
			Hours	3
			Days	4

2.8.5.36 Tools -> Options

Here you can select various options for LOGO!Soft Comfort:

- General (Page 119)
- Preference (Page 120)
- Print (Page 120)
- Cut connections (Page 121)
- Simulation (Page 121)
- Colors (Page 122)
- UDF (Page 122)
- CSV Separator (Page 122)

2.8.5.37 Tools -> Options: General

Here you can define your default editor.

- Edit your circuit diagram always in the FBD Diagram Editor
- Edit your circuit diagram always in the LAD Editor

Here you can also define the user interface language.

- Display the user interface in Deutsch
- Display the user interface in English
- Display the user interface in Spain
- Display the user interface in French
- Display the user interface in Italian
- Display the user interface in Chinese

To set and apply a new language, you must close and restart LOGO!Soft Comfort.

Note

Change your operating system language prior to changing the language for LOGO!Soft Comfort.

2.8.5.38 Tools -> Options: Preference

Here you can define your preferred display settings.

- Whether to display comments
- Whether to display connector names
- Whether to display parameters of a block
- Whether to use antialiasing in the drawing
- Whether to label marked lines
- Whether to save the software interface and working environment
- Whether to start from the diagram tab or project tab

Other possible settings:

- Antialiasing: With antialiasing, corners and edges appear softened.
- If you enable View > Select lines (Page 68) with **Label marked lines**, the marked lines are labeled as the following example:



B007 > B006/2 means that the connection runs from block 7 to block 6 at input(pin) 2. LOGO!Soft Comfort does not label connections if the target block to which the connection is running is in the immediate vicinity.

2.8.5.39 Tools -> Options: Print

Here you can determine the appearance of your printed circuit programs:

- Whether to print the comment you have entered in the comment tab under File → Properties: General (Page 54)
- Whether to print the Ethernet connections you have configured under Tools -> Ethernet Connections (0BA7 and 0BA8 only) (Page 100)
- Whether to print the parameter VM mapping you have configured under Tools -> Parameter VM Mapping (0BA7 and 0BA8 only) (Page 105)
- Whether to print the connector names and parameters in a circuit diagram
- Whether to print the list of the parameters of all blocks, of all selected blocks, or only of the special timer functions
- Whether to print the list of connector names
- Whether to suppress empty page
- Inputting the desired zoom factors for the printing

2.8.5.40 Tools -> Options: Cut Connections

Here you can choose to cut connections via the Cut/Join (Page 39) either manually or automatically.

You can specify one or both of the following types of connections to be cut:

- Connections on import or on upload
- Connections routed across a block
- Connections exceeding a configurable length

In the radius text box you can choose either to input the radius points directly or to use the scroll bar.



After confirming these settings, LOGO!Soft Comfort will cut connections accordingly.

If you configured LOGO!Soft Comfort to cut connections during importing or uploading, the software cuts connections according in the following cases:

- When you upload (transfer) a circuit program from LOGO! to LOGO!Soft Comfort
- When you import (open) a circuit program created with LOGO!Soft Standard or LOGO!Soft Comfort

2.8.5.41 Tools -> Options: Simulation

Here you can configure the simulation parameters and its displayed status:

- For starting a simulation:
 - You can choose whether to start the simulation automatically when you switch to simulation mode. Otherwise, you must press the green arrow icon  to start simulation from simulation mode.
 - You can choose whether to automatically simulate network communication when the IP address is accessible. Otherwise, you must press the icon  to start simulation in network.
 - You can specify whether to reset the status of inputs and outputs at the start of simulation.
- For interface display:
 - You can also specify whether to switch the display of signal states and process variables on or off in simulation mode. Switching it off improves the performance of your simulation because when you disable the display of signal states and process variables, there is no need for LOGO!Soft Comfort to calculate these values continuously.
 - In addition, you can specify whether to display a separate simulation window for text messages on the LOGO! TD/LOGO! TDE. If selected, simulation mode shows active message texts for the LOGO! Base Module and the LOGO! TD/LOGO! TDE in separate windows.
 - You can specify whether to show the elapsed time for simulation in standard 12 hour format.

2.8.5.42 Tools -> Options: Colors

Here you can define the following elements of the color settings:

- Desktop color
- Colors of signal lines carrying a logical "1" or "0" signal in simulation mode
- Color setting for UDF block frame in circuit program
- Colors for each of the four maximum possible block inputs and for the block output.
- Background color of function blocks.
- Background color of special flags.
- Color of parameter box lines connecting parameter boxes from each other.

You can reset color on the chosen field by choosing different color panels from Swatches, HSV, HSL, RGB, CMYK and Standard.

The preview area shows your color selection.

2.8.5.43 Tools -> Options: UDF (OBA7 and OBA8 only)

Use this command to configure the UDF library.

A UDF library can contain two types of elements: a single UDF (.lma) file and a folder with multiple UDF files.

You can add or remove UDF files or folders in the dialog.

UDFs added to the UDF library appear immediately in the block tree, and are available for use in the circuit program.

2.8.5.44 Tools -> Options: CSV Separator

Use this command to choose whether to separate items in the CSV-format log file by semicolons or by commas.

2.8.6 Window menu

From the Window menu, you can arrange your circuit program windows on the desktop. You can duplicate existing circuit programs and split the windows to obtain a clearer overview of large programs. The following window options are available:

- Undo Split (Page 122)
- Split into two Windows (Page 123)
- Split into three Windows (Page 123)
- Selection list (Page 123)

2.8.6.1 Window -> Undo Split

You can use this menu command to undo all splits of a circuit program window.

2.8.6.2 Window -> Split into two windows

LOGO!Soft Comfort allows you to split the diagram editor window into two windows.

You can drag one diagram to the other window in order to view different areas of this diagram. You can then use the scroll bars to view or modify the elements not displayed in either window.

You can also copy one diagram to the other window to compare two circuit programs or to modify the pasted diagram.

The split, of course, affects only the window, but not your circuit program. These changes, take effect throughout the circuit program because only the window is split, but not the circuit program.

In project mode, every time you add a LOGO! Base Module in the network view, LOGO!Soft Comfort creates a corresponding program at the same time in the diagram editor frame. You can edit one window at a time. Move your mouse in the desired window frame and click the left mouse button on that window to switch highlight to it before operations. You can also click the device in the network view when working in project mode.

Note

Bilateral programming

LOGO!Soft Comfort supports network programming between two split windows. For more information on two-side programming or namely bilateral programming, see Two-side programming (Page 153).

Note

If you accidentally close a diagram in project mode, you can double-click the device in the network view frame to show the diagram again.

2.8.6.3 Window -> Split into three windows

LOGO!Soft Comfort also supports to split diagram editor window into three windows.

The items to note are the same as Window -> Split into two windows (Page 123), see that section for more information.

2.8.6.4 Window -> Selection list

The selection list at the end of the Window menu shows you all the windows you have opened on the programming interface. You can use this selection list to quickly switch between windows.

2.8.7 Help menu

This menu provides you with help and information on LOGO!Soft Comfort.

- Contents (Page 124)
- Context-sensitive help (Page 125)
- Update Center (Page 125)
- About (Page 126)

2.8.7.1 Help -> Contents

The Online Help

The online help quickly and reliably provides you with information about program and network configuration, tools and the creation of circuit programs and network projects with LOGO!Soft Comfort.

Topics of the Online Help

The User interface (Page 46) section describes the user interface with its toolbars and the LOGO!Soft Comfort menus in detail.

Refer to the Tutorial (Page 127) for a quick and easy introduction to the basics of operating LOGO!Soft Comfort, its circuit programming features and its new project networking features.

Towards the end of this section you will find an extensive Practical example (Page 168) that takes you through all the steps of circuit program and network project creation.

The Sample applications (Page 181) section introduces a few applications for LOGO!.

The Reference material (Page 191) chapter contains the following subsections:

- The Constants and connectors (Page 191) , Basic functions (only the FBD Editor) (Page 207) and Special functions (Page 212) subsections provide you with information about the various elements of a circuit program.
- The Circuit programs (Page 356) subsection provides information on memory requirements, circuit program limits for LOGO!, and additional information about blocks.
- The Network projects (Page 368) subsection gives an overview of the network project.
- The Data Log profile (Page 339) subsection gives information about the Data Log.
- The UDF (Page 341) subsection provides information on the UDF (User Defined Function block).

The Tips and Tricks (Page 369) section includes information that supports your daily tasks with LOGO!Soft Comfort.

The online help includes an **index** as well as a **full text search** feature for keyword and terminology based searches.

Help for blocks

If you double-click a block in the circuit program, you receive a window with parameters and settings for the block. If you then click the Help button in this window you receive the Help for this block in its own window.

Alternatively, you can right-click a block in the circuit program and select **Help** from the shortcut menu.

2.8.7.2 Help -> Context-sensitive help

 → Help **Context-sensitive help**

To display help on an object, first click the context-sensitive help icon (see above) and then the object.

Result: A window opens with information on this object.

You can also right-click objects on the programming interface and select **Help** from the shortcut menu to display a corresponding help topic.

The standard toolbar (Page 34) also contains an icon for this menu command.

2.8.7.3 Help -> Update Center

Update Center

The Update Center helps you to install additional languages, program add-ons, service packs and new versions for your LOGO!Soft Comfort.

Update and upgrade

If you update the software within the same main version, then this is an update. For example, you can update LOGO!Soft Comfort Version 4.0 to Version 4.1. You can only update via the Internet.

If you update the software to a higher main version, then this is an upgrade. For example, you can upgrade LOGO!Soft Comfort Version 6.1 to Version 7.0. You can upgrade from either the Update Center or a DVD-ROM.

How to use the Update Center

Follow these steps to perform an update/upgrade:

1. Select whether you want to update/upgrade LOGO!Soft Comfort via the Internet or using your local file system (DVD-ROM, floppy or hard disk drive).
2. If you choose to update/upgrade LOGO!Soft Comfort from your local file system, then you are prompted to enter the folder path in which you save the updates/upgrades. If you update/upgrade LOGO!Soft Comfort from the Internet, then the correct Internet address is already preset in the Settings Internet Update. If you are not connected directly to the Internet, then you must specify a proxy server. Consult your network administrator in this regard. An Internet connection is then created.
3. You are then shown all the updates/upgrades available for your software version. Select the desired updates/upgrades. If you are updating LOGO!Soft Comfort from the Internet, then your selected updates/upgrades will be downloaded and installed.
4. If you are updating/upgrading LOGO!Soft Comfort via the Internet, you are prompted to manually close the Internet connection when you have completed these actions.

LOGO!Soft Comfort is closed automatically when the update/upgrade is completed. The functionality of the installed update/upgrade is available to you after you restart LOGO!Soft Comfort.

Possible errors

When installing an upgrade/update, if you receive the error message **Does not agree with magic number**, this means the upgrade/update file **Setup.exe** has not been executed fully.

In this case, download the upgrade/update file from the Internet again and ensure the file is transferred completely.

2.8.7.4 Help -> About

The **General** tab displays the version number and the release version of your LOGO!Soft Comfort software.

The **System** tab provides you with information on the version of the Java Runtime environment used, the program paths, the installed operating system and on the memory used.

Tutorial

3.1 Prerequisites for working with the tutorial

To use this tutorial, you must be familiar with PC operation and you must know how to create a function block diagram. To download your circuit programs, you also need a PC cable, SD card or Ethernet cable for connecting the PC interface to your LOGO! device.

3.2 Getting started with program creation

You are going to learn the basics of working with LOGO!Soft Comfort by creating a simple circuit program and simulating it on your PC. Towards the end of this chapter, you will find a few sample applications (Page 168) for LOGO!Soft Comfort, and information on how to prepare, transfer and archive your application.

If necessary, review the elements of the user interface (Page 27) before beginning the tutorial.

Factory door (Page 183)

Air-conditioning system (Page 181)

Heating control (Page 184)

Fill station (Page 187)

3.2.1 Creating a circuit program

Developing a circuit program

Perform these tasks to develop a circuit program:

1. Create a new circuit program (Page 128).
2. Select blocks (Page 128)
3. Place the blocks (Page 128)
4. Configure and comment the blocks (Page 129)
5. Connect the blocks (Page 130)
6. Optimize the circuit program (Page 135)
7. Save the circuit program (Page 140)

Note that not all blocks are available (Page 132) under all circumstances.

3.2.1.1 Creating a new circuit program

After you start LOGO!Soft Comfort, you can begin to create a new circuit program.

To create a new circuit program, select the **File -> New** menu command or click the **New** button in the standard toolbar.

 → File → new (Page 47)

LOGO!Soft Comfort opens the FBD Editor (or the default editor specified under Tools/Options/Standard Editor), and then you can create the new circuit program in a new window on the programming interface.

Click the small arrow on the right side of the **File → new** icon to open the LAD, FBD or UDF Editor.

3.2.1.2 Selecting blocks

Your first programming step is to select the blocks for your circuit program. Determine the order in which you want to insert the I/O and the standard/SFB blocks.

Under Co in the programming toolbar, you find the constants and terminals, that is, a collection of I/O and constant signals. Under GF, you find the basic logic functions of Boolean algebra: standard digital logic blocks. Under SF you can find the special functions. You can also access the respective function groups via the function keys.

 or [F6] → Constants/connectors (Page 191)

 or [F8] → SFBs (Page 212)



Only in the FBD and UDF Editors:

 or [F7] → Basic functions (Page 207)



A quick and easy way of selecting blocks and placing them into your circuit program (Page 369)

3.2.1.3 Placing blocks

Click the icon group that contains the required block or, as an alternative, click the function key (Page 31). The programming interface displays all blocks belonging to the selected Basic function group.

Example for the FBD Editor:

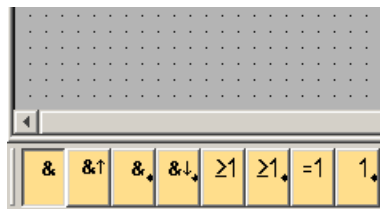

You can insert the selected function on your programming interface by clicking the programming interface. You can select other functions with the mouse before you place them.

Example for the FBD Editor:

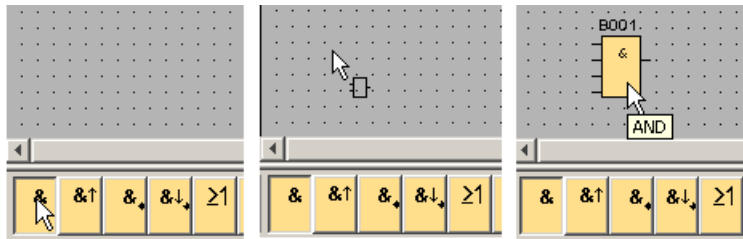

There is no need to align the blocks right away. A precise alignment of the blocks at this time does not make sense, until you have interconnected them and entered the comments in your circuit program.

Information on block numbering is found here (Page 367).



How to quickly and easily select blocks and place them into your circuit program (Page 369)

3.2.1.4 Editing blocks

Shortcut menus

Right-click an object opens a shortcut menu that offers you various object editing options. The editing options depend on the selected object:

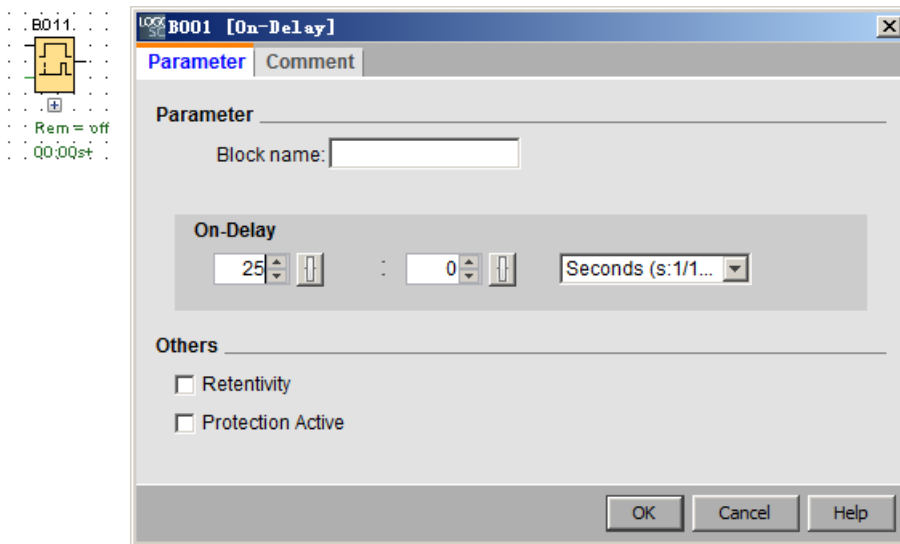

Objects consist of not only blocks and connecting lines, but also the programming interface and toolbars.

You can also call Help -> Context-sensitive help (Page 125) on the selected object in the shortcut menu.

Configuring blocks

Double-click a block to configure block properties. The properties dialog includes a Comment tab as well as various parameter tabs for the SFBs (Page 212), and for some of the basic functions (Page 207) and constants and connectors (Page 191). You specify here the values and settings for your blocks. You can click the **Help** button to get help on the parameters of the selected block.

You can recognize special functions by the green lettering below the block on the programming interface.

3.2.1.5 Connecting blocks

To complete the circuit program, you must interconnect the blocks. In the programming toolbar (Page 37), select the block connection icon.

Example for FBD:

 → Connector (Page 39)

Click the connector of one block and drag the mouse to a connector of another block to make a connection between the two blocks. LOGO!Soft Comfort connects the two terminals.

Example for LAD:

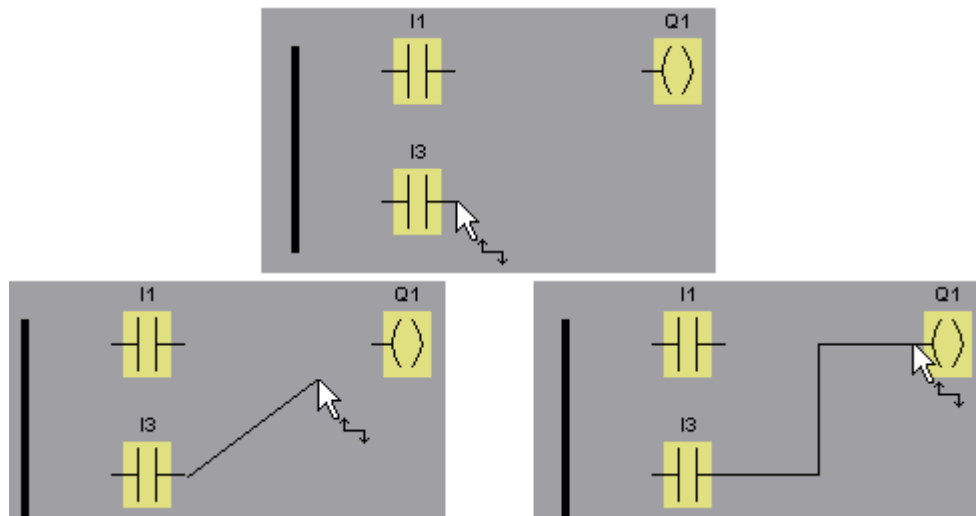

LOGO!Soft Comfort offers you a further option of connecting blocks when you right-click the input or output of a block. In the shortcut menu, click the **Connect with block** menu command to display a selection list that contains all blocks available for your connection. Click the relevant target block. LOGO!Soft Comfort then draws the connecting line. This method is especially useful for connecting a source to a target block over a greater distance on the programming interface.

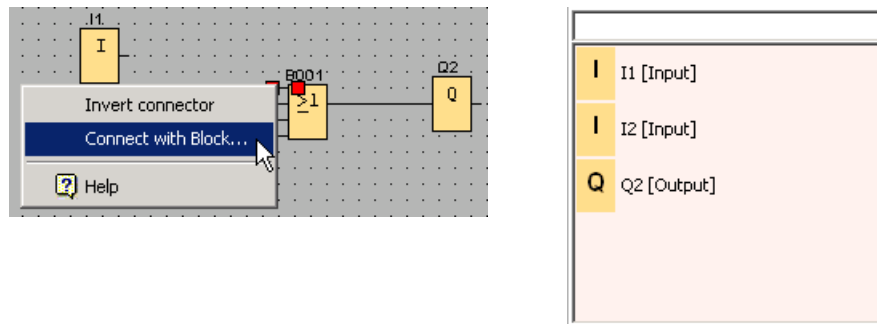

Note on the LAD Editor:

Do not forget to connect the I/O to the bus bar on the left edge of the editor window.

Tips on connecting blocks

When you connect an input to an output, or vice versa, LOGO!Soft Comfort displays a tooltip that shows the connection. Release the mouse button to snap the line onto the indicated input.

You can refer to the short information (tooltips) in LOGO!Soft Comfort for additional help on circuit programming. Hover over a block to see the name of the block. Hover over a block input to see the name of the input.

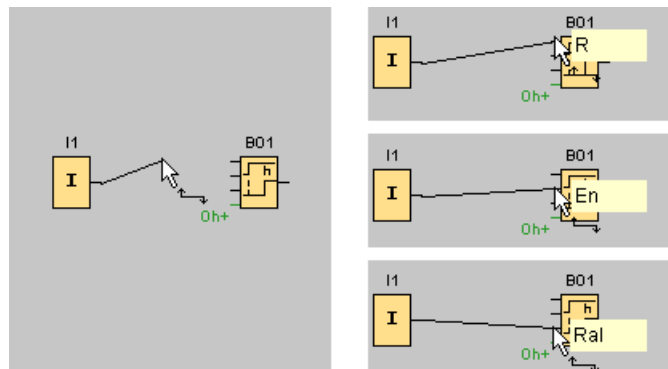

LOGO!Soft Comfort displays a blue frame around the mouse pointer when it can connect to an block input (pin)

Rules for connecting blocks

The following rules apply to the connection of blocks:

- You can connect a single input to multiple outputs.
- You cannot connect multiple inputs to a single output.
- You cannot interconnect I/O in the same path of a circuit program. Recursion is not permitted. Interconnect a flag (Page 195) or output (Page 194) if necessary.
- SFBs (Page 212) also have green "connectors". These do not represent connecting pins, but are used instead for assigning the parameter settings.
- Analog I/O cannot be connected to digital I/O.

Multiple connections

You can connect I/O to existing connections.



A quick and easy way of connecting blocks in large circuit programs (Page 370)

3.2.1.6 Availability of blocks

Hardware defaults

The memory space (Page 365) and the device series (Page 357) of your LOGO! determines:

- How many blocks you can use in the circuit program
- Which blocks are available to create your circuit program

After you have created a circuit program, you can call the Tools → Determine LOGO! (Page 90) menu command or press the function key (Page 31) [F2] to display an Info Window that shows you which LOGO! devices are available for executing your circuit program.

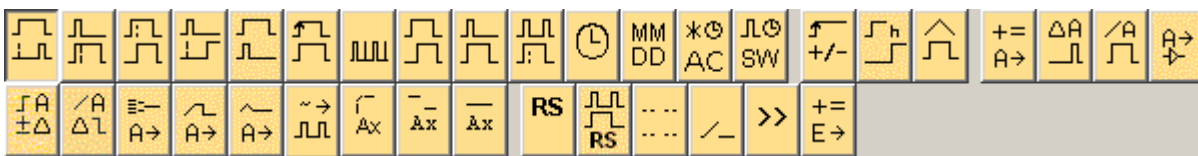

The blocks which are not available for your selected LOGO! are not displayed.

Optimizing the circuit program

Should you determine in the course of creating your circuit program that a LOGO! device is unable to handle your circuit program, you should first make use of all the functional resources offered to you by the LOGO! device. You could, for instance, replace memory intensive blocks (Page 360) with a structure consisting of several blocks, which altogether require less memory space.

If the various optimization attempts are unsuccessful, then you can use an additional LOGO!, or optimize/simplify the functionality of your application.

3.2.1.7 Parameter box overview

Click the small box below the block to open the parameter box. Not all blocks have parameter boxes.

A parameter box describes each parameter in one line including its name, value and unit.

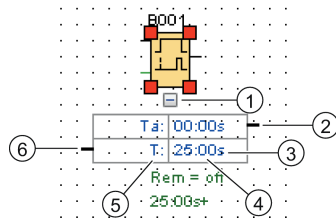

- | | |
|--------------------|-------------------|
| ① show/hide button | ④ parameter value |
| ② output connector | ⑤ parameter name |
| ③ unit | ⑥ input connector |

For information on using a parameter box, see [Editing a parameter box \(Page 134\)](#).

3.2.1.8 Editing a parameter box

To create, cut, or delete a connection line, follow these steps:

1. Click the connector of one parameter box and drag the mouse to a connector of another parameter box to make a connection between the two parameter boxes.

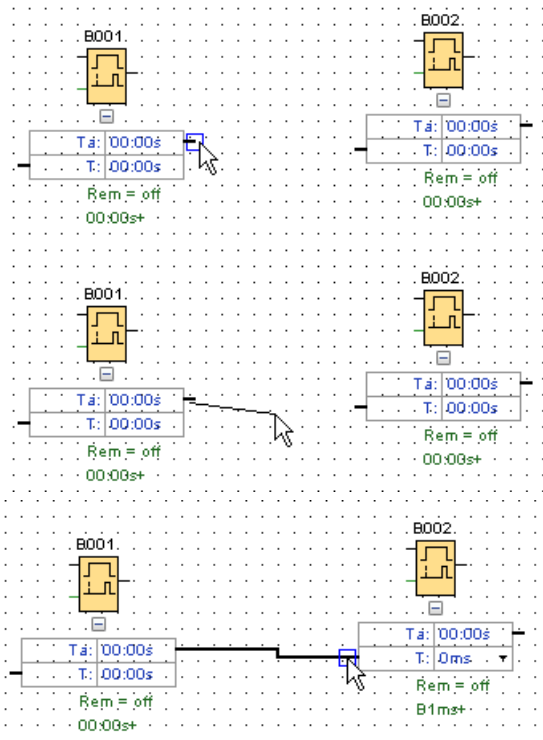

2. You can cut and rejoin the reference line. For information on cutting the reference line, see [Cut/Join \(Page 39\)](#).
3. You can delete the reference line. Deleting a connection line means deleting their reference relationship. For information on deleting a reference line, see [Edit → Delete \(Page 59\)](#).
4. You can hide or show a parameter box line. For information on hiding/showing a parameter box, see [shown/hidden parameter box line \(Page 43\)](#).

Customized reference line color

You can define the reference line color in color option dialog. On how to set the color of reference line, see section [Tools -> Options: Colors \(Page 122\)](#) for more information. After you select a color, LOGO!Soft Comfort uses that color for all reference lines.

Tips on connecting parameter boxes

After you connect a line from an output connector to an input connector, or vice versa, a pop-up tooltip opens to show the connection. Release the mouse button to snap the line onto the indicated input.

You can refer to the short information (tooltips) in LOGO!Soft Comfort for additional help on circuit programming. Hover over a block to see the name of the block. Hover over a block input to see the name of the input.

Rules for connecting parameter boxes

The following rules apply to the connection of blocks:

- You can connect a single input to multiple outputs.
- You cannot connect multiple inputs to a single output.

To change a time unit

When the time-type parameters refer to another parameter, you can change the units of the parameter by left clicking the small arrow and selecting the unit you want in the drop down list.

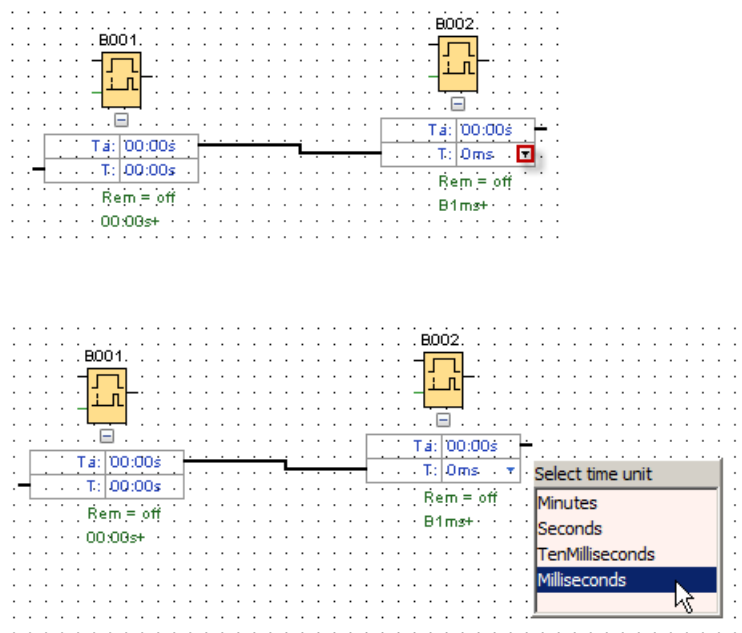

3.2.2 Editing the layout

The circuit program is ready for use after you have inserted and connected the blocks. To optimize the appearance of your layout, you can reposition the blocks and lines.

3.2.2.1 Selecting objects

Before you can move or align objects you must first select them. Click the selection tool in the programming toolbar or press the [ESC] key to activate the selection tool.

 or [ESC] → Selection (Page 38)

You select single blocks or connecting lines with a simple mouse click. To select groups of blocks or connecting lines, you "capture" them with the mouse. To "capture" objects, keep the left mouse button pressed and draw a frame around them and then release the mouse button. LOGO!Soft Comfort highlights the "captured" blocks by small red squares at the corners of the selected fields.

Sample for the FBD Editor:

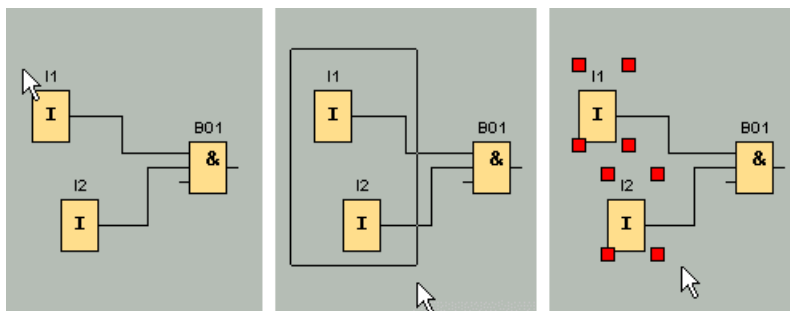

In addition to the selection of single objects by a simple mouse click or highlighting object groups by "capturing", there is a further selection option: Under "optional selection", mark the objects one after the other by holding down the [Ctrl] key while you select the objects. To remove an object from the selection, hold down the [Ctrl] key and click a selected object once again.

3.2.2.2 Editing selected objects

You can delete single or grouped objects with the [Del] key, or move them with drag and drop or use the keyboard. The cursor keys allow fine positioning in very small steps. However, do not set the snap function in the Format → Grid menu when doing so. You can also cut, copy and paste selected objects by means of the relevant toolbar icons.

 → Cut a Selected Object (Page 59)

 → Copy a Selected Object (Page 60)

 → Paste a Selected Object (Page 60)

Editing selected connecting lines

LOGO!Soft Comfort indicates a selected connecting line by round and square blue handles. You can use the round handles to move the lines at a right angle into the direction in which they extend. You can use the square handles to reassign the beginning or end of a line. Move the lines by dragging the round handles.

Example for the FBD Editor:

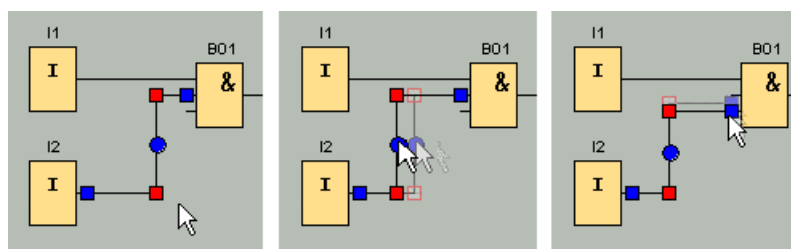

If you do not connect a line to a suitable target connector, LOGO!Soft Comfort reconnects it to its initial position after you "release" the mouse button.

3.2.2.3 Replacing blocks

To replace a block in your circuit program with another function block, follow these steps:

1. Insert the new block above or below the block you want to replace.
2. Rewire the connecting lines of the old block to the new one as described under "Editing selected connecting lines" in Editing selected objects (Page 136).
3. After having rewired all the connecting lines, you can delete the old block and move the new block into this position.

Example for the FBD Editor:

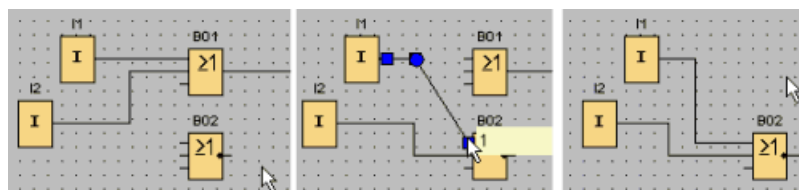

By keeping this block replacement order, you can maintain your connecting lines. If you first delete the old block, you also delete its connections, which means you have to recreate all connections.

In a LOGO! 0BA7 and LOGO! 0BA8 Base Module, you can directly replace an old block by dragging the new block from the block tree to the old block figure with the left mouse key pressed.

3.2.2.4 Cutting connections

It may turn out to be difficult to interpret the layout of a large circuit, especially if it contains many line crossings. You can clean up your connection layout, using the "Cut/Join" tool of the programming toolbar.

 → Cut/Join (Page 39)

Click a connection after you have called this tool. The selected connecting line is graphically split. However, the link between the blocks remains active.

The open ends of the cut connection are now shown with arrowhead icons, which indicate the direction of the signal flow. Above the icons, you can now see the cross-references, including the page number of the circuit program, the block name and the number of the block terminal that is connected to the open link.

Right-click the line connecting the two blocks you want to cut, then select the cut command.

You can also cut a group of connections, using the Edit → Cut Connections menu command. Before you cut any connections, you can also set the cutting criteria, for example, cut all connections routed through blocks.

Example for the FBD Editor:

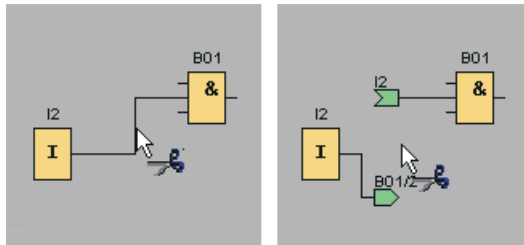

The connection is closed again by clicking on its open end while the Cut/Join tool is active. Optionally, you can close the connection by right-clicking on an open end and calling the **Join** menu command.

Example for the FBD Editor:

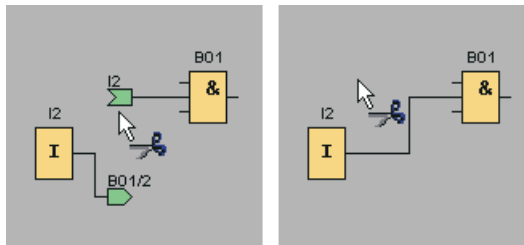

You should not use this tool to edit smaller circuit programs. In most cases you can optimize the layout by repositioning the icons.

Applications and advantages

Large and complex circuit layouts may contain numerous line crossings, thus making it more or less difficult to interpret the circuit. In such cases, the Cut/Join button is a highly effective means of clearing up the circuit layout.

You can quickly jump to the partner connector by right-clicking the open end of a cut connection. This opens a shortcut menu, in which you can select the **Go To Partner** menu command to jump to the partner end of the cut connection.

Another advantage of the Cut/Join tool is its utilization for circuits extending across more than one printable page, that is, across a page break. The connecting lines of two circuit blocks which are shown on different pages are cut without cross-reference. However, if you cut such connections using the Cut/Join tool you generate a cross-reference pointing to the source or the connection target.

Example for the FBD Editor:

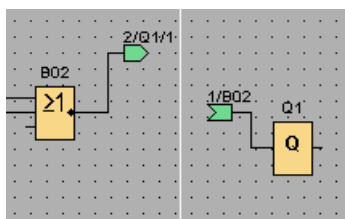

3.2.3 Documentation and saving

3.2.3.1 Documentation of the circuit program

Labels

You can create block-independent and associated labels using the text tool of the programming toolbar. To do so, click the text tool.

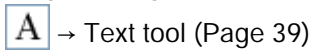

When this icon is active, open a text input box by clicking a free area of the programming interface or a block. After you have entered the label text, simply click anywhere outside the label window or press the [ESC] key. The window is closed and the label text is displayed in the diagram. That label can now be selected, moved or aligned.

Example for the FBD Editor:

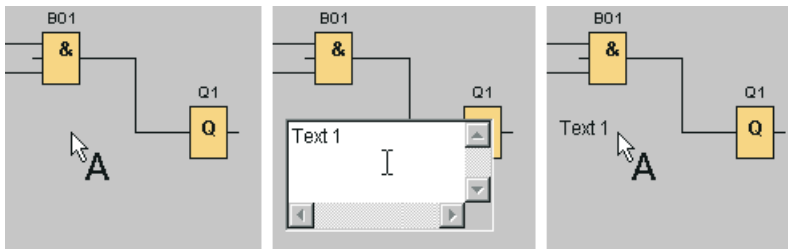

Block independent and associated text

Click a free area of the programming interface to create a block independent label. A label can be edited by calling the text tool and then clicking on the relevant label.

By clicking a block with the text tool, you create an associated label, namely the block comment. You can also input and edit this comment in the comments tab of the block properties dialog. The block comment can be used, for example, to name a block or to describe the task of the block within your circuit.

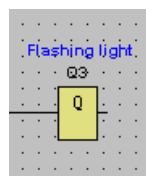
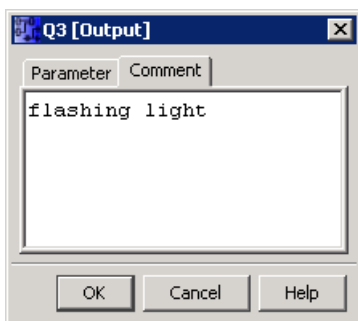

If you select a block with an associated label, the text is not marked. However, when you move the block, you also move the label. When you copy or cut the block, only the block itself is copied to the clipboard. A cut operation deletes the associated label. However, the

associated label can be selected and moved, copied, cut or pasted individually. An associated label that is pasted from the clipboard is no longer associated with the block.

In Edit → Input/output Names (Page 63) you can assign block numbers and connector names to the I/O.

Comment linking and connector comments

Text comments can be linked to function blocks or to cut connectors.

To link the text and the function blocks, left-click the yellow cubic in the center of the text when the text is selected and move the pointer to the block you want link to with the left mouse button pressed. When a function block or a cut connector is linked to a comment, its frame color is green.

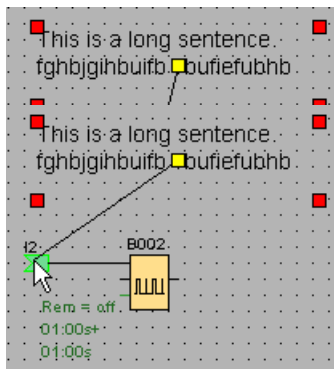

A linked comment moves consistently with the figure to which it is attached. You can adjust the relative position of the comment to the figure, as you do a block comment.

3.2.3.2 Opening and saving a circuit program

Opening a circuit program

You can always click the File open icon to open a circuit program for further editing. You open a list of recently opened programs by clicking on the arrow icon on the right side of the button.

 → File Open (Page 47)

Saving a circuit program

Click the File save icon in the standard toolbar to save the circuit program.

 → File Save (Page 49)

The circuit program/project is saved under the name it was opened with, while older versions are overwritten. When you initially save a file, you are prompted to specify a program path and name.

3.3 Simulation of a circuit program

3.3.1 Starting the simulation

Use the Tools → Simulation (Page 95) menu command or the simulation icon  in the programming toolbar to place your circuit program in simulation mode.

At the start of simulation, LOGO!Soft Comfort verifies the circuit program and shows any existing errors in the Info Window, which you can view by calling the View → Info Window (Page 68) menu command or by pressing the function key (Page 31) [F4]. You can also use the function key [F2] in the Info Window to display the LOGO! modules capable of running your program.

In simulation mode, you have the simulation toolbar and status window (Page 35) available for performing the simulation and for observing and controlling the behavior of your circuit program.

Note

You can simultaneously simulate only three of your circuit programs. A warning dialog reminds you when you try to simulate the fourth one.

3.3.2 Layout of inputs

LOGO!Soft Comfort displays inputs as key or switch icons, with the name below the icon. An open input represents an inactive switch. When you click the icon, LOGO!Soft Comfort switches it on and indicates that with red.

 → Icon for pushbutton I1, not actuated → open input

 → Icon for pushbutton I1, actuated → closed input

 → Icon for pushbutton I2, not actuated → open input

 → Icon for pushbutton I2, actuated → closed input

Layout of analog and frequency inputs

You can set the analog voltage or frequency values for analog and frequency inputs by means of a slide resistor. Click the relevant block to display and operate this slider directly in the diagram. If you want to specify a more precise value, enter it directly or set it directly via the up/down keys beside the input window.

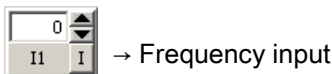
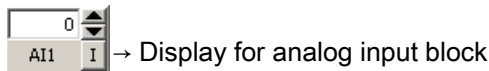

Input functions

You set the response of your inputs for simulation purposes with the Tools → Simulation Parameters (Page 95) menu command.

3.3.3 Layout of the outputs

In simulation mode, LOGO!Soft Comfort displays the outputs Q (Page 194) and the flag M (Page 195) as outputs.

LOGO!Soft Comfort indicates the status of an output or flag by a light or dark bulb icon. LOGO!Soft Comfort displays the name of the output in your circuit program below this icon.



→ Status display of output Q1 → Output switched off



→ Status display of output Q1 → Output switched on

The icon only indicates the status of an output. You cannot turn the output on or off by clicking the icon.

3.3.4 Set output

In simulation mode, you can set a block output by right-clicking the digital output of the block. With this command, you can set the output irrespective of the current status of the block. The output remains set until you enable it again or you end the simulation.

This way you can use a simulation to check how a circuit program will react to certain states.

3.3.5 Power failure

The user can simulate a power failure by clicking the **Power** icon to interrupt the power supply to all inputs.



→ Power icon, not actuated



→ Power icon, actuated → Simulated power failure

You can use this function to test the reaction of the circuit to power failure and restart, as well as its retentivity. In contrast to the start of simulation, retentivity is relevant for the "Power failure" function. The start of a simulation is equivalent to the "Load Program" function in LOGO!. LOGO!Soft Comfort resets all values, including the retentive values.

3.3.6 Layout of message texts

After you start simulation, the simulation toolbar contains a toggle button that shows the message window.



If you right-click the entry in the message text, you can see from which block the entry in the message text originates. You can also select this block in the circuit program (**Go to Block**) and call up the properties of this block (**Block Properties**).

When you configure a LOGO! 0BA6 or 0BA7 message text (Page 315), you specify whether to display the message text on one destination (the LOGO! onboard display or LOGO! TD) or on both. If you specify to display a message text on one destination, simulation mode shows active message texts for that destination in one window. If you select to display on both destinations, simulation mode shows active message texts for the LOGO! onboard display and the LOGO! TD in separate windows. If you use LOGO! 0BA5 message texts (Page 327) in your circuit program, the message text destination can only be the LOGO! onboard display.

Standard View

The following display shows you the standard view with the message destination on the LOGO! display only:

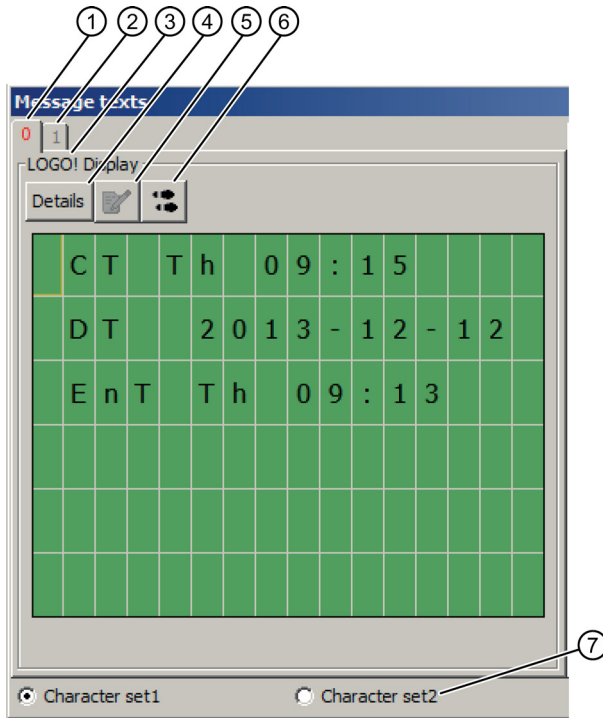

- ① Tab of the displayed message text stating the priority.
- ② Tab of another message text.
- ③ Name of the message destination. It can be "LOGO! onboard display" or "LOGO! TD", depending on your setting.
- ④ **Details** button
If you click this button, the view changes and you receive more detailed information in the Detail View (see below).
- ⑤ **Enter value manually** symbol
Before you can use this function you must first click a changeable entry in the message text. If you then click this button, you can manually change the current value. Alternatively you can also double-click an entry to manually change it.
- ⑥ **Go to Block** symbol
If you click this button, the special function belonging to the message text is selected in the circuit program.
- ⑦ Options for different character sets, when the circuit program does not use M27 (Page 195) to determine the character set selection.

Detail View

The following display shows you the detail view with the message destination on the LOGO! TD only:

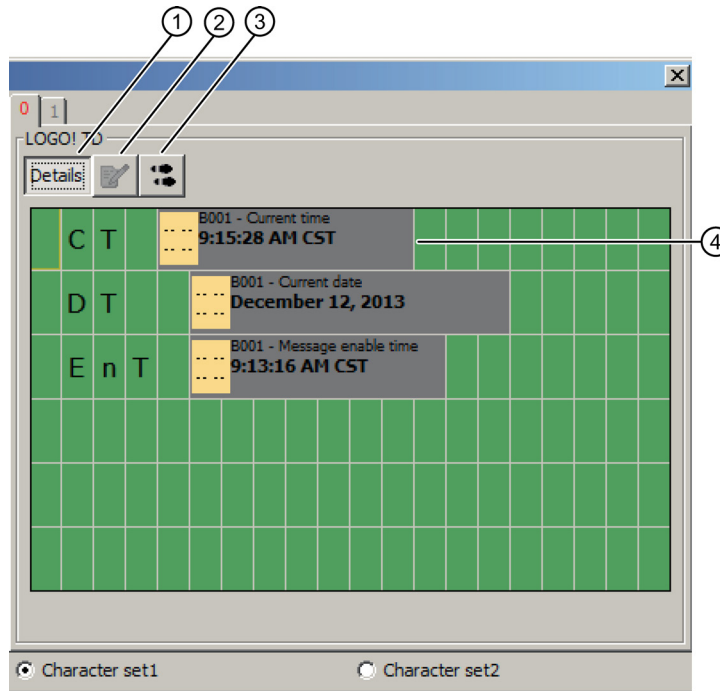

- ① **Details** button
If you click this button, you return to the standard view (see above).
- ② **Enter value manually** symbol
Before you can use this function you must first click a changeable entry in the message text.
If you then click this button, you can manually change the current value.
Alternatively you can also double-click an entry to manually change it.
- ③ **Go to Block** symbol
If you click this button, the special function belonging to the message text is selected in the circuit program.
- ④ Entry in message text with information regarding the block from which the entry originated.

View for separate LOGO! onboard display and LOGO! TD message text displays

If you select the option "Show message text for the LOGO! TD in a separate window" from the Tools -> Options: Simulation (Page 121) dialog and specify that the message destination is on both the LOGO! onboard display and the LOGO! TD, simulation mode shows active message texts for both modules in separate windows.

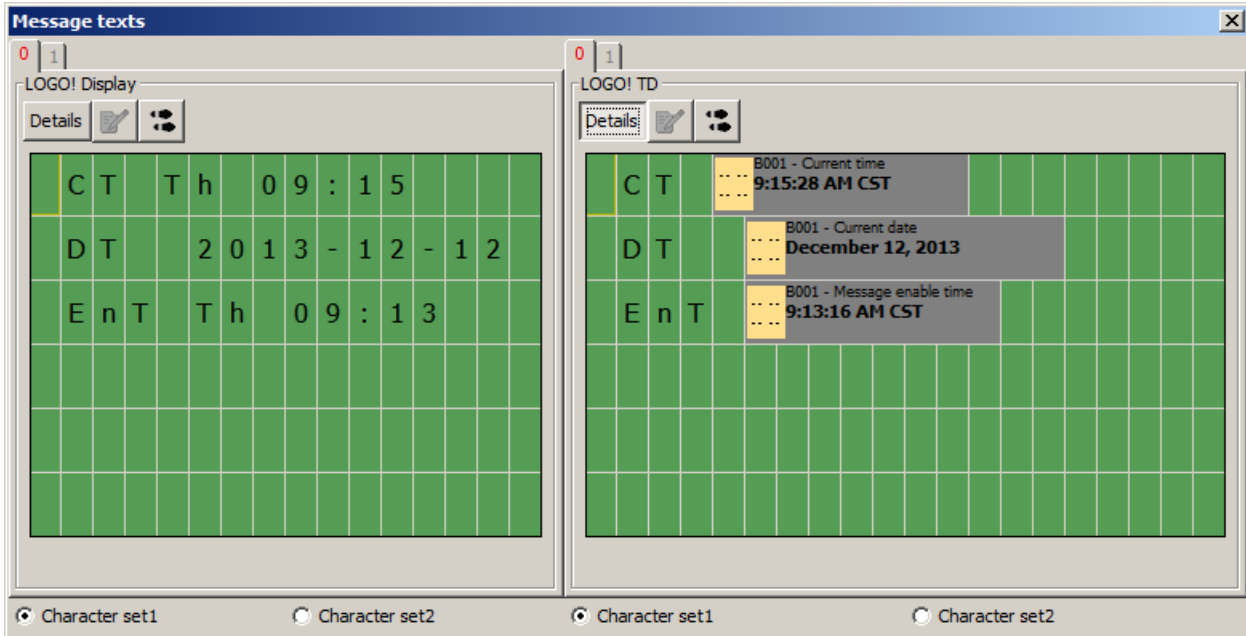

3.3.7 Parameter assignment in simulation mode

You can double-click a block during simulation to open the block properties dialog. Here, as in programming mode, you can modify comments or parameters.

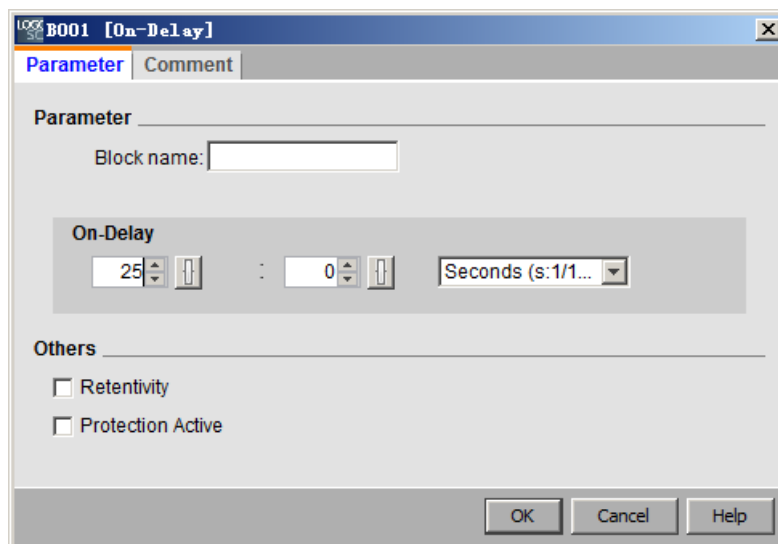

Simulation mode shows you the actual parameter values. This analysis option allows you to test the reaction of your circuit program. You can open several parameter assignment windows concurrently in simulation mode.

3.3.8 Alternative operation

You can click directly the inputs to switch them on or off.

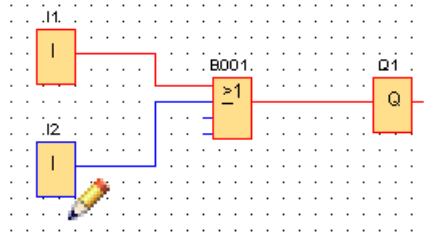

3.3.9 Controlling the simulation time

The simulation mode of LOGO!Soft Comfort allows you to test your circuit program on a timed basis, or over a specific number of cycles. You can even modify the time of day to test timer operations in your circuit program. See the time control (Page 35) section in the simulation toolbar topic for more information on the capabilities you have in simulation mode.

3.3.10 Simulating network communication (0BA7 and 0BA8 only)

In simulation mode, LOGO!Soft Comfort creates a virtual network simulation group in the background to support network simulation. You can put one or more circuit programs into this group. You can create only one simulation group at a time and the IP address of each circuit program in a group must be unique. The following figure shows three circuit programs in a simulation group.

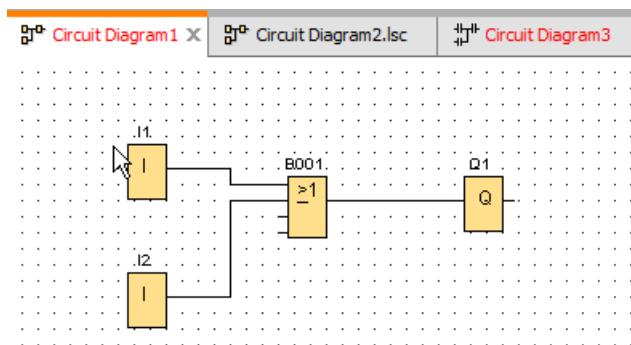

After you start simulation, the simulation toolbar contains a toggle button, which is available only after you configure the Ethernet connection information.

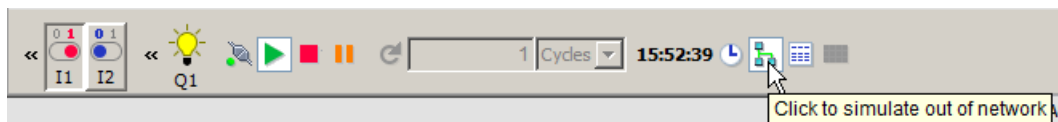

If you click the network simulation button, LOGO!Soft Comfort displays the circuit programs in the simulation group. The following figure shows a circuit program that is being simulated.

3.3 Simulation of a circuit program

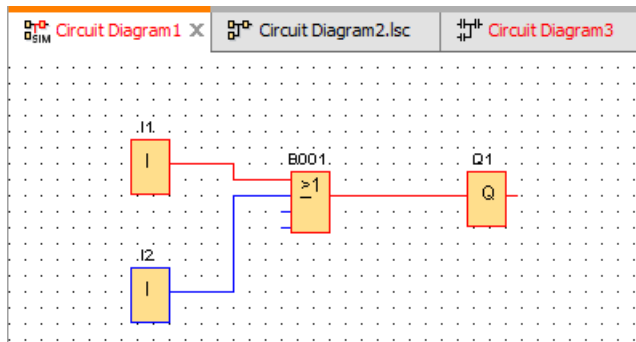

You can remove a diagram from the simulation group by clicking the button "Simulate out of network". After you remove it, LOGO!Soft Comfort continues to simulate the circuit program but without communication to the other circuit programs.



For circuit programs without the network feature, simulation is the same as in LOGO! 0BA6.

3.3.11 Data table (0BA7 and 0BA8 only)

You can watch Variable Mapping (VM) values in the Data Table. The simulation toolbar contains a toggle button for opening or closing the display of the Data Table.

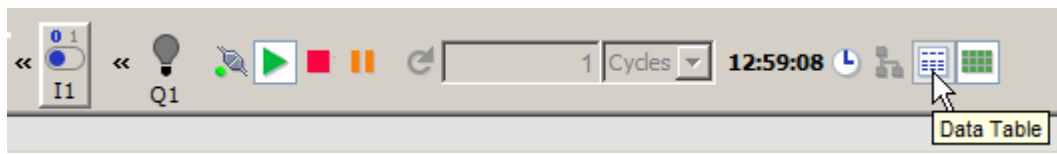

In the Data Table, you can enter VM addresses and choose the corresponding data types. LOGO!Soft Comfort displays the current values for the VM addresses that you provide. You can add new rows by right-clicking an existing row, or pressing the Enter key on the last cell of an existing row. You can enter new values in the New Value column for an existing VM address.

ID	Address	Type	Value	New Value
1	VW2	Signed	0	
2	VD5	Binary	2#0000_0000_0000_...	
3	VD30	Hex	16#0	

The table below shows the valid address types and memory ranges:

Address Type	Range
Bit	x.0 to x.7
VB	0 to 850
VW	0 to 849
VD	0 to 847
IB	0 to 2
QB	0 to 2
MB	0 to 7

For simulation, the values of the Data Table will be updated each cycle. For online test, the values are updated after each communication.

3.4 Getting started with project creation

You can learn the basics of working with LOGO!Soft Comfort by creating a simple circuit project and simulating it on your PC. The online help also includes a few sample applications (Page 181) for LOGO!Soft Comfort, and information on how to prepare, transfer and archive your application.

If necessary, review the elements of the user interface (Page 27) before beginning the tutorial.

3.4.1 Creating a Network project

3.4.1.1 Creating a new circuit project

After you have started LOGO!Soft Comfort, you can start to create a new circuit project.

To create a new project, click the **File** → **new** or click the **New** button in the standard toolbar in project mode.

 → File → new (Page 47)

Note

When you create a new project, the current project will be closed. If you haven't saved the current project, LOGO!Soft Comfort prompt you to save it.

3.4 Getting started with project creation

3.4.1.2 Creating a circuit project

Developing a circuit project

Perform these tasks to develop a circuit program:

1. Create a new project (Page 149).
2. Add a new device (Page 150)
3. Create a circuit program for the device (Page 127)
4. Save the project (Page 153)

3.4.1.3 Adding a new device

After you create a new project, you can start to design your network and add devices.

1. Double-click **Add new device** in the Network project tree.
2. Select Device in the Device list.
3. Set the IP address, subnet mask and the Gateway for the device in the configuration dialog. You can also change the device name in this window.

Alternatively, you can click the **Add new device** button in Networking toolbar (Page 44) to add a new device.

Note

When you add a new device in the Network view of project mode, LOGO!Soft Comfort automatically creates a new circuit program and displays it in the diagram editor. See "Creating a new circuit program (Page 128)", for more information.

3.4.1.4 Devices

Local PC

You use the local PC to create, edit, and configure the project and circuit program. For how to configure the local PC, see Configuring PC settings (Page 155).

When you add a new device, LOGO!Soft Comfort generates an Ethernet connection between the device and the local PC. You cannot modify the Ethernet connection line in the Network view.

LOGO! device

In the network view, you can add four types of LOGO! device:

- LOGO! 0BA7
- LOGO! 0BA7 slave
- LOGO! 0BA8
- LOGO! 0BA8 slave

The following display shows you the standard view of a device model for LOGO! 0BA8.

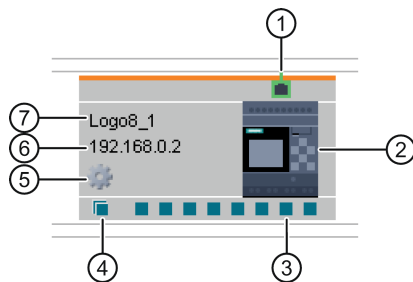

- ① Ethernet port This port shows the Ethernet port to other devices.
- ② Device image Device image
- ③ Normal connector You can create Ethernet connections between devices by connecting the normal connectors through drag-and-drop operation. For how to connect the normal connector, refer to *Configuring Ethernet connection, LOGO! to LOGO!*. (Page 157)
- Note: You can only connect a normal connector to a connector of another device. You cannot connect different connectors in one device to each other.
- ④ Dynamic connector You can connect a dynamic connector with a maximum of eight normal device connectors. When you create a connection between a dynamic connector and a normal connector of another device, LOGO!Soft Comfort automatically creates a client connection in the connect device.
- Note: Only 0BA8 devices have dynamic connector. A dynamic connector cannot be connected with other dynamic connectors.
- ⑤ Property icon You can open the device property panel by left-clicking the property icon.
- ⑥ Device IP When you connect a device in diagram mode, you must assign the IP address for a device before creating an Ethernet connection to or from the device.
- In network project mode, LOGO!Soft Comfort assigns a default IP address (for example, 192.168.1.1) when you add a new device to a project.
- ⑦ Device name Note: LOGO!Soft Comfort displays the device name, or the first 11 characters of the device name.

LOGO! slave

3.4 Getting started with project creation

In LOGO!Soft Comfort, you can only connect a LOGO! slave to a LOGO! device and you cannot create connection by dragging and dropping. You can only create the connection by connecting network blocks. For how to connect LOGO! devices, refer to Configuring Ethernet connection, LOGO! to LOGO! slave (Page 163).

S7 compatible device

In LOGO!Soft Comfort, you can only connect S7 to LOGO! devices, but not HMI, TDE or LOGO! slave. S7 has only one connector in LOGO!Soft Comfort, but you can create multiple connections between S7 and LOGO! devices(up to 100). For how to connect S7, refer to Configuring Ethernet connection, LOGO! to S7 (Page 164).

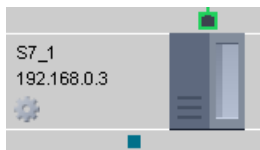

HMI

In LOGO!Soft Comfort, you can only connect HMI to a LOGO! device. For how to connect HMI, refer to Configuring Ethernet connection, LOGO! to HMI (Page 165).



LOGO! TDE

You can reserve a IP address for you LOGO! TDE in LOGO!Soft Comfort.



3.4.1.5 Opening and saving a circuit project

Saving a project

Click the save icon in the standard toolbar to save the project.

 → File Save (Page 49)

LOGO!Soft Comfort saves the project under the name it was opened with and overwrites the older versions. When you initially save a project, LOGO!Soft Comfort prompts you to specify a program path and name.

Saving a circuit program of a device

Right click the device, and select **Export** in the shortcut menu to save the circuit program.

Opening a project

You can click the File open icon to open a circuit project for further editing. You open a list of recently opened programs by clicking on the arrow icon on the right side of the button.

 → File Open (Page 47)

Importing a circuit program to a project

Right-click any blank space in the network view, and select **Import...** in the shortcut menu to import the circuit program.

Note

You can only import OBA7 and OBA8 circuit programs into a project.

3.4.1.6 Two-side programming

Project mode supports network programming between two diagrams. You can easily create the network connection and data transfer by drag and drop.

You can only use two-side programming between OBA8 devices in project mode

Transferring block data between two diagrams by two-side programming

Position the mouse pointer on the output connector of a function block. Press the left mouse button and hold it. Move the pointer from the source connector to the target input connector. Release the mouse button. LOGO!Soft Comfort connects the two terminals.

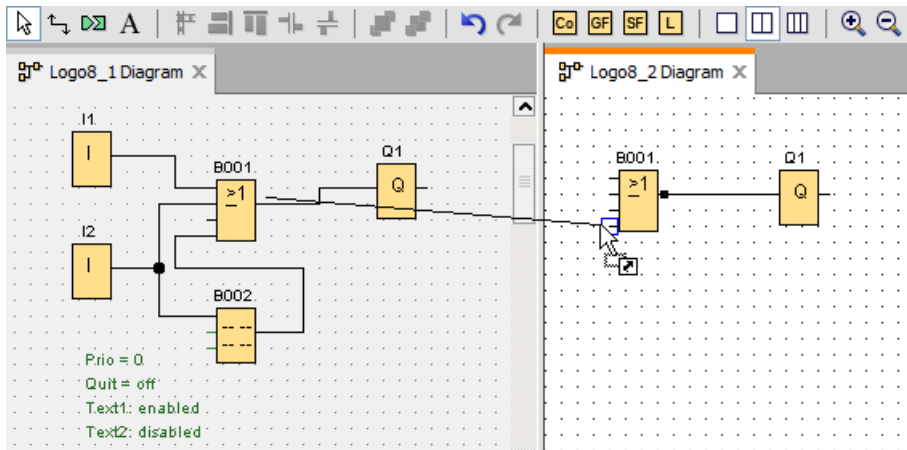
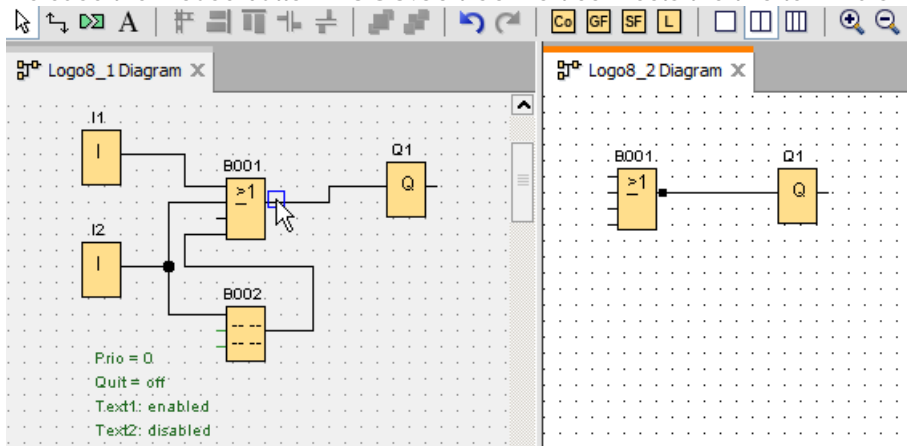

When you connect two function blocks in two separate circuit diagrams, LOGO!Soft Comfort creates a pair of network function blocks, including the Ethernet connection and data transfer mechanism. The green color indicates that the LOGO! device of the two circuits are connected in LOGO!Soft Comfort. The network function block turns to red if its LOGO! device loses the connection to the other LOGO! device in LOGO!Soft Comfort.

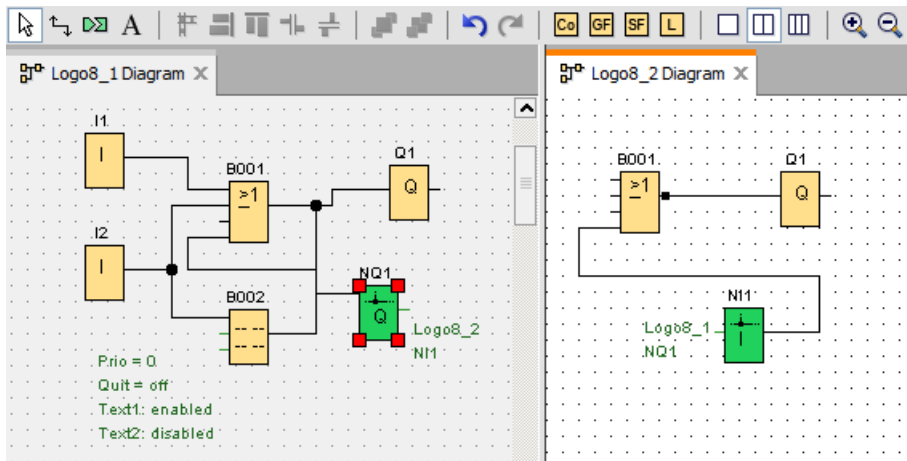

An alternative way to set up the connection

1. Insert a pair of network blocks (for example, NI/NQ) in the two diagrams.
2. Connect the NI to the block from which you want to get remote value.
3. Connect NQ to the block to which you want to transfer data.
4. Connect the NI and NQ.

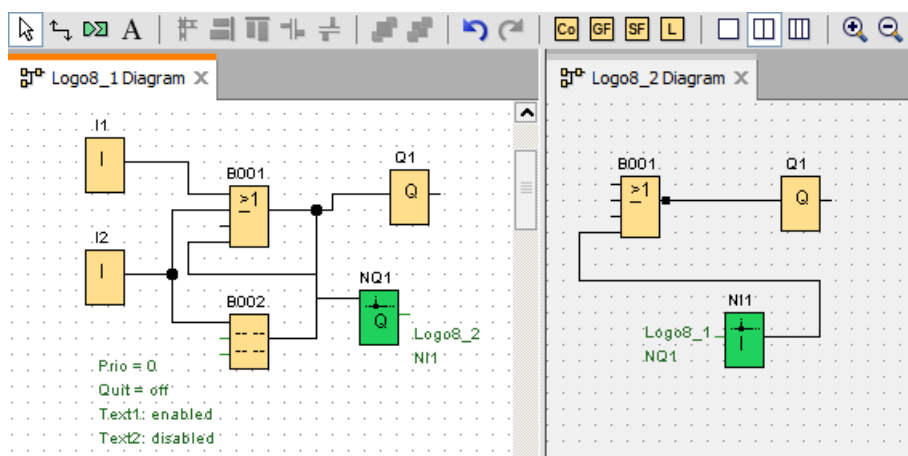

3.4.2 Device setting configuration

3.4.2.1 Configuring PC settings

The local PC running LOGO!Soft Comfort is the local device for the network configuration.

When you add new devices, LOGO!Soft Comfort connects them automatically to the local PC in the network view.

You can then configure the PC settings by clicking the  icon on the local PC image in the network view.

You can select the network interface that connects the local PC to the LOGO! Base Module from this dialog.

3.4.2.2 Configuring LOGO! offline settings

After configuring the local PC settings, you can then configure device offline settings by clicking the  icon on the device image in network view.

You can refer to the File -> Properties (Page 53) for detailed information.

3.4.2.3 Configuring LOGO! online settings

After connecting your device to the local PC, you are then able to configure the device online settings by clicking the  icon on the device image in network view frame.

You can refer to File -> Properties (Page 53) for detailed information.

3.4.2.4 Configuring settings for other standard devices

For other standard devices

If you have added SIMATIC HMI devices, SIMATIC S7 devices, a LOGO! TDE, or other devices in the network view, you can then edit the device name, IP address, subnet mask, and gateway for those devices. You can also browse files on your computer and import a project file with the settings for HMI and S7 devices.

3.4.2.5 Detecting device online status

After you configure the online and offline settings, you can go online and view online status for the devices.

Push the devices online to start scanning for any connected LOGO! Base Modules.

LOGO!Soft Comfort detects all the devices in the project as accessible, inaccessible and unknown devices, see "Going online (OBA8 only) (Page 44)" for more information.

See "Configuring settings for unknown devices (Page 156)" for more information about configuring unknown devices.

After the your device is found, you can stop displaying the online status for all devices. See "Going offline (OBA8 only) (Page 45)" for more information.

3.4.2.6 Configuring settings for unknown devices

You can configure the device name, IP address, subnet mask, and gateway of an unknown device to define it on the network.

Note

On normal occasions, you are able to delete the connection line between local PC and its connected device in the network view by choosing it and clicking the **X** button on the standard tool bar. But when deleting the unknown devices and their connection lines, you will need to disconnect them physically with the local PC, instead of deleting from the network view.

Uploading the added devices

To upload the added device to a project, right-click the device in the network view and select **Upload** from the shortcut menu. If no previous settings, the uploaded device can use the IP address, subnet mask, and gateway you defined in the step above. After completion, the device is displayed as an identified LOGO! Base Module.

Note

If the IP address of the uploaded device conflicts with the existing device, a warning message of IP address conflict pops out and then you need to reset its IP address according to "Configuring LOGO! online settings (Page 155)"

3.4.3 Ethernet connection configuration

3.4.3.1 Configuring Ethernet connection, LOGO! to local LOGO!

LOGO!Soft Comfort supports to create Ethernet connections in network view frame. For more information, you can refer to Tools -> Ethernet Connections (0BA7 and 0BA8 only) (Page 100).

Creating local connections through drag-and-drop

LOGO!Soft Comfort enables you to create Ethernet connections in the same LAN (Local Area Network) by dragging and dropping.

Simply click a connector of the source LOGO! Base Module, drag to the desired connector on the target LOGO! Base Module, and release the left button.

Result: LOGO!Soft Comfort connects the two connectors with a blue line. The currently-selected line is blue; both blue and green lines are configurable.

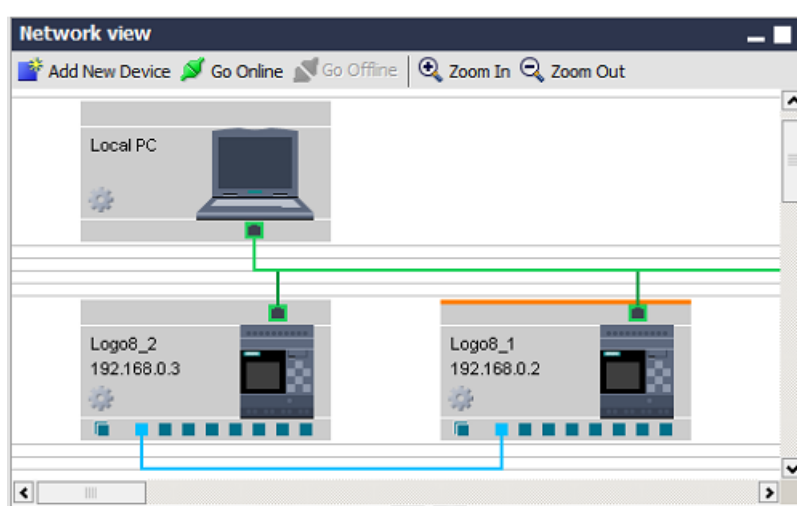

If you use the LOGO! Base Module as a dynamic server, LOGO!Soft Comfort supports to use drag-and-drop to create dynamic connections from the LOGO! Base Module to multiple client devices. LOGO!Soft Comfort automatically identifies the server and client according to your operations.

Double-click the connection line to configure the connection settings:

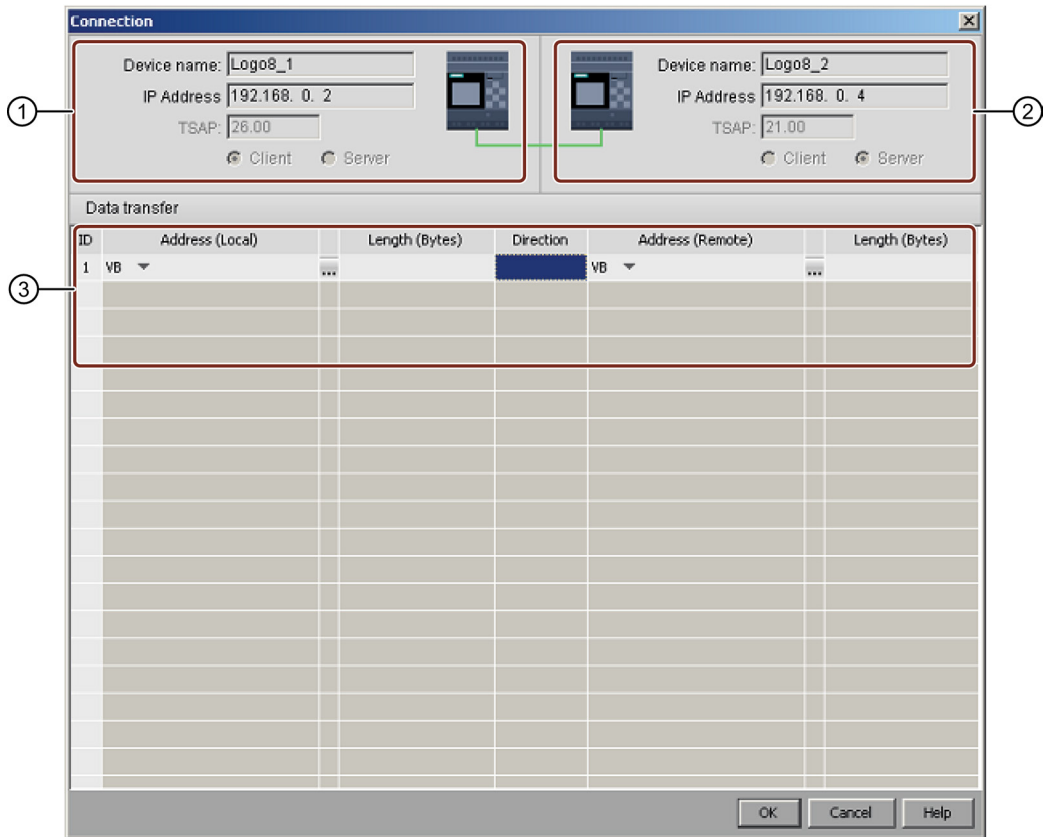

- ① **Starting point (Client):**
All the fields are read-only.
- ② **End point (Server):**
All the fields are read-only.
- ③ **Data transfer table**
See Tools -> Ethernet Connections (OBA7 and OBA8 only) (Page 100) for more information about data transfer configurations.

Note

If you connect a normal connector to a dynamic connector, the LOGO! device using the normal connector is the client.

Cross-LAN connection

LOGO!Soft Comfort allows to add devices with different LAN settings to the same network project.

If you attempt to connect devices outside the LAN, dragging and dropping approach may be inapplicable.

Make sure the router on both sides can communicate with each other, for information on how to create cross-LAN connections, see section Configuring Ethernet connection, LOGO! to non-project devices (Page 166).



Enabling the defined TSAP on the target device

LOGO! Base Module uses the TSAP (Transportation Service Access Point) as an identified label of the access point to any other devices.

The TSAP for the LOGO! physical connectors is from 20.00 to 27.00.

The TSAP for the LOGO! dynamic connector is from 00.01 to 18.FF.

You need to make sure the same TSAP is enabled on the target device in order to build data communication successfully.

Creating connections through cross-window operations (OBA8 only)

LOGO!Soft Comfort also supports the creation of Ethernet connections through configuring cross-window operations.

Simply click a connector of the source block, drag to the desired connector on the target block, and release the left button.

Results:

- LOGO!Soft Comfort connects the two connectors with a gray line, indicating that the line is read-only.
- LOGO!Soft Comfort adds a green NQ function block to the source LOGO! diagram, and a green NI function block to the target LOGO! diagram.

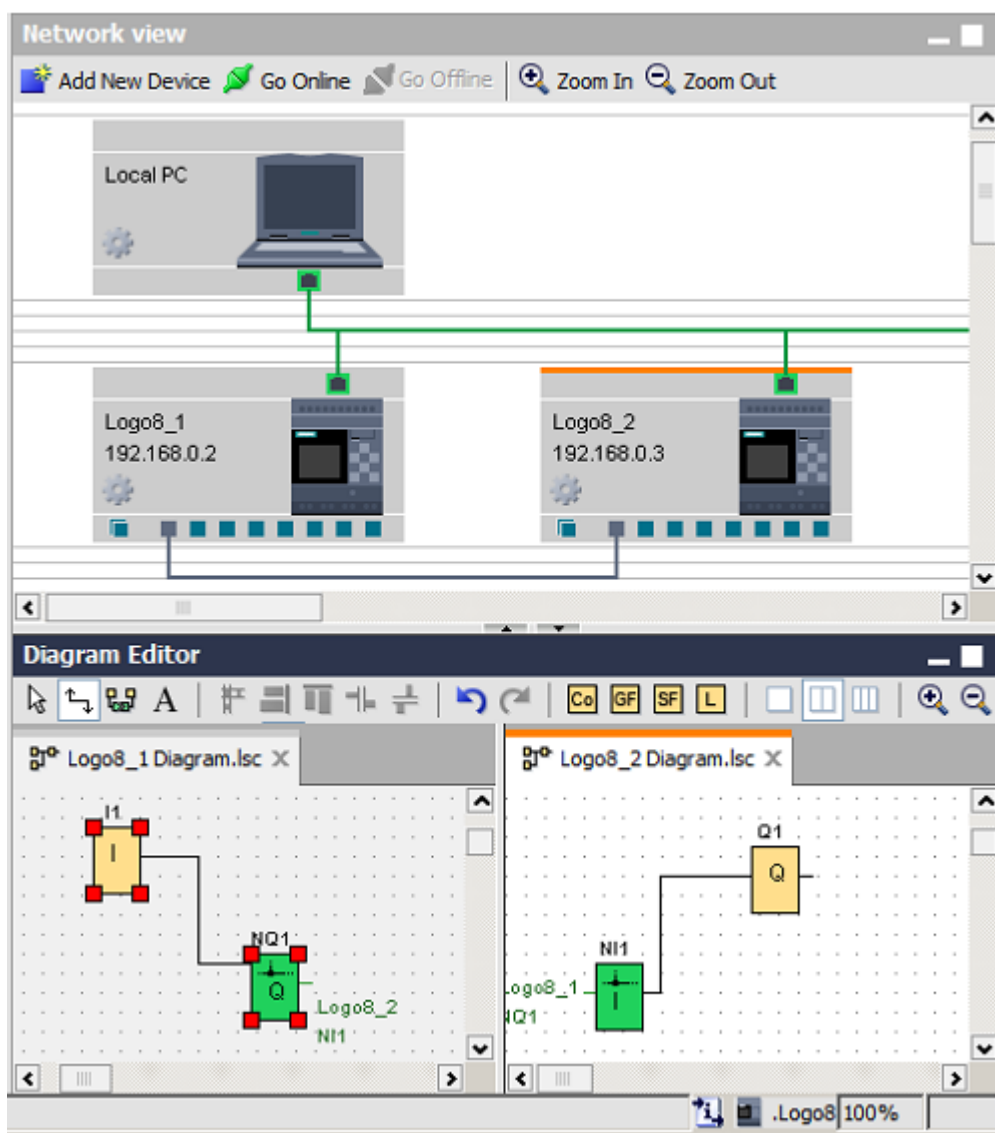

You need to know the following during your operations:

- LOGO!Soft Comfort creates connection lines in order from left to right.
- You can only change the server/client status, data transfer address, and direction by adding and configuring the related function block.
- You can only remove the connection line by deleting the added NI and NQ blocks. You cannot click **X** on the standard toolbar to remove these blocks.
- Once you remove one of the two automatically-added green function blocks, the other changes to red, warning that the connection is not complete.

3.4.3.2 Configuring Ethernet connection, LOGO! to remote devices

Creating remote connections

If you added network blocks to communicate with remote devices, you can configure connections as follows:

1. Right click the function block and set the block properties of this block.

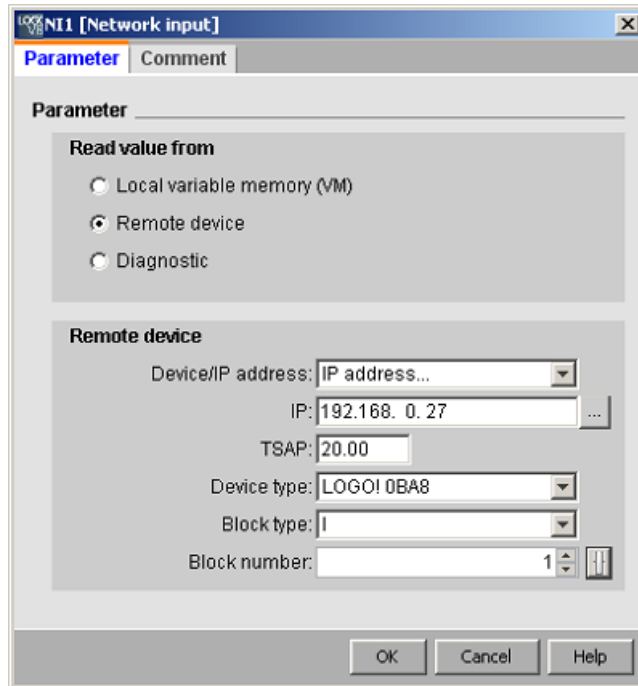

2. Define the device to connect as a remote device.
3. Choose the device name and IP address of the target device. Alternatively, you can also browse for a device configured previously.

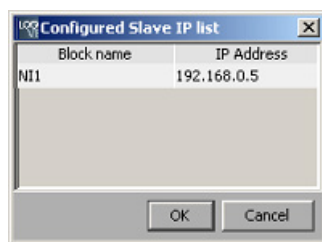

LOGO!Soft Comfort supports to configure your local device to the following remote devices on the listed block types and their value range.

For NI and NAI:

Function Block	Local Device	Remote Device	Block Type and Value Range
NI	LOGO! 0BA8	LOGO! 0BA8	I: [1, 24] / Q: [1, 20] / M: [1, 64] / V: [0, 850].[0,7]
		LOGO! 0BA7	I: [1, 24] / Q: [1, 16] / M: [1, 27] / V: [0, 850].[0,7]
		S7 Compatible device	I: [0, 65535].[0,7] / Q: [0, 65535].[0,7] / M: [0, 65535].[0,7] / V: [0, 65535].[0,7] / DB: [0, 16000].[0, 65535].[0,7]
		LOGO! 0BA8 Slave	I: [1, 24] / Q: [1, 20]
		LOGO! 0BA7 Slave	I: [1, 24] / Q: [1, 16]
	LOGO! 0BA7	LOGO! 0BA7 Slave	I: [1, 24] / Q: [1, 16]
NAI	LOGO! 0BA8	LOGO! 0BA8	V: [0, 849]
		LOGO! 0BA7	V: [0, 849]
		S7 Compatible device	I: [0, 65534] / Q: [0, 65534] / M: [0, 65534] / V: [0, 65534] / DB: [0, 16000].[0, 65534]
		LOGO! 0BA8 Slave	AI: [1, 8] / AQ: [1, 8]
		LOGO! 0BA7 Slave	AI: [1, 8] / AQ: [1, 2]
	LOGO! 0BA7	LOGO! 0BA7 Slave	AI: [1, 8] / AQ: [1, 2]

For NQ and NAQ:

Function Block	Local Device	Remote Device	Block Type and Value Range
NQ	LOGO! 0BA8	LOGO! 0BA8	I: [1, 24] / Q: [1, 20] / M: [1, 64] / V: [0, 850].[0,7]
		LOGO! 0BA7	V: [0, 850].[0,7]
		S7 Compatible device	I: [0, 65535].[0,7] / Q: [0, 65535].[0,7] / M: [0, 65535].[0,7] / V: [0, 65535].[0,7] / DB: [0, 16000].[0, 65535].[0,7]
		LOGO! 0BA8 Slave	Q: [1, 20]
		LOGO! 0BA7 Slave	Q: [1, 16]
	LOGO! 0BA7	LOGO! 0BA7 Slave	Q: [1, 16]
NAQ	LOGO! 0BA8	LOGO! 0BA8	V: [0, 849]
		LOGO! 0BA7	V: [0, 849]
		S7 Compatible device	I: [0, 65534] / Q: [0, 65534] / M: [0, 65534] / V: [0, 65534] / DB: [0, 16000].[0, 65534]
		LOGO! 0BA8 Slave	AQ: [1, 8]
		LOGO! 0BA7 Slave	AQ: [1, 2]
	LOGO! 0BA7	LOGO! 0BA7 Slave	AQ: [1, 2]

Configuring remote connections

Follow the same approach to configure remote connections as that in section Configuring Ethernet connection, LOGO! to local LOGO! (Page 157). Note that LOGO!Soft Comfort allows you to switch to the diagram of the connected device simply by clicking on the values (NI1/NQ1...) in the connection dialog. This operation is only available for network blocks.

3.4.3.3 Configuring Ethernet connection, LOGO! to LOGO! slave

LOGO!Soft Comfort supports the connection of a LOGO! Base Module to a LOGO! slave only through network blocks.

Switch the target device to slave mode. Refer to Tools -> Transfer -> Configure Master/Slave Mode (0BA7 and 0BA8 only) (Page 79) for details.

Follow the same steps as Configuring Ethernet connection, LOGO! to remote devices (Page 161).

Choose the target device and LOGO!Soft Comfort automatically changes the device type to slave.

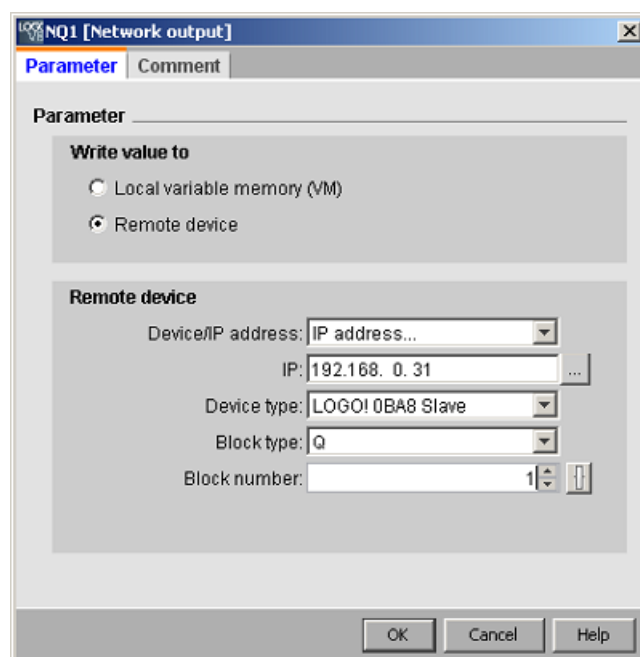

Note

You can only create connections between a LOGO! Base Module and its client using network function blocks (NI/NQ/NAI/NAQ). Drag-and-drop operations are not available in this case.

Note

LOGO! 0BA8 supports 24 NIs and 20 NQs separately. But no matter NI or NQ, you can have maximum 32 data connections in total.

3.4.3.4 Configuring Ethernet connection, LOGO! to S7 devices

LOGO!Soft Comfort supports the creation and configuration of Ethernet connections between LOGO! Base Modules and S7 compatible devices.

Double-click the connection line to configure the connection settings:

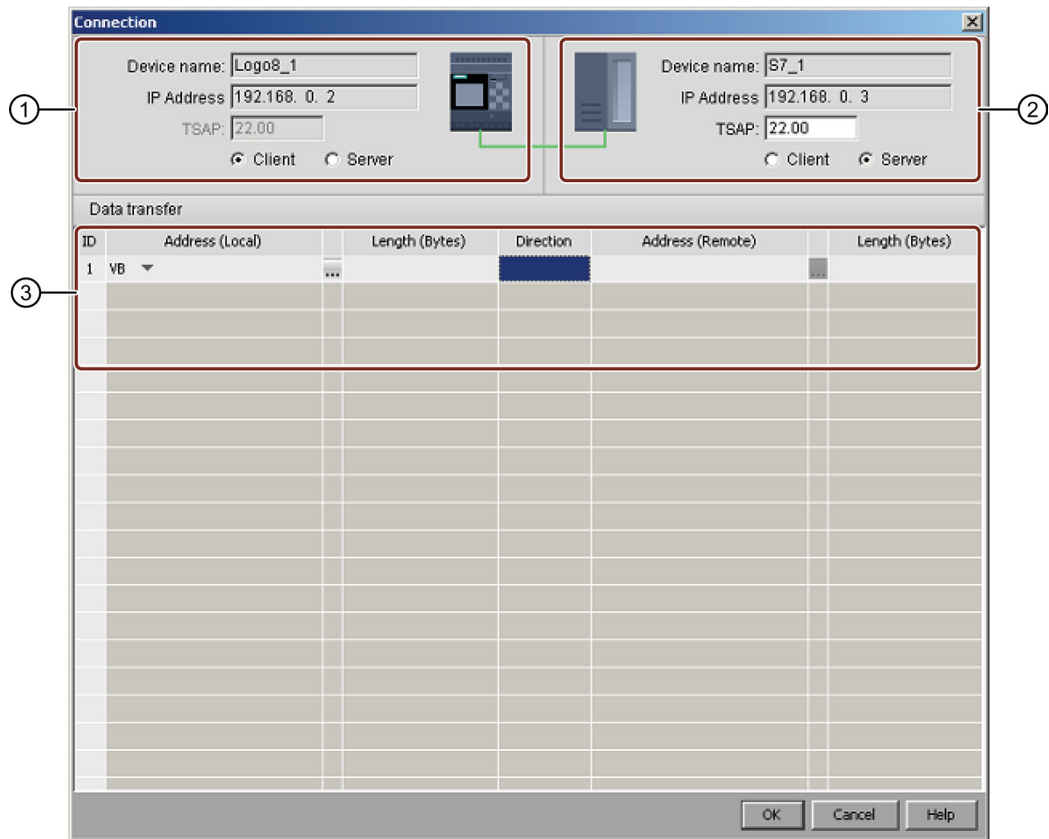

- ① **LOGO! Base Module:**
The LOGO Base Module is the client by default, you can set it as the client or the server here.
- ② **S7 Device:**
The S7 device is the server by default, you can set it as the server or the client here.
- ③ **Data transfer table**
See Tools -> Ethernet Connections (OBA7 and OBA8 only) (Page 100) for more information about data transfer configurations.

Note

If you connect the dynamic connector with an S7 compatible device, LOGO!Soft Comfort disables the server/client check boxes. The LOGO! Base Module with the dynamic connector is always the server in this connection.

3.4.3.5 Configuring Ethernet connection, LOGO! to HMI devices

LOGO!Soft Comfort supports the creation and configuration of Ethernet connections between LOGO! Base Modules and Siemens HMI (SIMATIC Panel) devices.

Double-click the connection line to configure the connection settings:

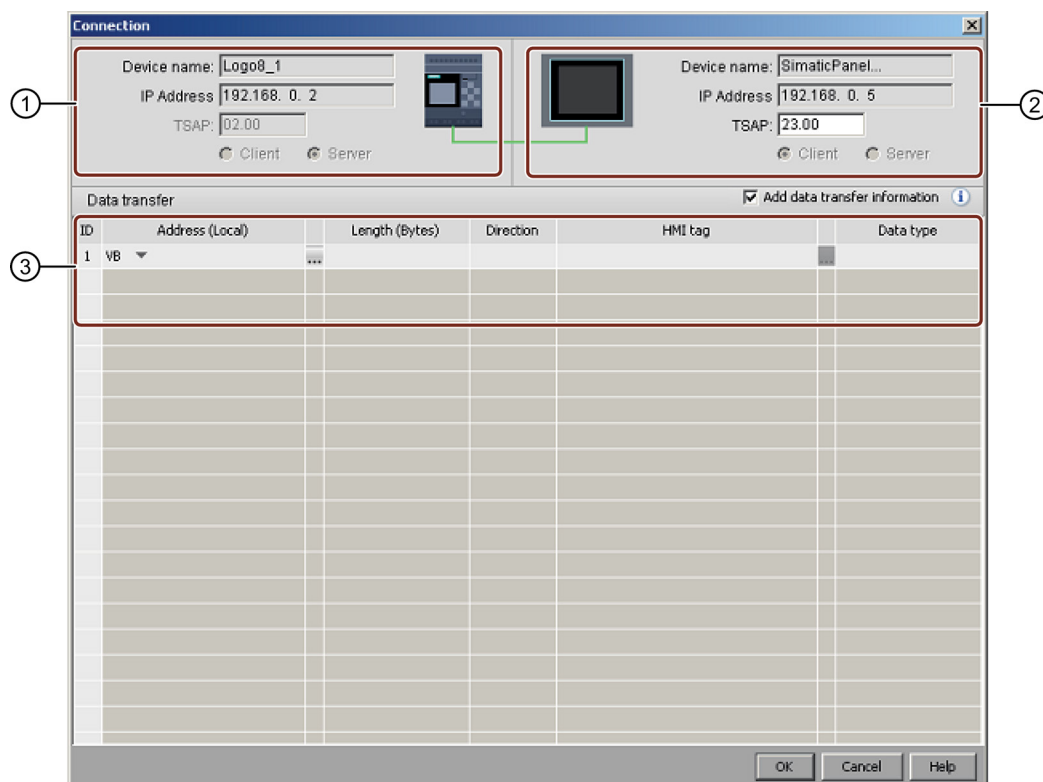

- ① **LOGO! Base Module:**
All the fields are read-only.
The LOGO! Base Module is always the server.
- ② **HMI:**
You can set the TSAP address here. Or it shows the TSAP of the starting point of your connection.
- ③ **Data transfer table**
Select the "Add data transfer information" check box to activate the data transfer table.
See Tools -> Ethernet Connections (0BA7 and 0BA8 only) (Page 100) for more information about data transfer configurations.

Note

The LOGO! Base Module is always the server in a connection between a LOGO! Base Module and an HMI device. A LOGO! device can only connect to one HMI.

3.4.3.6 Configuring Ethernet connection, LOGO! to non-project devices

LOGO!Soft Comfort supports the creation and configuration of Ethernet connections between LOGO! Base Modules and devices outside of the current project.

You can right-click the LOGO! Base Module or its connector and choose to add a server connection or a client connection.

Adding server connection

Follow the steps below to configure the server connection.

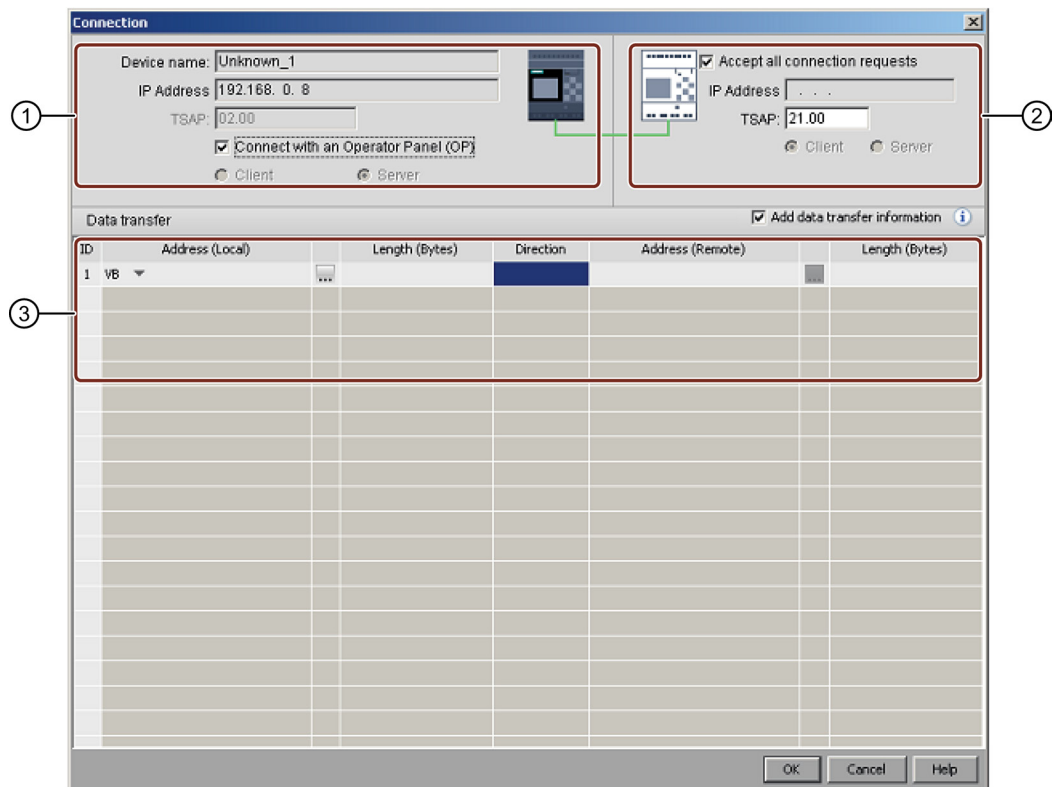

① **LOGO! Base Module:**

Here you can set if you are trying to connect to an operator panel like SIMATIC Panel.

② **Non-project Device:**

Here you can set whether to allow access from all requests, or enter the IP address and TSAP port to enable connection to the non-project device.

You must allow access from all requests if you are trying to connect to devices outside of the LAN (Local Area Network).

③ **Data transfer table**

Use the check box to activate the data transfer table.

See Tools -> Ethernet Connections (0BA7 and 0BA8 only) (Page 100) for more information about data transfer configurations.

Adding client connection

Follow the steps below to configure the client connection.

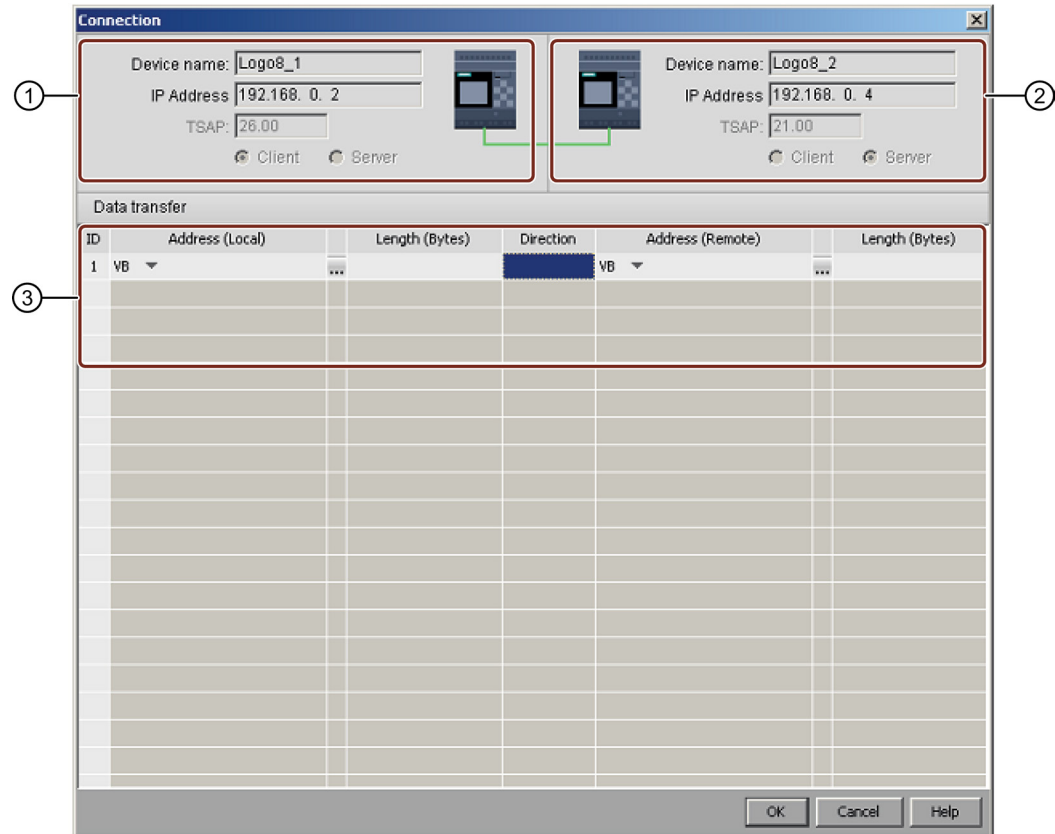

- ① **LOGO! Base Module:**
All the fields are read-only.
- ② **Non-project Device:**
Enter the IP address and TSAP port to enable connection to the non-project device.
- ③ **Data transfer table**
See Tools -> Ethernet Connections (0BA7 and 0BA8 only) (Page 100) for more information about data transfer configurations.

Connection result

LOGO!Soft Comfort displays the connection as a terminal in the network view.

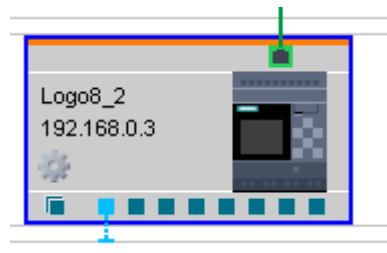

Note

- If you choose the LOGO! Base Module when creating connections, the terminal automatically uses the available connector in the left-to-right order.
 - If you choose a specific connector, the terminal uses the connector that you selected.
-

3.5 Practical example

3.5.1 Practical example: Introduction

This practical sample application (Page 168) for a service water pump offers new users a step-by-step introduction. You learn here how to apply the functions that you have learned, based on a practical example.

Further samples of circuit programs are found in the Sample Applications section (Page 181).

3.5.2 The task

In addition to the drinking water supply, rainwater takes an increasing part in domestic water supply systems, thus saving money and helping to protect the environment. For example, rainwater can be used for the following needs:

- Washing clothes
- Watering the garden
- Watering indoor plants
- Washing the car
- Flushing the toilet

Rainwater can be collected in a suitable system to be used instead of drinking water.

Description of the system

The rainwater is collected in a reservoir. From the reservoir, it is pumped into a respective water supply system. From there it can be tapped in the same way as drinking water. The system functions can be upheld by supplying drinking water if the reservoir runs out of service water. Service water may include water for various services - washing, bathing, cooking, watering plants, etc.

The goal of this task is to create a control circuit that satisfies the requirements for such an installation.

The sketch below illustrates how such a service water system works:

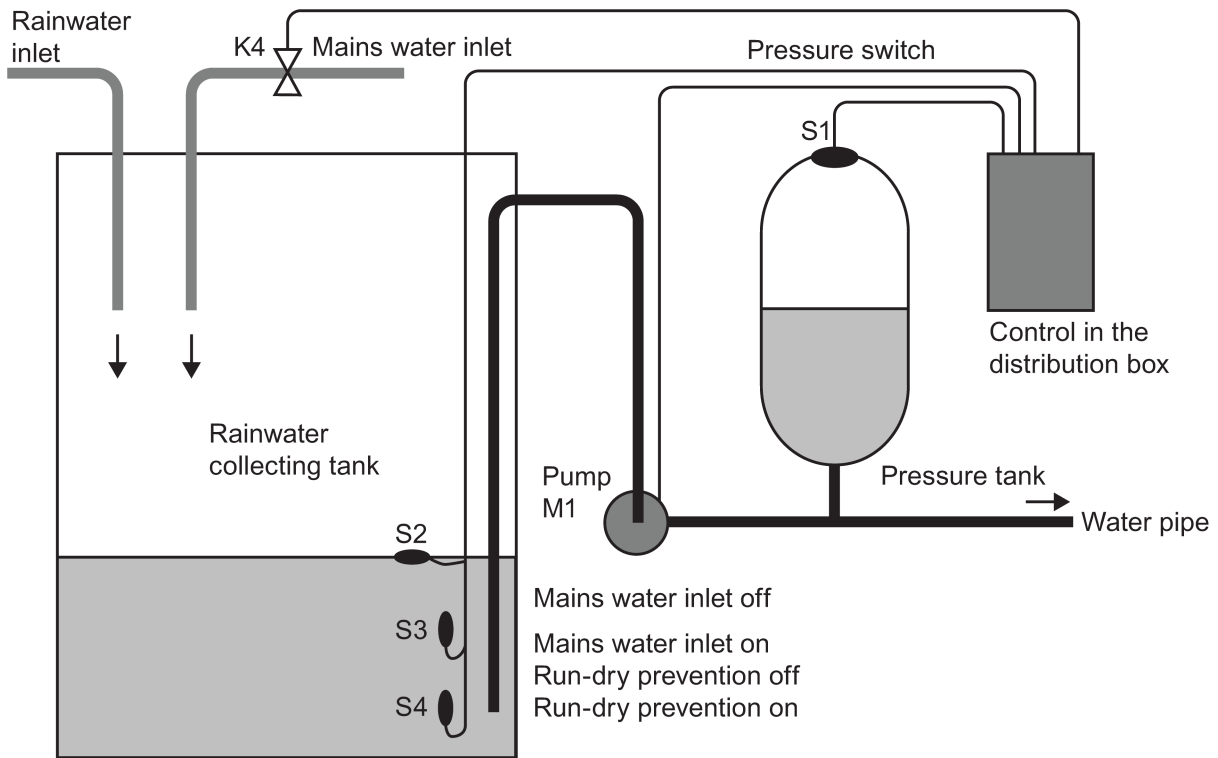

Requirements of the control system

- Service water must be available at all times. An emergency control system must change over to drinking water supply, for example, if service water runs low.
- The ingress of service water into the drinking water network must be prevented when switching over to drinking water supply.
- The pump must be disabled if the service water reservoir runs low of water (dry-run protection).

3.5.3 Layout of the solution

The pump and a solenoid valve are controlled by a pressure switch and three float switches, which are installed in the service water reservoir. The pump must be switched on if the pressure in the reservoir drops below minimum. When the operating pressure is reached, the pump is switched off again after a tracking time of a few seconds. The tracking time prevents pump oscillation if water is tapped over an extended period.

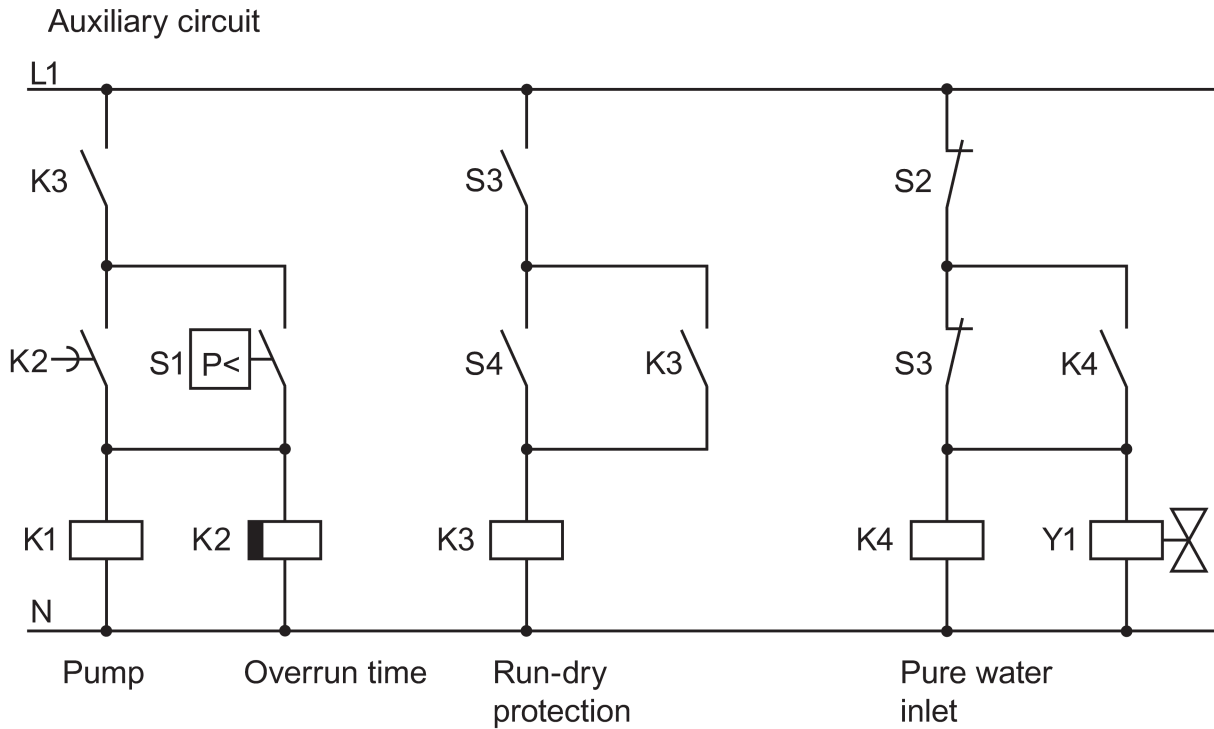

3.5.4 Solution with LOGO!

Connecting field devices

In addition to the LOGO! device, all you need is the pressure switch and the float switches to control the pump. If you are using a 3-phase AC motor, a contactor relay is required for switching the pump. In systems with single-phase AC pumps, you must install a contactor relay if the current of the AC pump exceeds the switching capacity of the output relay Q1. A solenoid valve can usually be controlled directly, due to its low power consumption.

Connection diagram

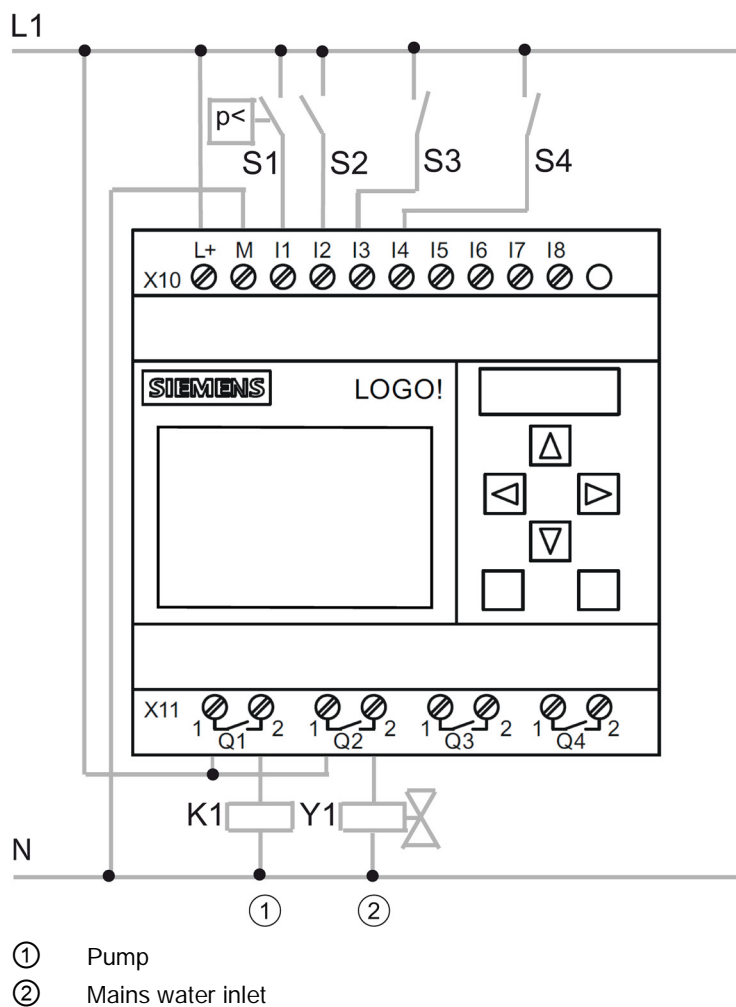

Block diagram

The block diagram shows you how to interconnect the pump controls and the solenoid valve. The layout corresponds with the structure of the circuit program.

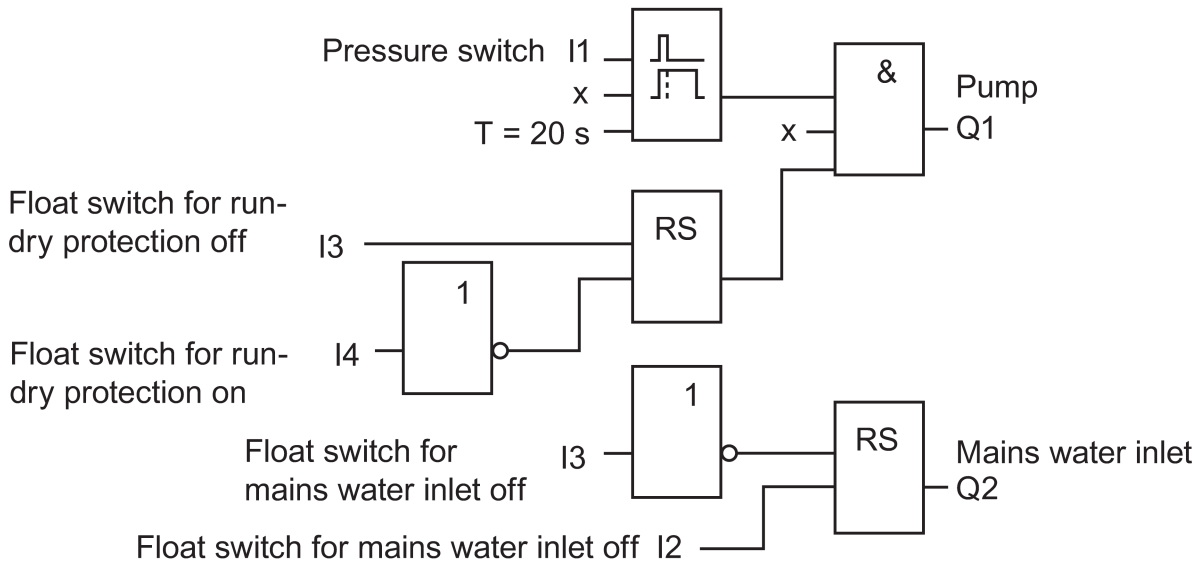

Options

For specific applications, you also have the choice of integrating additional functions which could otherwise only be realized with additional switchgear:

- Enabling the pump at specific times, for example, only during the summer months or at a specific time-of-day
- Indication of an imminent or existing shortage of water
- System error messages

3.5.5 Input of project data

After you have planned your project, you can start to create it in LOGO!Soft Comfort. If you do not want to start programming right away, you can first input your project data in the Properties dialog (Page 54).

When working through the following steps, remember to save your circuit program at regular intervals. You might want to open a revised version at a later time to test out other options.

3.5.6 Placing blocks

In the next step, place the required blocks into the programming interface. Note that in addition to the standard and special functions, you also require I/O blocks. At this stage of progress it is sufficient for you to place the blocks roughly into position that seems appropriate to you for connecting them later. You can carry out fine positioning after making all of the connections.

FBD Editor:

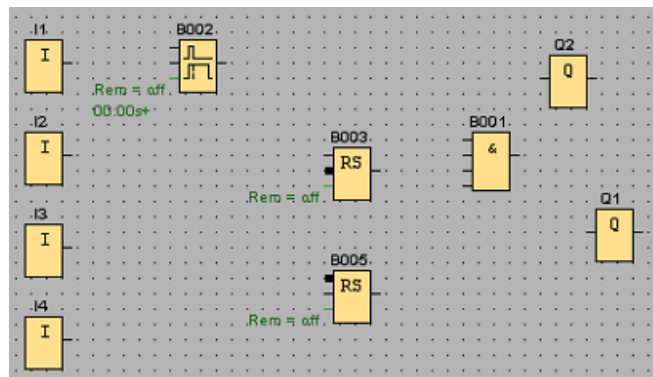

LAD Editor:

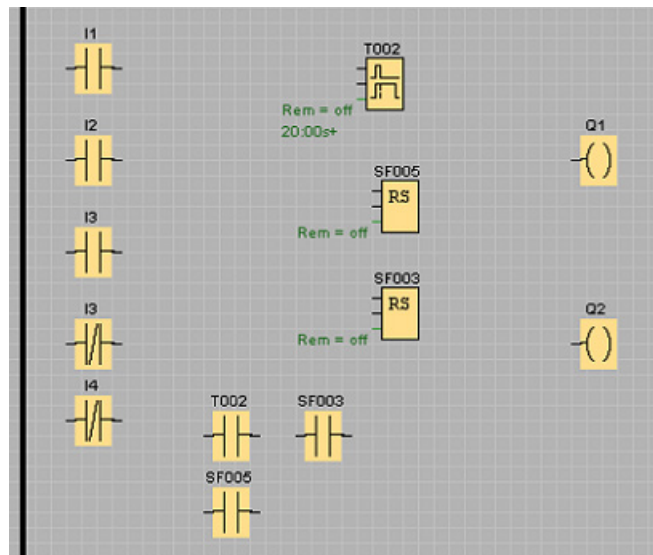

UDF Editor:

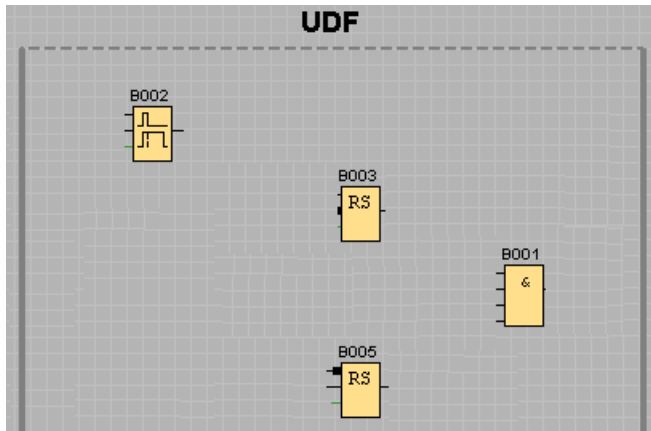

3.5.7 Connecting blocks

Connect the blocks as you have planned previously. Connect them by drawing the connecting line, starting at the output of a source block and ending at the input of the target block. This has the advantage that you are shown the name of the connector when you interconnect the input, which is particularly advantageous for the various connectors of SFBs.

FBD Editor:

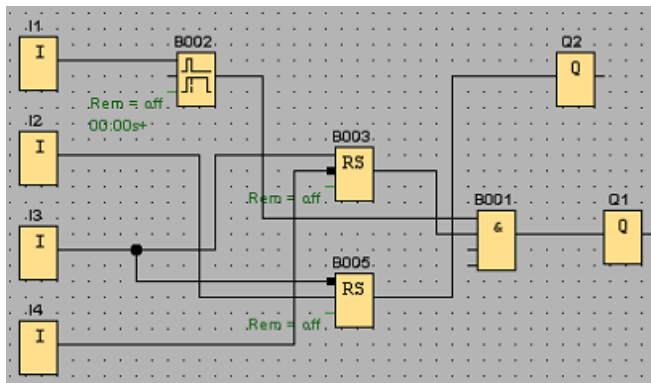

LAD Editor:

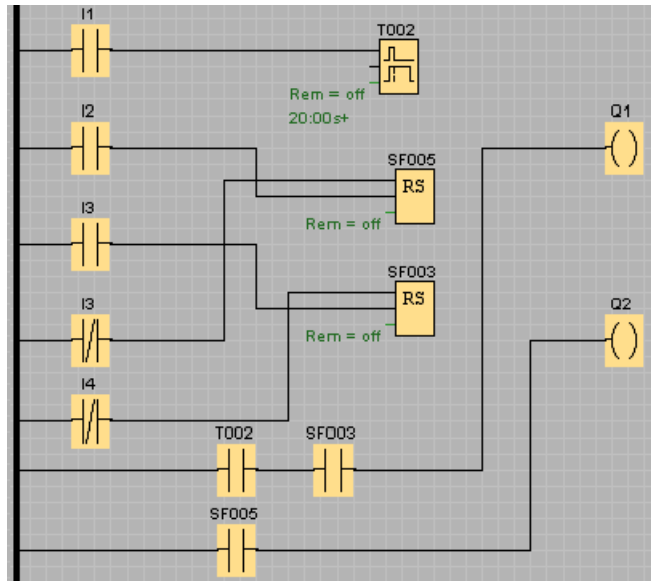

UDF Editor

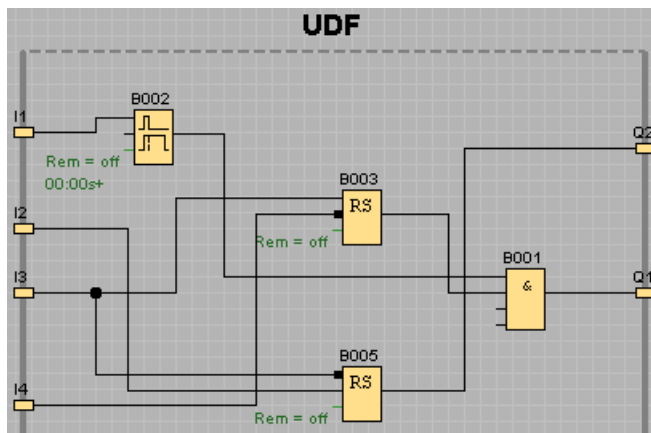

3.5.8 Cleaning up the programming interface

Some of the connecting lines might be routed across blocks, which can make the layout of the circuit program hard to read. To "tidy up" the programming interface, select the connecting lines and blocks where required and move or align them until you have optimized the circuit program layout as far as possible.

FBD Editor:

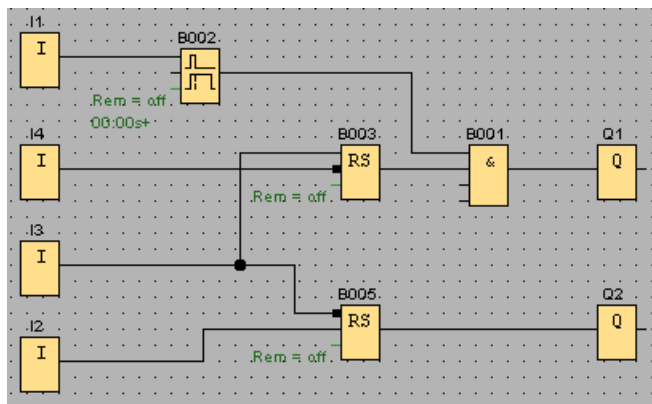

LAD Editor:

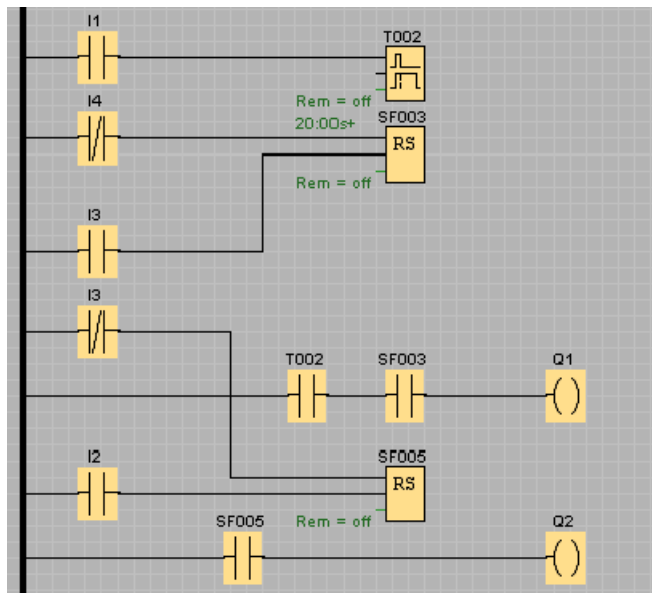

UDF Editor

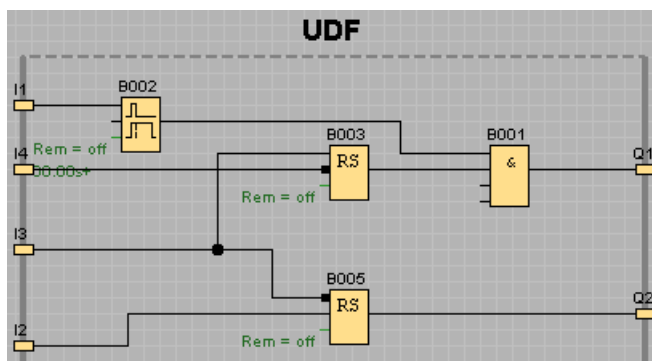

3.5.9 Optimizing the view

You can cut unwanted though unavoidable line crossings using the Cut/Join tool (Page 39) to improve the appearance.

FBD Editor:

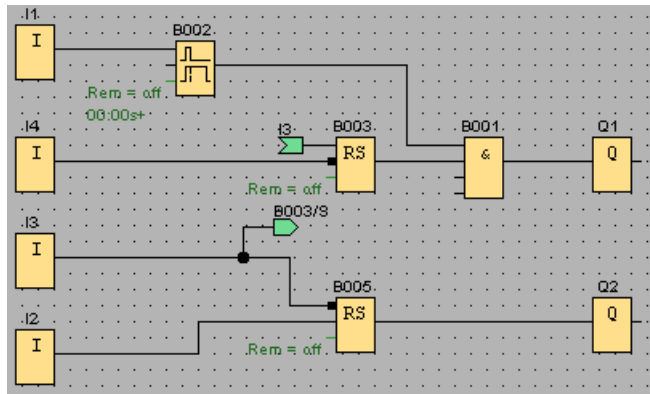

LAD Editor:

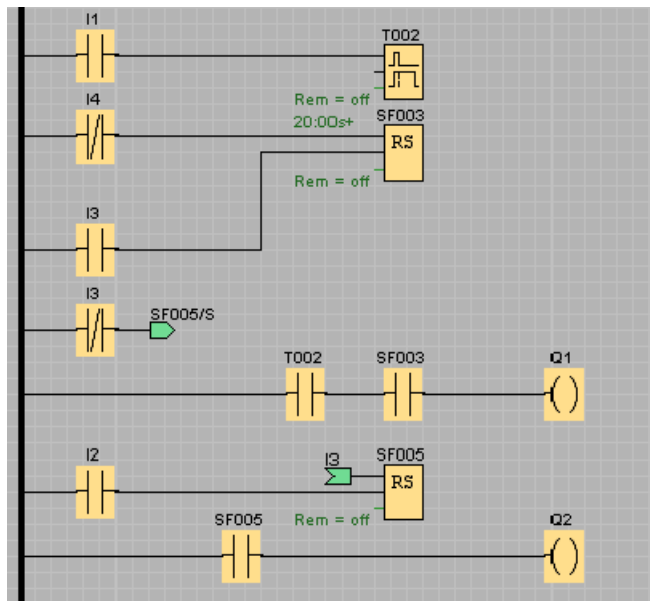

UDF Editor

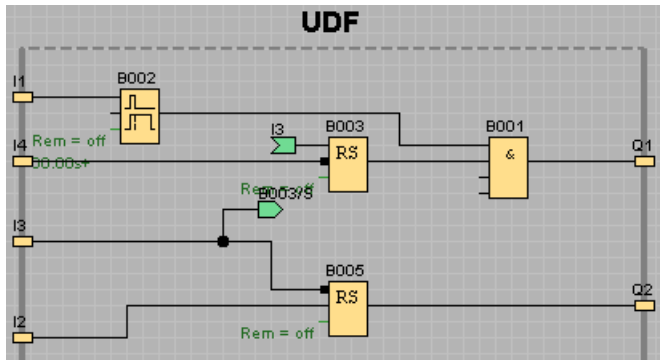

Note that UDF blocks do not support inputs, outputs, analog inputs, analog outputs, M8, M25, M26, M27, shift registers, the data log or message text function blocks.

You have now completed your circuit program. Verify all connections once again and configure the block parameters to suit your requirements.

3.5.10 Testing the circuit program

Place your circuit program in simulation mode (Page 95) and verify that your program is error-free.

Although you now know that you can run your circuit program in LOGO!, you still need to make sure your circuit program operates as planned. You may also want to modify certain parameters. You can try out different input values, test the reaction of the system to power failure and compare your calculations or expectations with the simulated reaction of the outputs. The simulation toolbar and status window (Page 35) provide the tools you need for these tasks.

The float and pressure switches have a momentary action. If, however, you wish to simulate your circuit for testing purposes, simply change the input function from momentary action to switching action.

Example for the FBD Editor:

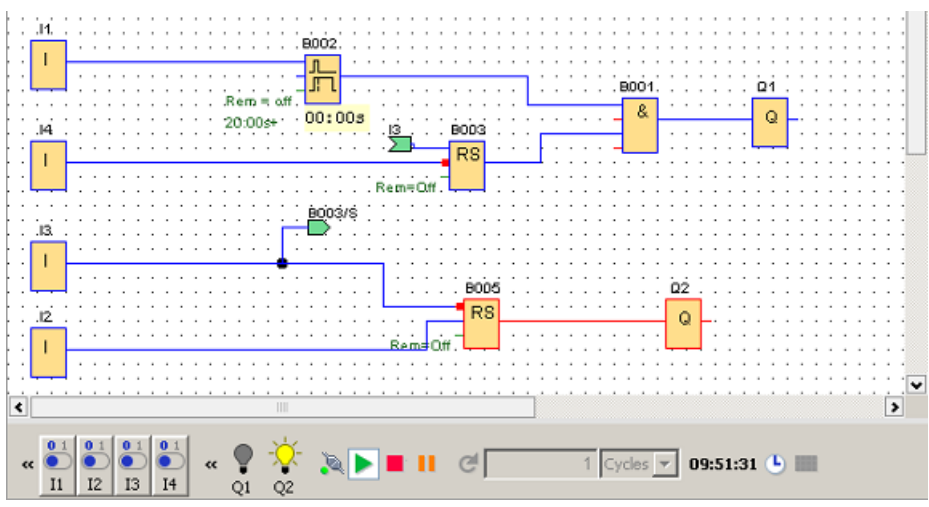

When you have made all corrections and everything runs as expected, you can start to document your circuit program.

3.5.11 Circuit program documentation

Program comments

You can now start to add comments to your program using the Text tool (Page 39). Describe the I/O to make your circuit program easy to understand. You do not have to display the connector names on-screen. You should nevertheless assign names to the connectors, because you may want to print out a connection list at a later time. From the comment tab of the File → Properties dialog (Page 53), you can add a comment to your circuit program, which you can include when you print the circuit program.

Example for the FBD Editor:

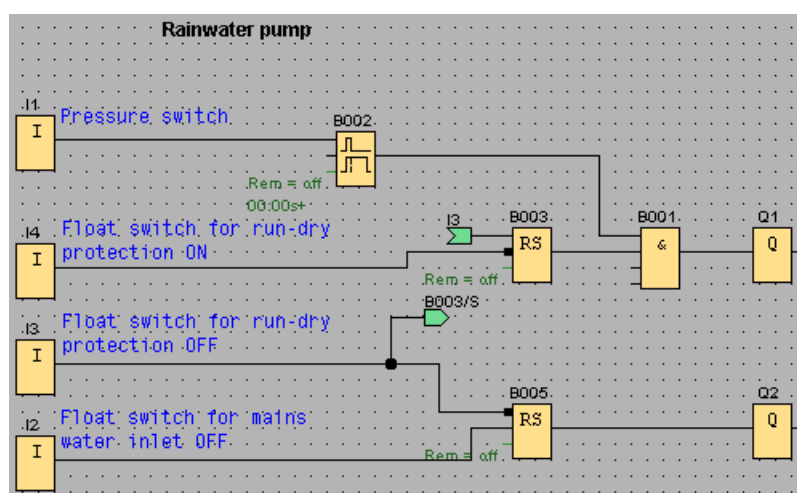

Saving the file to a storage medium

Before you transfer your circuit program, you should save it once again. Choose the relevant command from the menu and enter a program name and path.

Printing the circuit program

Use the File → Print (Page 51) command to print a copy of your circuit program. From this dialog you specify the print format and the details to be included or omitted.

3.5.12 Transferring the circuit program

Password protection

To protect your process solution and prevent unauthorized access to your circuit program, you can assign a password before you transfer it to LOGO!.

To assign this password, use the Parameter tab of the File → Properties (Page 53) menu command dialog. Enter your password and confirm it with OK.

Password protection is used when you transfer the circuit program to LOGO! and is activated when LOGO! exits transfer mode.

The password protects your circuit program in LOGO!. Editing values and parameters, or viewing the circuit program in LOGO!, or uploading the circuit program from LOGO! to the PC is now only possible after you have entered the password.

Transferring the circuit program

Finally, transfer your circuit program to a suitable LOGO! version and then connect the module. Connect LOGO! with the consumer devices in your project.



You have created the circuit program under LOGO!Soft Comfort within a very short time and, compared with conventional methods, you have saved yourself a considerable amount of time and effort.

3.5.13 Performing an online test of the circuit program

After you are satisfied with your program simulation and have downloaded it to LOGO! Base Module, you can also perform an online test of the circuit program. An online test is similar to simulation in that you can view inputs and outputs and block parameters. It differs, however, in that you are testing the program running in the LOGO! Base Module with "live" inputs rather than testing the program on the PC with simulated inputs.

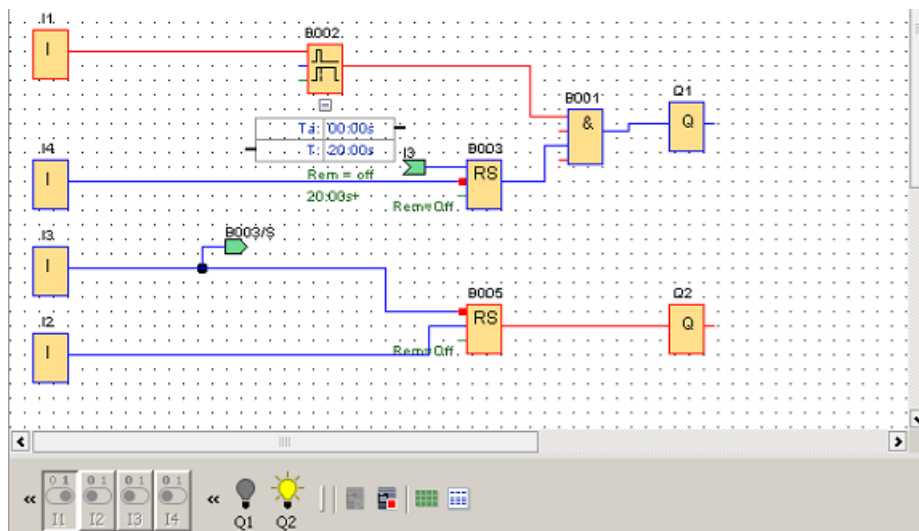
The following example shows an online test of the practical example circuit program. In this example, input I1 was turned on and then turned off. The off-delay timer began counting when I1 was turned off:



	Synchronize message text
	Data Table

See the topic Simulating network communication (0BA7 and 0BA8 only) (Page 147) for prerequisite conditions for an online test.

During an online test, you can modify a parameter of a function block with the LOGO!Soft Comfort. After your modification, the LOGO! Base Module then synchronizes the modified parameter. You can also modify the parameter in the LOGO! Base Module, and the LOGO!Soft comfort synchronizes the modified parameter.

Note

If the LOGO! Base Module is still in "Set Param" mode, it can not synchronize your modification in the LOGO!Soft Comfort.

Sample applications

Introduction

To give you an impression of the versatility of LOGO!, LOGO!Soft Comfort includes a small collection of applications, in addition to the service water pump application shown in the tutorial.

This online help briefly describes the tasks and presents the relevant solutions with LOGO!Soft Comfort. You can find these circuit programs, as well as many others, on your LOGO!Soft Comfort DVD-ROM in the ..\Samples folder. You will also find there documentation for the various samples.

Additional sample programs are also available on the Internet at <http://www.siemens.com/logo-application-examples>.

Note

LOGO! sample applications are available and free of charge to our customers. We provide the sample applications without guarantee, and they are intended for general information about the possible fields of application for LOGO! Base Modules and LOGO!Soft Comfort software. Custom solutions may be different.

The user operates the system at his own responsibility. We also refer to local standards and system-related installation regulations.

This section presents the following sample applications:

- Air-conditioning system (Page 181)
- Factory door (Page 183)
- Heating control (Page 184)
- Fill station (Page 187)

Note the service water pump example (Page 168).

4.1 Air-conditioning system

Requirements for an air-conditioning system

An air-conditioning system supplies fresh air into a room and exhausts the contaminated air. Let us look at the following sample system:

- A room contains an extractor fan and a fresh-air fan.
- Each fan under monitoring by means of a flow sensor.
- The pressure in the room may rise above the atmospheric pressure.

4.1 Air-conditioning system

- The fresh-air fan may only be switched on if the flow sensor signals the safe operational state of the extractor fan.
- A warning lamp indicates failure of one of the fans.

Standard solution

The fans are under monitoring by means of flow sensors. If the sensors registered no air flow after a short delay time has expired, the system is switched off and an error message is generated, which can be acknowledged by pressing the off button.

Fan monitoring requires an analyzer circuit with several switching devices, in addition to the flow sensors. A single LOGO! device can replace this analyzer circuit.

LOGO!Soft Comfort solution

The use of LOGO! reduces the amount of switchgear. Thus, you save installation time and space in the control cabinet. You may even be able to use as a smaller control cabinet.

With LOGO! you can also switch off the fans sequentially after the system is switched off.

The circuit in LOGO!Soft Comfort

The system is switched on and off at the inputs I1 and I2. The fans are connected to outputs Q1 and Q2, the flow sensors are connected to the inputs I3 and I4. Blocks B007 and B008 are used to set the watchdog times after which the flow sensors should send a signal to the fault output Q3.

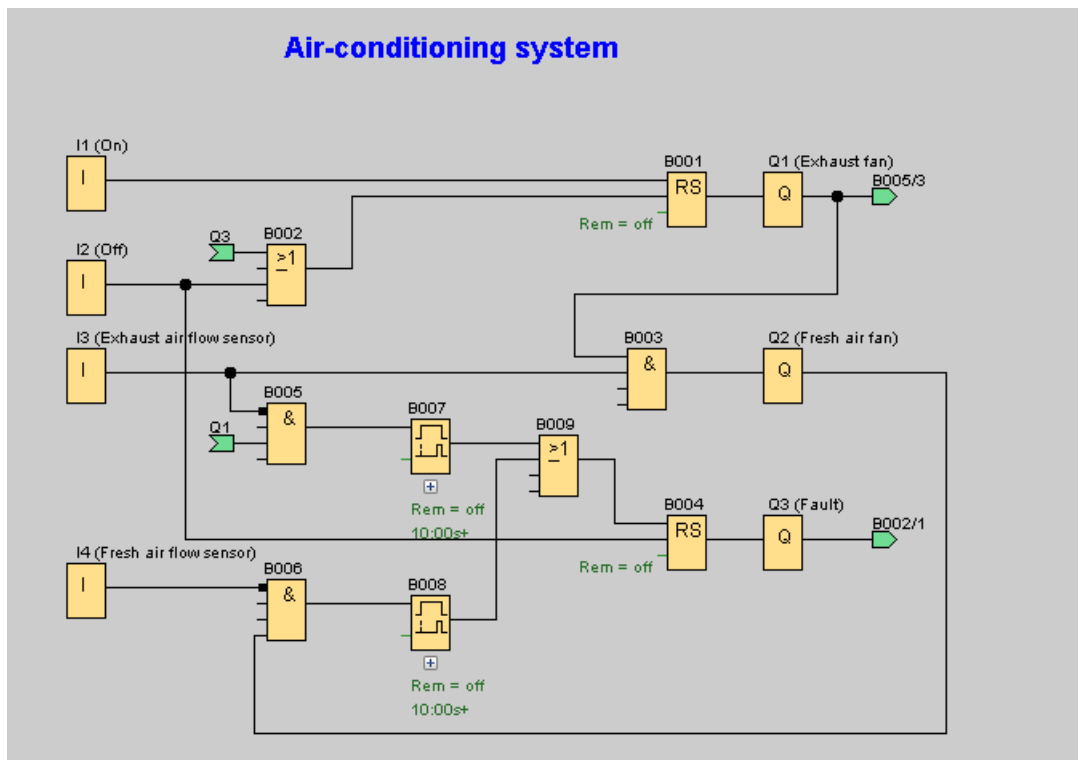

You can invert output Q3 to use output messages at Q4. Relay Q4 only drops out if main power is lost or if there is a fault in the system. The output can then be used for a remote message.

4.2 Factory door

Requirements for a gate control system

In many cases a factory entrance is closed with roll gates. Those gates are only opened when vehicles need to enter or leave the factory grounds. The gate is controlled by a gatekeeper.

- The sliding gate is opened and closed by means of a pushbutton control in the gatehouse. The gatekeeper can monitor the gate operation.
- The roll gate is normally fully opened or it is closed. However, gate movements can always be interrupted.
- A flashing light is activated five seconds before the gate moves and while the gate is in motion.
- A safety pressure strip ensures that people are not injured and that no objects are trapped and damaged when the gate is closing.

Standard solution

There are many different control systems for operating automatic gates. The OPEN and CLOSE buttons initiate gate movements in the relevant direction, provided it is not already moving in the opposite direction. Movement of the gate is terminated either by means of the STOP button or the relevant limit switch.

LOGO!Soft Comfort solution

A LOGO! circuit provides a further feature compared to standard controls: The actuation of a safety bar interrupts the closing motion of the gate. Five seconds before the gate opens or closes, a flashing light is activated and signals the start of the movement. It continues flashing until the gate has stopped.

In contrast to standard solutions, LOGO! offers an easy and economic means of modifying the control system.

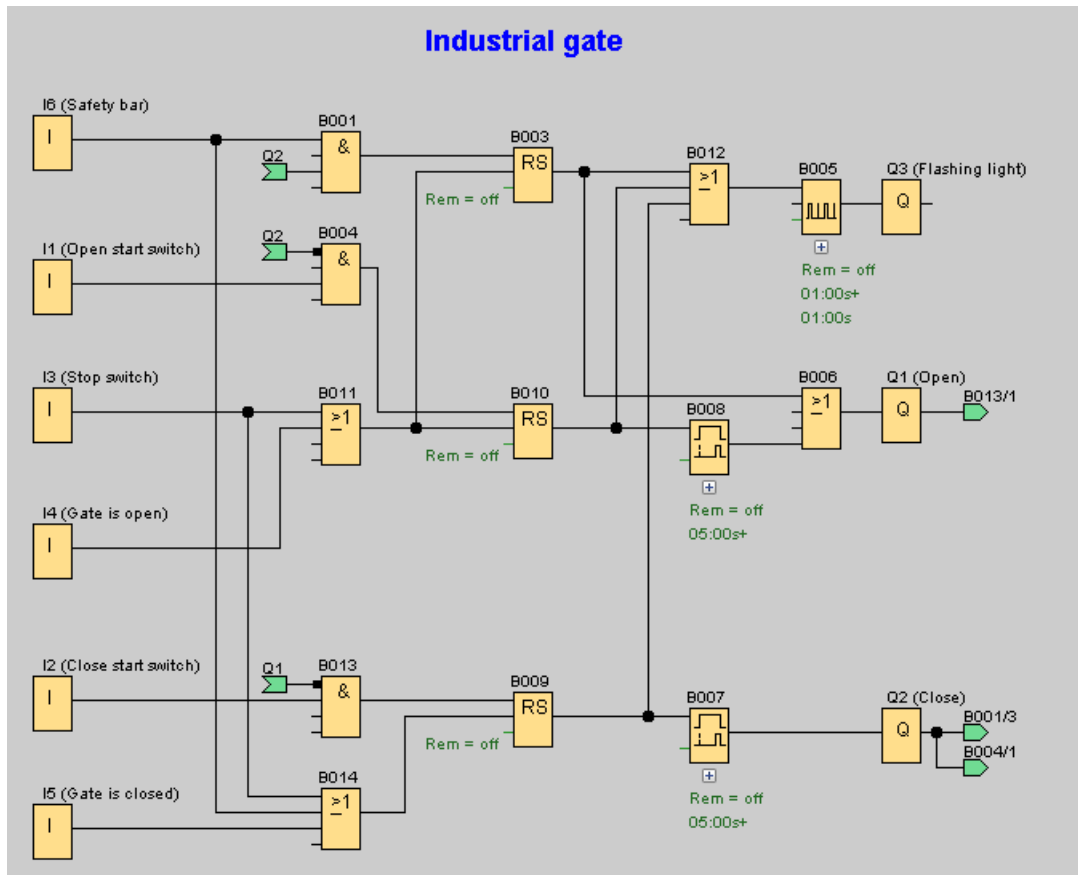

4.3 Heating control

Requirements of the heating control

This example illustrates a heating control where the flow temperature of the heating is to be controlled at an inverse proportion to the outdoor temperature. This means that the lower the outdoor temperature, the greater the flow temperature.

PT100 sensors measure the outdoor and flow temperatures.

With an outdoor temperature of 0 °C, the flow temperature should be 50 °C (x).

If the outdoor temperature drops by more than 4 °C, the heating should switch on.

LOGO!Soft Comfort Solution

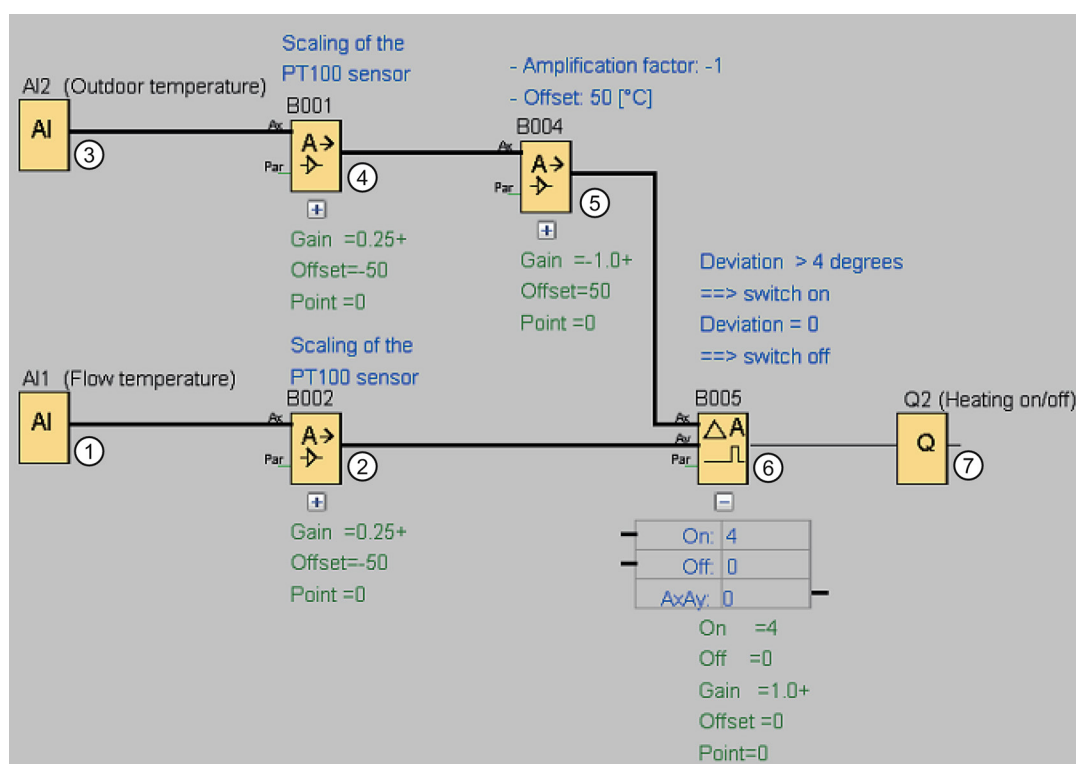

① A PT100 sensor is connected to AI1 which measures the flow temperature.

② The parameters for the analog amplifier are as follows:

- Sensor: PT100
- The PT100 sensors stipulate the measuring range and parameters.
- Unit: Celsius
- Resolution: x 1

The amplifier causes the actual temperature that the sensor has measured to be issued as the output.

③ A PT100 sensor is connected to AI2 which measures the outdoor temperature.

④ The parameters for the analog amplifier are as follows:

- Sensor: PT100
- The PT100 sensors stipulate the measuring range and parameters.
- Unit: Celsius
- Resolution: x 1

The amplifier causes the actual temperature that the sensor has measured to be issued as the output.

⑤ The parameters for the analog amplifier are as follows:

- Sensor: No sensor
- Gain: -1 (changes the sign of the value of the analog amplifier output from B001)
- Offset: 50

The parameters of the amplifier at B004 cause the difference of the compared temperatures of the comparator at B005 to be 0 if the sum of both temperatures is 50.

⑥ The parameters for the analog comparator are as follows:

- Sensor: No sensor
- Gain: 1
- Offset: 0
- On Threshold value: 4
- Off Threshold value: 0

The analog comparator switches on the output Q2 if the difference between the flow temperature and the standardized outdoor temperature exceeds 4 °C.

If the difference falls below 0 °C, the analog comparator switches the output Q2 off again.

⑦ Output Q2 switches the heating on and off.

Mode of operation

The outdoor temperature drops, which causes the value issued to the analog amplifier at B004 to increase to the same extent. The difference at the analog comparator between the flow and the outdoor temperature increases accordingly.

If the difference exceeds 4 °C the heating switches on.

By switching on the heating, the flow temperature increases. Because of this, the difference at the analog comparator between the flow and the outdoor temperature decreases (provided the outdoor temperature drops more slowly than the flow temperature increases).

If the difference falls below 0 °C, the heating switches off.

Changing parameters

The Offset parameter at the analog amplifier at B004 depends on your desired flow temperature at 0 °C outdoor temperature. Furthermore, the switch-on threshold and the switch-off threshold of the heating can change by means of the On and Off threshold values of the analog comparator at B005.

Try it out!

The example can be found as a circuit program on the LOGO!Soft Comfort DVD-ROM. Load the circuit program in LOGO!Soft Comfort and try out the instructions above in simulation mode.

4.4 Fill station

Requirements for a fill station

A box shall be filled with two different items, up to a specified total for each item. When all items are in the box, it will be transported to the packaging station. A conveyor belt transports the items of both types to the box. (This example does not show the filling conveyor belt.) This circuit program for this example uses two up/down counters to count the items of each type, a mathematic instruction to sum the total number of items, and message texts to be displayed on the LOGO! onboard display and LOGO! TD (Text Display) that show the number of items of each type and the total number counted so far.

This process is described below:

- To fill the box, each item is transported by a conveyor belt to the box (not part of this example).
- The sequence in which the items fall into the box is random.
- Each item that falls into the box is counted by a sensor.
- The connected LOGO! TD as well as the LOGO! onboard display must display how many items of each kind have been counted, how many total items are in the box.

The circuit program in LOGO!Soft Comfort

Light barriers are connected to the two digital inputs I1 and I2 sensors that detect when an item falls into the box. The two counters (B001 and B002) count each item for the two specific types of items as they fall into the box. The on-threshold of each counter specifies the maximum number possible for each item type. When the box is full, a conveyor belt activates for ten seconds to transport the filled box to the packaging station and to transport an empty box to the fill station.

The circuit program uses a message text function block (Page 315) to display on the LOGO! TD and LOGO! onboard display how many total items and how many of each type have been counted. The message text uses the "ticking" feature to alternate between displaying bar graphs of the counted items and displaying a text summary of the counts.

4.4 Fill station

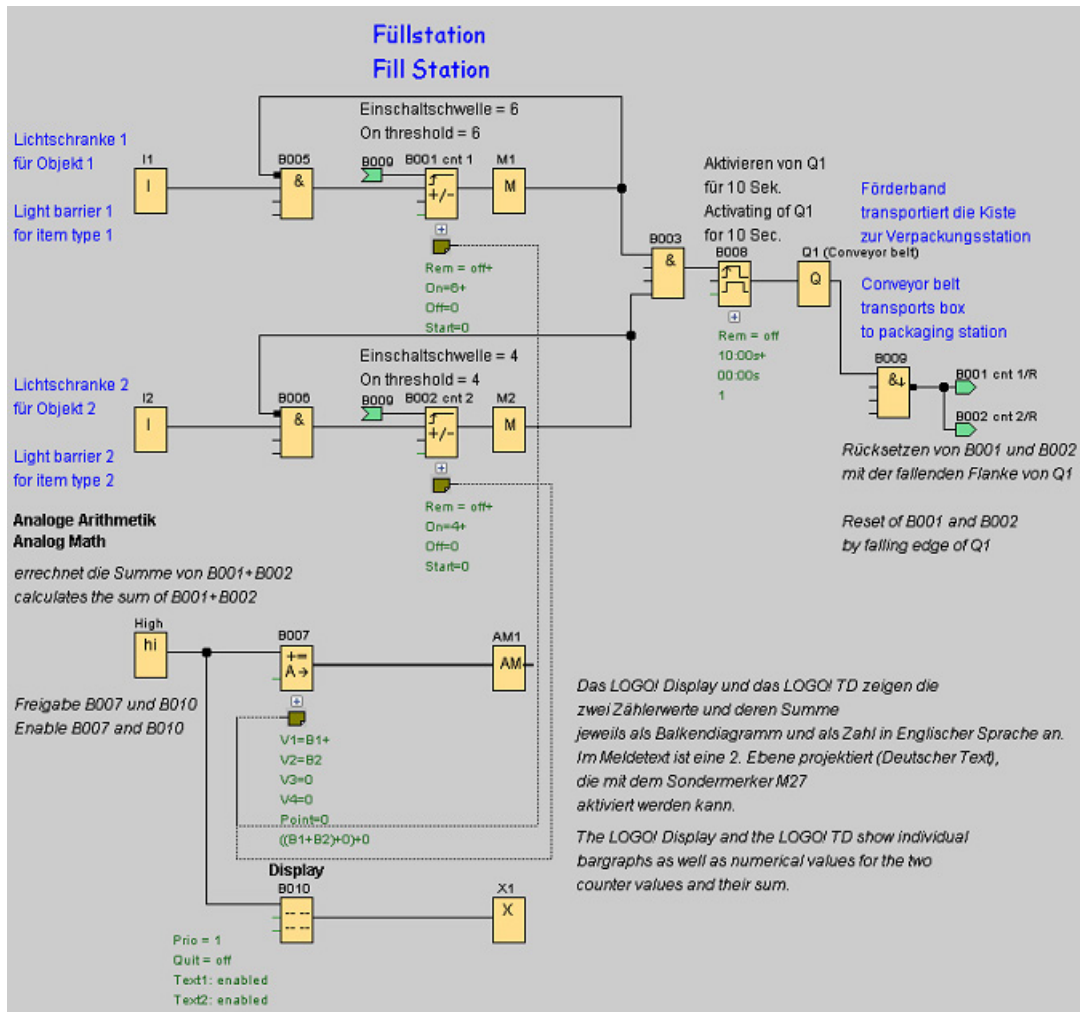

Parameters of the function blocks

Note the following parameter usage:

- The on-thresholds of counters B001 and B002 define the maximum number of items of each item type to be put in the box.
- The pulse width (TH) of the edge-triggered wiping relay defines the duration of the movement of the conveyor belt.
- The mathematic instruction function block B007 that calculates the total is programmed as follows:
 - Value 1 is a reference parameter to the current value of counter B001.
 - Value 2 is a reference parameter to the current value of counter B002.
 - Operator 1 is "+" to sum the two counters.
 - Priority 1 is high. (This is the only operation in the function block, so the priority in this case is irrelevant).
 - The remaining operands and operators are set to "+ 0" and do not affect the output of the equation.

Message texts

Message text block B010 displays a message text whose four lines all tick "line by line", such that two screen forms display in alternation. The first shows bar graph representations of the counted items (B001 and B002 current values) and a bar graph for the summed total items as calculated by B007. The second screen form shows the same values numerically and with text descriptions.

















The message text function block is configured with two character sets enabled. The message text for character set 1 is configured with English text and the message text for character set 2 is configured with German text. You use the File → **Message Text Settings** (Page 52) to select the two character sets. In this case you would select the same character set for both English and German characters. When LOGO! is in run mode, the current character set selection for message texts determines which message will display.

Reference material

5.1 Constants and connectors



You must select this tool if you want to place input blocks, output blocks, flags or constants (high, low) on the programming interface. You can select the specific type of block to insert from an additional toolbar that pops up when you select this tool.

 Display in the FBD Editor	Display in the LAD Editor	Display in the UDF Editor
 Inputs (Page 193)	 Make contact (Page 205)	 Permanent logical levels (Page 194)
 Cursor keys (Page 193)	 Break contact (Page 205)	 Open connectors (Page 195)
 LOGO! TD/LOGO! TDE function keys (Page 193)	 Analog contact (Page 205)	 Flags (Page 195)
 Shift register bits (Page 194)	 Relay coil (Page 206)	 Analog flags (Page 195)
 Permanent logical levels (Page 194)	 Inverted output (Page 206)	
 Outputs (Page 194)	 Analog outputs (Page 197)	
 Open connectors (Page 195)	 Network inputs (0BA7 and 0BA8 only) (Page 198)	
 Flags (Page 195)	 Network analog inputs (0BA7 and 0BA8 only) (Page 200)	
 Analog inputs (Page 196)	 Network outputs (0BA7 and 0BA8 only) (Page 202)	
 Analog outputs (Page 197)	 Network analog outputs (0BA7 and 0BA8 only) (Page 203)	
 Flags (Page 195)		
 Network inputs (0BA7 and 0BA8 only) (Page 198)		
 Network analog inputs (0BA7 and 0BA8 only) (Page 200)		
 Network outputs (0BA7 and 0BA8 only) (Page 202)		
 Network analog outputs (0BA7 and 0BA8 only) (Page 203)		
 The number of available icons depends on the LOGO! version you have selected.		

5.1.1 FBD and UDF

5.1.1.1 Inputs



Input blocks represent the input terminals of LOGO!. Up to 24 digital inputs are available to you.

In your block configuration, you can assign an input block a new input terminal, if this terminal is not already used in the circuit program.

Overview (Page 191)



This block is not available in the UDF Editor.

5.1.1.2 Cursor keys



Up to four cursor keys are available to you. You can program cursor keys for the circuit program in the same ways as other inputs. Cursor keys can save switches and inputs, and allow operator control of the circuit program.

The four cursor keys on the LOGO! TDE are the same cursor key inputs on the LOGO! Base Module. Pressing ESC and any of the cursor keys, for example, on either the LOGO! TDE or LOGO! activates a single input for a cursor key.

Overview (Page 191)



This block is not available in the UDF Editor.

5.1.1.3 LOGO! TD/LOGO! TDE function keys



The LOGO! TD/LOGO! TDE module has four function keys that you can use as digital inputs in your circuit program. You program the function keys in the same way as other inputs in your circuit program. Function keys can save switches and inputs, and allow operator control of the circuit program.

Overview (Page 191)



This block is not available in the UDF Editor.

5.1.1.4 Outputs

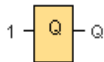

Output blocks represent the output terminals of LOGO!. You can use up to 20 outputs. In your block configuration, you can assign an output block a new terminal, provided this terminal is not already used in your circuit program.

The output always carries the signal of the previous program cycle. This value does not change within the current program cycle.

Overview (Page 191)



This block is not available in the UDF Editor.

5.1.1.5 Permanent logical levels



Set the block input to logical **hi** (hi = high) to set it permanently to logical "H" state.



Set the block input to logical **lo** (lo = low) to set it permanently to logical "L" state.

Overview (Page 191)



This block is available in both FBD and UDF Editors.

5.1.1.6 Shift register bits



The LOGO! 0BA8 devices provide eight shift register bits S1 to S8, which are assigned the read-only attribute in the circuit program. The content of shift register bits can only be modified by means of the shift register special function.

The LOGO! 0BA7 and LOGO! 0BA8 devices provide a maximum of 32 shift registers bits S1.1 to S4.8.

Overview (Page 191)



This block is not available in the UDF Editor.

5.1.1.7 Open connectors



Interconnect the output of an unused block (for example, message texts) with this block. Number of the open connectors: 16 (LOGO! 0BA6) or 64 (LOGO! 0BA7 and LOGO! 0BA8).

Overview (Page 191)



This block is available in both FBD and UDF Editors.

5.1.1.8 Flags

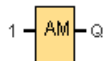
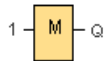

Flag blocks output their input signal. LOGO! 0BA7 provides 27 digital flags M1 to M27 and 16 analog flags AM1 to AM16. LOGO! 0BA8 provides 64 digital flags M1 to M64 and 64 analog flags AM1 to AM64.



0BA6: 27 digital flags M1 to M27; six analog flags AM1 to AM6.

0BA4, 0BA5: 24 digital flags M1 to M24; six analog flags AM1 to AM6

0BA3, 0BA2: eight digital flags M1 to M8

0BA1: four digital flags M1 to M4

0BA0: zero flag

In your block configuration, you can assign a new number to the flag, provided this flag number does not already exist in your circuit program.

The output always carries the signal of the previous program cycle. This value does not change within the current program cycle.

Startup flag: M8

The M8 flag is set in the first cycle of the user program and can thus be used in your circuit program as a startup flag. It is reset after the first program execution cycle.

In the subsequent cycles, the M8 flag reacts in the same way as the M1 to M64 flags.

Backlight flags

Flags M25, M28 and M29 control the backlight of the LOGO! onboard display. Flags M26, M30 and M31 control the backlight of the LOGO! TDE.

You can use the outputs of timers, message texts, or other function blocks to activate the backlight flags. To enable multiple conditions to control the backlight of the devices, you can use multiple function blocks in parallel or in sequence.

Message text character set flag: M27

The M27 flag, if used, determines whether the message texts of the primary character set or the secondary character set will display. You select the two character sets from either LOGO! or the File → Message Text Settings (Page 52) menu command of LOGO!Soft Comfort. Then when you configure message texts (Page 315), you select whether a particular message text consists of characters from the primary character set (Character Set 1) or the secondary character set (Character Set 2).

In the circuit program, you can use M27 to enable the message texts of either the primary or secondary character set and to disable the message texts of the other. When M27=0 (low), then LOGO! only displays the message texts from the primary character set; when M27=1 (high), then LOGO! only displays the message texts from the secondary character set.

Analog flags: AM1 to AM64

The analog flags can be used as markers for analog inputs or analog instruction blocks. The analog flag merely accepts an analog value as input and outputs that value.

Overview (Page 191)



M8, M25, M26, M27, M28, M29, M30 and M31 are not available in the UDF Editor.

5.1.1.9 Analog inputs



The LOGO! 12/24RC, LOGO! 12/24RCo, LOGO! 24, LOGO! 24o, LOGO! 24C, LOGO! 24Co and LOGO! 12/24RCE, as well as the expansion modules LOGO! AM2 12/24 process analog signals. You can use up to eight analog inputs. In your block configuration, you can assign a new input terminal to an input block, provided this terminal is not already used in the circuit program.

Some of the input terminals of the LOGO! 0BA6 versions 12/24RC, 12/24RCo, 24/24o, 24C and 24Co have a dual definition: they can be used as either digital inputs or analog inputs. See the *LOGO! Manual* or product information for specific information about specific modules. Circuit programs written for these modules for the LOGO! 0BA5 release and earlier can run on LOGO! 0BA6 modules without modification. New circuit programs can make use of the new input features, which provide additional fast-speed counters and analog capability.

For help on analog block parameters, refer to information on analog value processing (Page 286).



The block input number is not determined by the hardware structure in systems operating with devices of the 0BA0 to 0BA2 series.

Overview (Page 191)



This block is not available in the UDF Editor.

5.1.1.10 Analog outputs

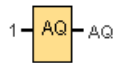

Eight analog outputs are available, namely AQ1, AQ2, ... AQ8. You can only set an analog value at the analog output, that is, a function with an analog output or analog flag AM.

If you connect a special function (that has an analog output) to a **real** analog output, then note that the analog output can only process values from 0 to 1000.

You can configure the behavior of analog outputs for LOGO! 0BA5 and higher versions in STOP mode. Analog outputs can retain their last values when LOGO! goes to STOP mode. Alternatively, you can configure specific values to be set for AQ1 and AQ2 (AQ1 and AQ8 for 0BA8) when LOGO! goes to STOP mode.

You can also set the analog output value range. You have two choices:

- Normal (0 V to 10 V or 0 mA to 20 mA)
- 4 mA to 20 mA



0BA0 to 0BA5: You cannot configure the behavior of AQ1 and AQ2 on transition to STOP mode for LOGO! modules prior to the 0BA5 device series.

Overview (Page 191)



This block is not available in the UDF Editor.

5.1.1.11 Network inputs (0BA7 and 0BA8 only)



You can connect a network input to a block input. You can configure up to 64 network inputs. Network inputs can read values from the following types:

- VM

When reading values from VM, the VB address range is 0 to 850.

- Remote device

When reading values from a remote device, you must enter its IP address or select from the existing device types.

- Remote device types for LOGO! 0BA8

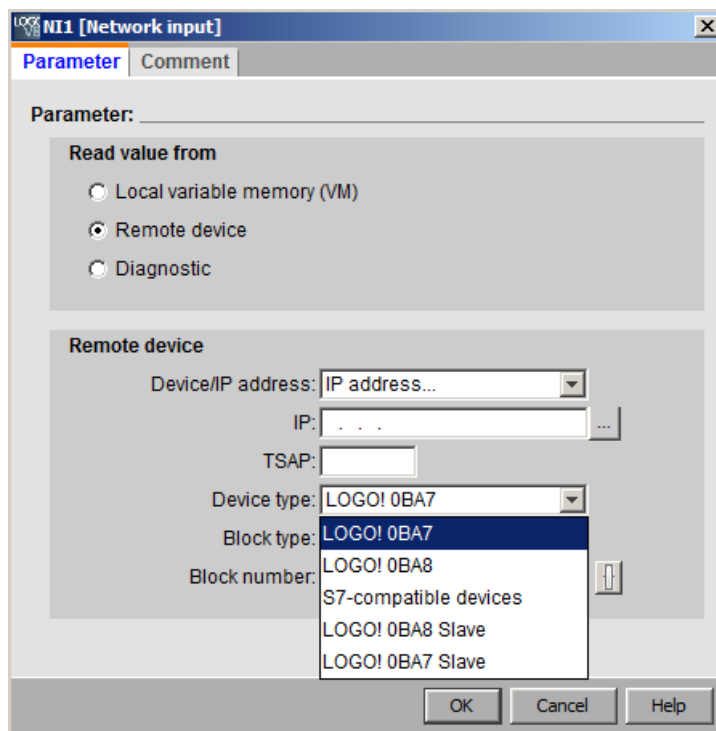

Available device types and their block types are as follows:

Device type	Block type
LOGO! 0BA7 (Page 161)	I1 to I24, Q1 to Q16, M1 to M27, and VB0 to VB850
LOGO! 0BA8 (Page 161)	I1 to I24, Q1 to Q20, M1 to M64, and VB0 to VB850
S7-compatible devices (Page 164)	IB0 to IB65535, QB0 to QB65535, MB0 to MB65535, VB0 to VB65535, DB0 to DB16000, and .DBB0 to .DBB65535
LOGO! 0BA8 Slave (Page 163)	I1 to I24 and Q1 to Q20
LOGO! 0BA7 Slave (Page 163)	I1 to I24 and Q1 to Q16

- Remote device types for LOGO! 0BA7

For LOGO! 0BA7, network inputs can only read values from LOGO! 0BA7 Slave. The block type is the input or output of the slave. Network inputs can read values from I1 to I24 or Q1 to Q16 of a slave Base Module.

- Diagnostics

When reading values from the diagnostic information, you need to select a diagnostic type first, as shown in the following figures. The diagnostic types correspond to the bits in the VM area. Each of the bits is set to 1 or 0, which respectively indicates that an error of this type exists or not.

- LOGO! 0BA8 diagnostic type

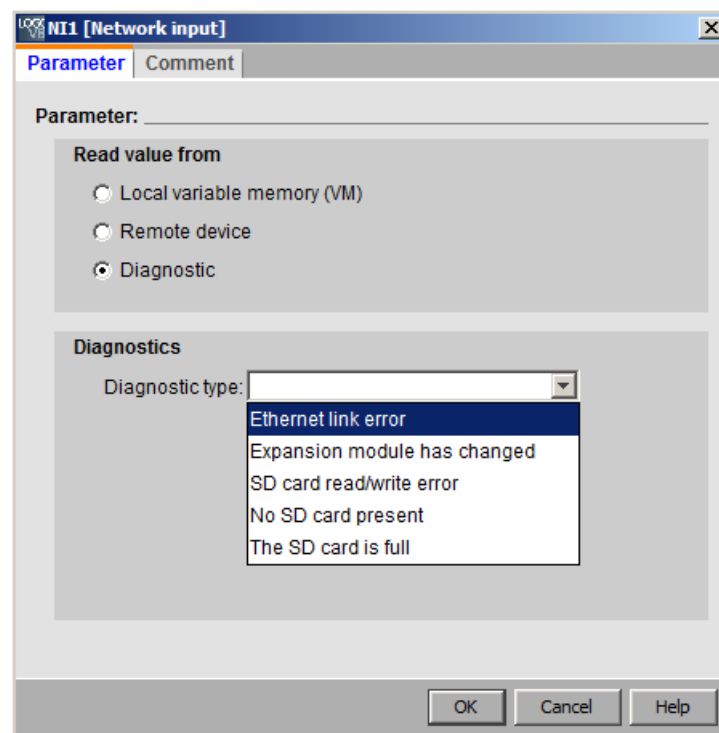

- LOGO! 0BA7 diagnostic type

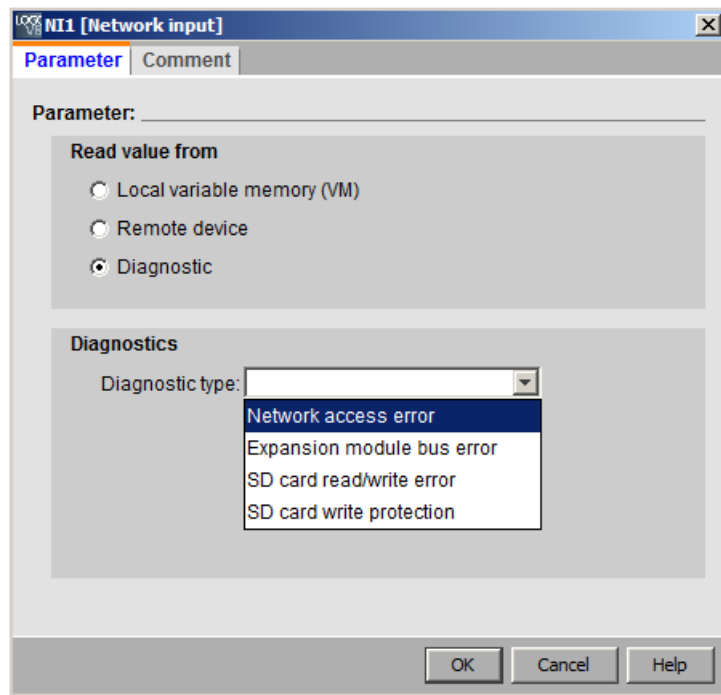

Overview (Page 191)



Network inputs are inactive in the UDF Editor.

5.1.1.12 Network analog inputs (0BA7 and 0BA8 only)

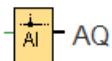

You can connect a network analog input to a block input. You can configure up to 32 network analog inputs.

Network analog inputs can read values from the following types:

- VM
When reading values from VM, the VW address range is 0 to 849.
- Remote device
When reading values from a remote device, you must enter its IP address or select from the existing device types.

- Remote device types for LOGO! 0BA8

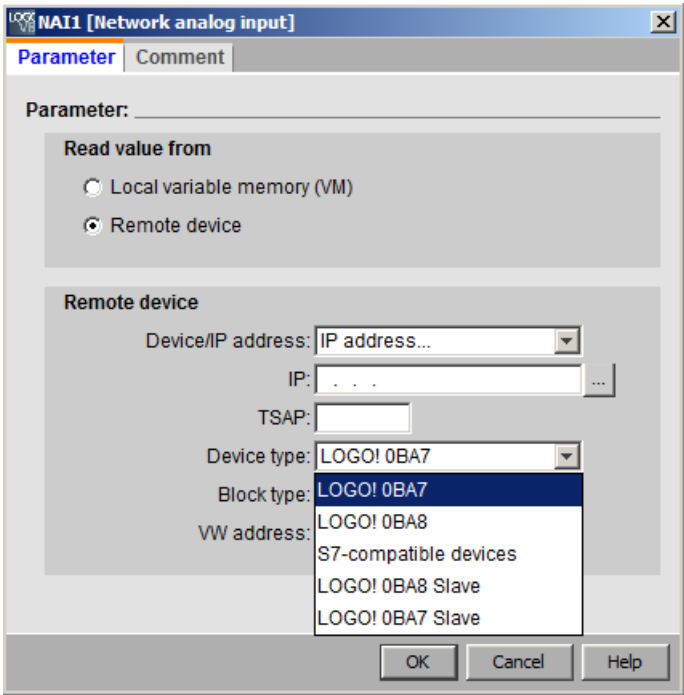

Available remote device types and their block types are as below:

Device type	Block type
LOGO! 0BA7 (Page 161)	VW0 to VW849
LOGO! 0BA8 (Page 161)	VW0 to VW849
S7-compatible devices (Page 164)	IW0 to IW65534, QW0 to QW65534, MW0 to MW65534, VW0 to VW65534, DB0 to DB16000, and .DBW0 to .DBW65534
LOGO! 0BA8 Slave (Page 163)	AI1 to AI8 and AQ1 to AQ8
LOGO! 0BA7 Slave (Page 163)	AI1 to AI8 and AQ1 to AQ2

- Remote device types for LOGO! 0BA7

For LOGO! 0BA7, network analog inputs can only read values from LOGO! 0BA7 Slave. If you read a value from a slave Base Module, you must enter the slave IP address or select the existing LOGO! 0BA7 Slave in the project. Network analog inputs can read values from AI1 to AI8 or AQ1 to AQ2 of a slave Base Module.

Overview (Page 191)



Network analog inputs are inactive in the UDF Editor.

5.1.1.13 Network outputs (0BA7 and 0BA8 only)



When the LOGO! 0BA8 or LOGO! 0BA7 Base Module is in slave mode, you can configure a network output on the master to control a digital output on the remote device. You can configure up to 64 network outputs.

- LOGO! 0BA8

For LOGO! 0BA8, network outputs can write values to the following types:

- VM

When writing values to VM, the VB address range is 0 to 850.

- Remote device

When writing values to a remote device, you must first enter the device IP address or select the existing device.

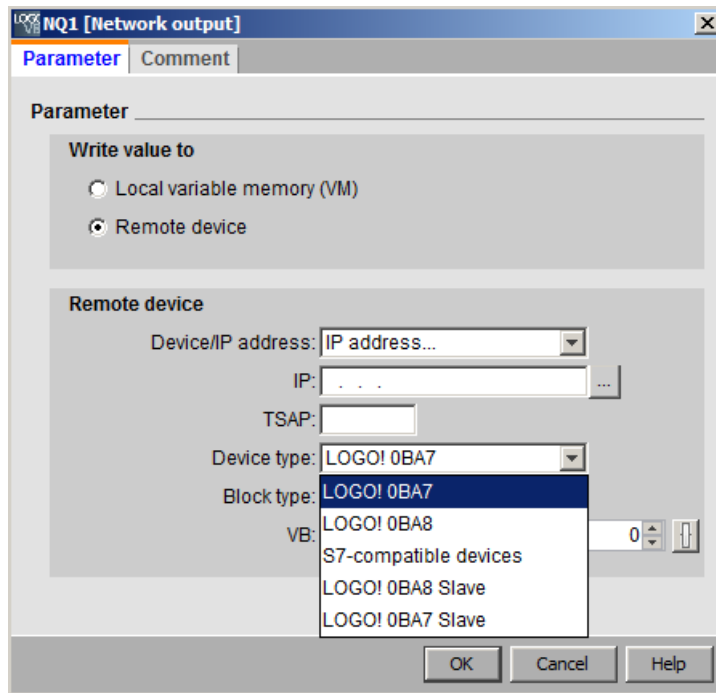

Available device types and their block types are as follows:

Device type	Block type
LOGO! 0BA7 (Page 161)	VB0 to VB850
LOGO! 0BA8 (Page 161)	I1 to I24, Q1 to Q20, M1 to M64 and VB0 to VB 850
S7-compatible devices (Page 164)	IB0 to IB65535, QB0 to QB65535, MB0 to MB65535, VB0 to VB65535, DB0 to DB16000 and .DBB0 to .DBB65535
LOGO! 0BA8 Slave (Page 163)	Q1 to Q20
LOGO! 0BA7 Slave (Page 163)	Q1 to Q16

- LOGO! 0BA7

For LOGO! 0BA7, network outputs can only write values to LOGO! 0BA7 Slave. If you write a value to a slave Base Module, you must enter the slave IP address or select the existing LOGO! 0BA7 Slave. The block number is from Q1 to Q16.

Overview (Page 191)



Network outputs are inactive in the UDF Editor.

5.1.1.14 Network analog outputs (0BA7 and 0BA8 only)



When the LOGO! 0BA7 or LOGO! 0BA8 Base Module is in slave mode, you can configure a network analog output on the master to control an analog output on the slave. You can configure up to 16 network analog outputs.

- LOGO! 0BA8

For LOGO! 0BA8, network analog outputs can write values to the following types:

- VM

When writing values to VM, the VW address range is 0 to 849.

- Remote device

When writing values to a remote device, you must first enter the device IP address or select the existing device.

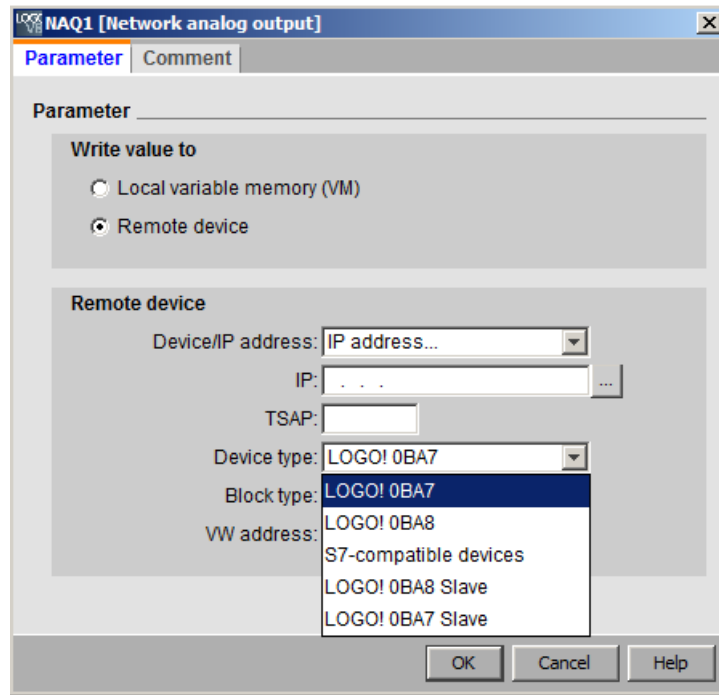

Available device types and their block types are as follows:

Device type	Block type
LOGO! 0BA7 (Page 161)	VW0 to VW849
LOGO! 0BA8 (Page 161)	VW0 to VW849
S7-compatible devices (Page 164)	IW0 to IW65534, QW0 to QW65534, MW0 to MW65534, VW0 to VW65534, DB0 to DB16000 and .DBW0 to .DBW65534
LOGO! 0BA8 Slave (Page 163)	AQ1 to AQ8
LOGO! 0BA7 Slave (Page 163)	AQ1 to AQ2

- LOGO! 0BA7

For LOGO! 0BA7, network analog outputs can only write values to LOGO! 0BA7 Slave. If you write a value to a slave Base Module, you must enter the slave IP address or select the existing LOGO! 0BA7 Slave. The block number is from AQ1 to AQ2.

Overview (Page 191)



Network analog outputs are inactive in the UDF Editor.

5.1.2 LAD

5.1.2.1 Make contact



Make contacts, as well as break contacts (Page 205) and analog contacts (Page 205) represent the input terminals of a LOGO! module.

When you place a contact in your circuit program, LOGO!Soft Comfort displays a relevant dialog. In this dialog, you can specify the type of input according to the LOGO! in use. The cursor keys are also available as inputs as are the LOGO! TDE function keys if you have a LOGO! TDE module. You can also select a fixed logical level for the input.

To change an input in your LAD circuit program, double-click the corresponding block to open the relevant dialog.

Overview (Page 191)

5.1.2.2 Break contact



Break contacts, as well as make contacts (Page 205) and analog contacts (Page 205) represent the input terminals of a LOGO! module.

When you place the contact in your circuit program, LOGO!Soft Comfort displays a relevant dialog. In this dialog you can specify the type of input according to your LOGO!. The cursor keys are also available as inputs as are the LOGO! TDE function keys if you have a LOGO! TDE module. You can also select a fixed logical level for the input.

To change an input in your LAD circuit program, double-click the corresponding block to open a dialog in which you can make your changes.

Overview (Page 191)

5.1.2.3 Analog contact



Analog contacts, as well as break contacts (Page 205) and make contacts (Page 205) represent the input terminals of a LOGO! device.

When you place a contact in your circuit program, LOGO!Soft Comfort displays a relevant dialog. In this dialog you can specify the type of input according to your LOGO! device.

To change an input in your LAD circuit program, double-click the corresponding block in your circuit program to open a dialog in which you can make your changes.

Overview (Page 191)

5.1 Constants and connectors

5.1.2.4 Relay coil



Relay coils represent the output terminals like inverted outputs (Page 206) and analog outputs (Page 206) on a LOGO!.

To change an output in your LAD circuit program, double-click the corresponding block to open a dialog in which you can assign various functions to the output.

Overview (Page 191)

5.1.2.5 Inverted output



Inverted outputs, as well as relay coils (Page 206) and analog outputs (Page 206) represent the output terminals of a LOGO! device.

To change an output in your LAD circuit program, double-click the corresponding block to open a dialog in which you can assign various functions to the output.

Overview (Page 191)

5.1.2.6 Analog output



Analog outputs represent the output terminals like relay coils (Page 206) and inverted output (Page 206) on a LOGO!.

To change an output in your LAD circuit program, double-click the corresponding block to open a dialog in which you can assign various functions to the output.

If you connect a special function that has an analog output to a **real** analog output, then note that the analog output can only process values from 0 to 1000.

Overview (Page 191)

5.1.2.7 Network inputs (0BA7 and 0BA8 only)

Refer to Network inputs (0BA7 and 0BA8 only) (Page 198) in the FBD Editor.

5.1.2.8 Network analog inputs (0BA7 and 0BA8 only)

Refer to Network analog inputs (0BA7 and 0BA8 only) (Page 200) in the FBD Editor.

5.1.2.9 Network outputs (0BA7 and 0BA8 only)

Refer to Network outputs (0BA7 and 0BA8 only) (Page 202) in the FBD Editor.

5.1.2.10 Network analog outputs (OBA7 and OBA8 only)

Refer to Network analog outputs (OBA7 and OBA8 only) (Page 203) in the FBD Editor.

5.2 Basic functions (FBD and UDF Editors)



Select this tool if you want to place standard Boolean logic blocks on the programming interface. LOGO!Soft Comfort then displays a toolbar with all of the Boolean logic blocks:



AND (Page 208)



OR (Page 210)



AND with edge evaluation (Page 208)



NOR (Page 211)



NAND (Page 209)



XOR (Page 211)



NAND with edge evaluation (Page 209)



NOT (Page 212)

Select the block that you need to place it on the programming interface.

Inverting the inputs

You can invert individual inputs:

- A logical "1" at a specific input is inverted to logical "0" in the circuit program.
- A logical "0" is inverted to logical "1" in the circuit program.

To invert an input, right-click the input and select the **invert** command from the shortcut menu.

You cannot invert the inputs of output blocks.



OBA0-OBA3:

To invert an input, use the basic function NOT (Page 212).

Timing diagrams

Each timing diagram of the basic functions displays three inputs to make evaluation easier for you.



OBA0-OBA3:

The basic functions have three inputs.

5.2.1 AND



The output of an AND function is only 1 if **all** inputs are 1, that is, when they are closed.

A block input that is not used (x) is assigned: $x = 1$.

AND function logic table

Input 1	Input 2	Input 3	Input 4	Output
0	0	0	0	0
0	0	0	1	0
0	0	1	0	0
0	0	1	1	0
0	1	0	0	0
0	1	0	1	0
0	1	1	0	0
0	1	1	1	0
1	0	0	0	0
1	0	0	1	0
1	0	1	0	0
1	0	1	1	0
1	1	0	0	0
1	1	0	1	0
1	1	1	0	0
1	1	1	1	1

Overview (Page 207)

5.2.2 AND with edge evaluation

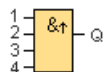

The output of an AND function with edge evaluation is only 1 if **all** inputs are 1 and **at least one** input was 0 during the last cycle.

The output is set to 1 for the duration of one cycle and must be reset to 0 for the duration of the next cycle before it can be set to 1 again.

A block input that is not used (x) is assigned: $x = 1$.

Timing diagram of an AND with edge evaluation:

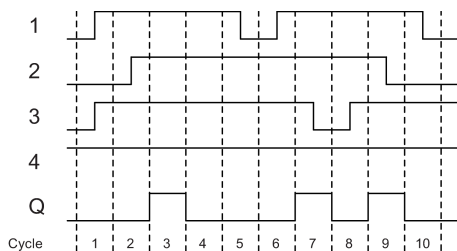

Overview (Page 207)

5.2.3 NAND

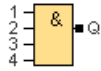

The output of an NAND function is only 0 if **all** inputs are 1, i.e. when they are closed.

A block input that is not used (x) is assigned: $x = 1$.

NAND function logic table

Input 1	Input 2	Input 3	Input 4	Output
0	0	0	0	1
0	0	0	1	1
0	0	1	0	1
0	0	1	1	1
0	1	0	0	1
0	1	0	1	1
0	1	1	0	1
0	1	1	1	1
1	0	0	0	1
1	0	0	1	1
1	0	1	0	1
1	0	1	1	1
1	1	0	0	1
1	1	0	1	1
1	1	1	0	1
1	1	1	1	0

Overview (Page 207)

5.2.4 NAND with edge evaluation

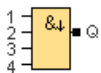

The output is set to 1 for the duration of one cycle and must be reset to 0 at least for the duration of the next cycle before it can be set to 1 again.

A block input that is not used (x) is assigned: $x = 1$.

Timing diagram of a NAND with edge evaluation

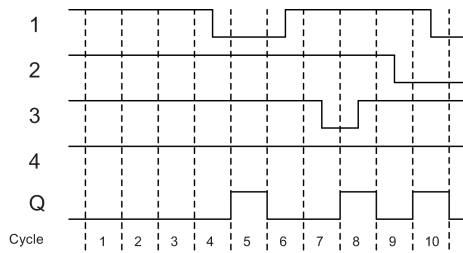

Overview (Page 207)

5.2.5 OR

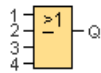

The output of an OR function is 1 if **at least one** input is 1 (closed).

A block input that is not used (x) is assigned: x = 0.

OR function logic table

Input 1	Input 2	Input 3	Input 4	Output
0	0	0	0	0
0	0	0	1	1
0	0	1	0	1
0	0	1	1	1
0	1	0	0	1
0	1	0	1	1
0	1	1	0	1
0	1	1	1	1
1	0	0	0	1
1	0	0	1	1
1	0	1	0	1
1	0	1	1	1
1	1	0	0	1
1	1	0	1	1
1	1	1	0	1
1	1	1	1	1

Overview (Page 207)

5.2.6 NOR

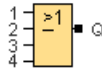

The output of an NOR (NOT OR) function is only 1 if **all** inputs are 0 (open). When one of the inputs is on (logical 1 state), the output is off.

A block input that is not used (x) is assigned: $x = 0$.

NOR function logic table

Input 1	Input 2	Input 3	Input 4	Output
0	0	0	0	1
0	0	0	1	0
0	0	1	0	0
0	0	1	1	0
0	1	0	0	0
0	1	0	1	0
0	1	1	0	0
0	1	1	1	0
1	0	0	0	0
1	0	0	1	0
1	0	1	0	0
1	0	1	1	0
1	1	0	0	0
1	1	0	1	0
1	1	1	0	0
1	1	1	1	0

Overview (Page 207)

5.2.7 XOR

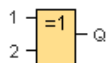

The output of an XOR (exclusive OR) function is 1 if the signal status of the inputs is **different**.

A block input that is not used (x) is assigned: $x = 0$.

XOR function logic table

Input 1	Input 2	Output
0	0	0
0	1	1
1	0	1
1	1	0

Overview (Page 207)

5.2.8 NOT

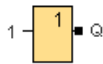

The output of an NOT function is 1 if the input is 0. The NOT block inverts the input status.

Advantage of the NOT, for example: LOGO! no longer requires break contacts. You simply use a make contact and convert it into a break contact with the help of the NOT function.

NOT function logic table

Input 1	Output
0	1
1	0

Overview (Page 207)

5.3 Special functions



Select this tool if you want to place additional retentive or time-related function blocks on the programming interface. LOGO!Soft Comfort then displays a toolbar of special function icons:

Timers



On-delay (Page 217)



Off-delay (Page 218)



On-/Off-delay (Page 220)

Analog











Analog threshold trigger (Page 255)



Analog differential trigger (Page 260)



Analog comparator (Page 262)

	Retentive on-delay (Page 222)		Analog watchdog (Page 265)
	Wiping relay (pulse output) (Page 224)		Analog amplifier (Page 268)
	Edge triggered wiping relay (Page 225)		Analog multiplexer (Page 269)
	Symmetrical pulse generator (Page 227)		Pulse Width Modulator (PWM) (Page 273)
	Asynchronous pulse generator (Page 228)		Mathematic instruction (Page 276)
	Random generator (Page 230)		PI controller (Page 300)
	Stairway lighting switch (Page 232)		Analog ramp (Page 304)
	Multiple function switch (Page 234)		Analog filter (0BA7 and 0BA8 only) (Page 279)
	Weekly timer (Page 236)		Max/Min (0BA7 and 0BA8 only) (Page 280)
	Yearly timer (Page 239)		Average value (0BA7 and 0BA8 only) (Page 285)
	Astronomical clock (0BA7 and 0BA8 only) (Page 243)	Miscellaneous	
	Stopwatch (0BA7 and 0BA8 only) (Page 245)		Latching relay (Page 307)
Counter			Pulse relay (Page 308)
	Up/Down counter (Page 247)		Message text (LOGO! 0BA4 and LOGO! 0BA5) (Page 327), Message text (LOGO! 0BA6 and LOGO! 0BA7) (Page 315), Message text (LOGO! 0BA8) (Page 310)
	Hours counter (Page 249)		Softkey (Page 331)
	Threshold trigger (Page 253)		Shift register (0BA4 to 0BA6) (Page 335) , Shift register (0BA7 to 0BA8) (Page 333)
			Mathematic instruction error detection (Page 337)



The **LAD Editor** offers you the following additional functions:
AND with edge evaluation (Page 208)
NAND with edge evaluation (Page 209)



FBD and UDF Editors: description of the blocks of special functions

The description of the blocks of special functions in the circuit program begins with timer blocks ("T"), with counter blocks ("C") and with the remaining blocks ("SF").



The LOGO! version you have selected determines these characteristics of your circuit program:

- Available blocks
- Parameters that you can set

This topic also describes the following tasks or characteristics of the special functions:

- Inverting inputs
- Block configuration
- Reference parameters
- Protection
- Retentivity

Inverting inputs

You can invert individual inputs:

- You can invert a logical "1" at a specific input to logical "0" in the circuit program.
- You can invert a logical "0" to logical "1" in the circuit program.

To do so, right-click the input and select the **invert** command from the shortcut menu.

You cannot invert the inputs of output blocks.

Note

- Unused logical inputs default to logical "0".
 - You can not invert the inputs of a UDF block.
-



0BA0-0BA3:

To invert an input, use the basic function NOT (Page 212)

Block configuration

The block properties dialog provides you with an easy means of setting the various block parameters.

Reference functionality

You can also assign parameters to blocks with the value from other blocks. Such parameters are reference parameters.

The parameter box displays the block's parameters in a table. You can reference any parameter in the parameter box to the parameter of another function. You can use the show/hide button to change the visibility of the parameter box.

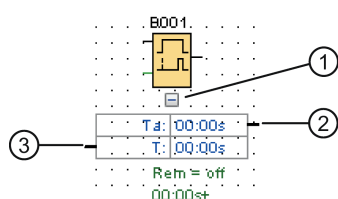

① Show/hide button

② Output connector

③ Input connector

Each parameter has an input connector and/or an output connector. You can simply use drag and drop to create a reference line between the parameter connector of one function and the parameter connector of another function. Note that you cannot connect output parameters to other output parameters.

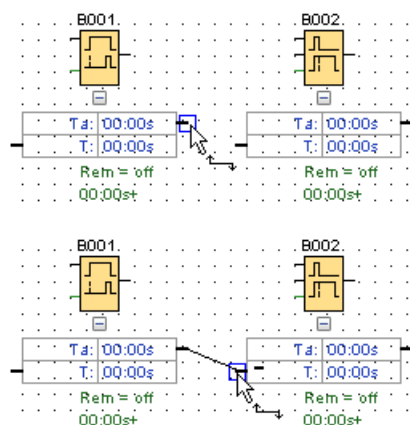

The reference line between two parameters indicates their reference relation. You can delete the reference line to remove the reference.

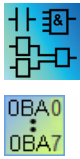

LAD Editor/0BA4-0BA7:

The parameter box is not available in the LAD Editor or for 0BA4-0BA7 devices.

Follow the below steps to create a reference:

1. Click the "Reference" button next to a parameter in the block properties window.
2. LOGO!Soft Comfort displays all the blocks available for providing the reference parameter.
3. Select the block you want to refer to.

For example, if you click the "Reference" button for the Off-Delay parameter of an Off-Delay timer, you can then choose a specific block to reuse the time value of that timer.

	A quick way of changing block parameters (Page 371)
--	---

LOGO! 0BA7 and LOGO! 0BA8 devices provide a timer reference function. With this function, you can take the current time (Ta) of a timer as the reference value (C) in other function blocks. The calculation of the reference value (C) follows the formula as shown below:

Current time (Ta)	Time base	Reference value (C)
A : B	Hours (h : m)	$C = A \times 60 + B$
A : B	Minutes (m : s)	$C = A \times 60 + B$
A : B	Seconds (s: 1/100s)	$C = A \times 100 + B$

Protection

If a **Protection Active** check box exists for the protection of a block parameter, you can enable or lock the display and editing of this parameter in LOGO! configuration mode.

Retentivity

The switching state and counter values of SFBs can be retentive. This means that the current data values are retained, for example after a power failure, so that the function is resumed at the break position after power on. Hence, a timer is not reset, but instead the time-to-go expires.

You must set the retentivity to enable this feature for the relevant function. There are two possible settings:

- On: Current data values are retained.
- Off: Current data values are not retained (default).

The Hours counter (Page 249) is an exception, because it is always retentive.

5.3.1 Timers

5.3.1.1 On-delay

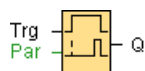

Short description

The output does not switch on until a configured delay time has expired.

Connection	Description
Trg input	The Trg (Trigger) input triggers the on-delay time.
Parameter	T: represents the on-delay time after which the output is switched on (output signal transition 0 to 1). Retentivity on = the status is retentive in memory.
Output Q	Q switches on after a specified time T has expired, provided Trg is still set.

Parameter T

The actual value of another already-programmed function can provide the time in parameter T:

- Analog comparator: Ax - Ay
- Analog threshold trigger: Ax
- Analog amplifier: Ax
- Analog multiplexer: AQ
- Analog ramp: AQ
- Mathematic instruction: AQ
- PI controller: AQ
- Up/Down counter: Cnt

For the **OBA7** and **OBA8** devices, you can additionally use the actual values of the following already-programmed functions:

- On-delay: Ta
- Off-delay: Ta
- On-/off-delay: Ta
- Retentive on-delay: Ta
- Wiping relay(pulse output): Ta
- Edge triggered wiping relay: Ta
- Asynchronous pulse generator: Ta
- Stairway light switch: Ta

- Multiple function switch: Ta
- Stopwatch: AQ
- Analog filter: AQ
- Average value: AQ
- Max/Min: AQ
- Threshold trigger: Fre

You can select the required function by the block number.

For information on the validity and accuracy of the time base, refer to the *LOGO! manual*.

Timing diagram

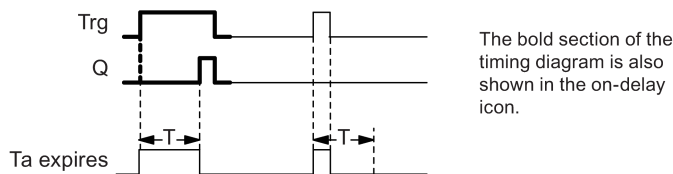

Description of the function

The 0 to 1 transition at input Trg triggers the time Ta (the current time in LOGO!).

If the status at input Trg stays 1 at least for the duration of the configured time T, the output is set to 1 when this time has expired (the on signal of the output follows the on signal of the input with delay).

The time is reset if the status at input Trg changes to 0 again before the time T has expired.

The output is reset to 0 when input Trg is 0.

Special functions (Page 212)

5.3.1.2 Off-delay



Short description

The output with off-delay resets after a defined time has expired.

Connection	Description
Input Trg	Start the off-delay time with a negative edge (1 to 0 transition) at input Trg (Trigger).
Input R	Reset the off-delay time and set the output to 0 via the R (Reset) input. Reset has priority over Trg .

Parameter	T : The output is switched off on expiration of the delay time T (output signal transition 1 to 0). Retentivity on = the status is retentive in memory.
Output Q	Q switches on for the duration of the time T after a trigger at input Trg .

Parameter T

The actual value of another already-programmed function provides the time set in parameter T:

- Analog comparator: Ax - Ay
- Analog threshold trigger: Ax
- Analog amplifier: Ax
- Analog multiplexer: AQ
- Analog ramp: AQ
- Mathematic instruction: AQ
- PI controller: AQ
- Up/Down counter: Cnt

For the **OBA7** and **OBA8** devices, you can additionally use the actual values of the following already-programmed functions:

- On-delay: Ta
- Off-delay: Ta
- On-/off-delay: Ta
- Retentive on-delay: Ta
- Wiping relay(pulse output): Ta
- Edge triggered wiping relay: Ta
- Asynchronous pulse generator: Ta
- Stairway light switch: Ta
- Multiple function switch: Ta
- Stopwatch: AQ
- Analog filter: AQ
- Average value: AQ
- Max/Min: AQ
- Threshold trigger: Fre

You select the required function by the block number.

For information on the validity and accuracy of the time base, refer to the *LOGO! Manual*.

Timing diagram

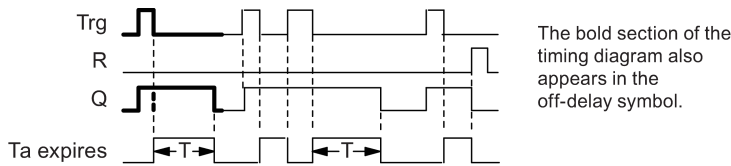

Description of the function

A 0 to 1 transition at input Trg sets output Q to 1 instantaneously.

At the 1 to 0 transition at input Trg, LOGO! retriggers the current time T, and the output remains set. LOGO! resets the output Q to 0 when T_a reaches the value specified in T ($T_a=T$) (off delay).

A one-shot at input Trg retriggers the time T_a .

You can reset the time T_a and the output via the input R (Reset) before the time T_a has expired.

Special functions (Page 212)

5.3.1.3 On-/Off-delay



Short description

The on-/off- delay function block can set an output after a configured on-delay time and then reset it again upon expiration of a second configured time.

Connection	Description
Input Trg	You trigger the on-delay with a positive edge (0 to 1 transition) at input Trg (Trigger). You trigger the off-delay with a negative edge (1 to 0 transition).
Parameter	T_H is the on-delay time for the output (output signal transition 0 to 1). T_L is the off-delay time for the output (output signal transition 1 to 0). Retentivity on = the status is retentive in memory
Output Q	Q switches on upon expiration of a configured time T_H if Trg is still set. It switches off again upon expiration of the time T_L and if Trg has not been set again.

Parameters T_H and T_L

The actual value of another already-programmed function can provide the on-delay time and off-delay time set in parameter T_H and T_L :

- Analog comparator: Ax - Ay
- Analog threshold trigger: Ax
- Analog amplifier: Ax
- Analog multiplexer: AQ
- Analog ramp: AQ
- Mathematic instruction: AQ
- PI controller: AQ
- Up/Down counter: Cnt

For the **OBA7** and **OBA8** devices, you can additionally use the actual values of the following already-programmed functions:

- On-delay: Ta
- Off-delay: Ta
- On-/off-delay: Ta
- Retentive on-delay: Ta
- Wiping relay(pulse output): Ta
- Edge triggered wiping relay: Ta
- Asynchronous pulse generator: Ta
- Stairway light switch: Ta
- Multiple function switch: Ta
- Stopwatch: AQ
- Analog filter: AQ
- Average value: AQ
- Max/Min: AQ
- Threshold trigger: Fre

You select the required function by the block number.

For information on the validity and accuracy of the time base, refer to the *LOGO! Manual*.

Timing diagram

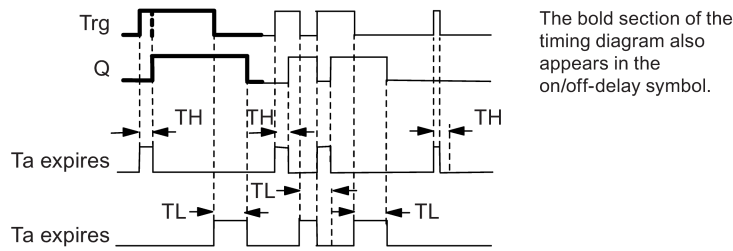

Description of the function

A 0 to 1 transition at input Trg triggers the time T_H .

If the status at input Trg is 1 for at least the duration of the configured time T_H , LOGO! sets the output to logical 1 upon expiration of this time (output is on-delayed to the input signal).

The time T_H resets if the status at input Trg resets to 0 before this time has expired.

The 1 to 0 transition at the output triggers the time T_L is triggered.

If the status at input Trg remains 0 at least for the duration of a configured time T_L , the output resets to 0 upon expiration of this time (output is off delayed to the input signal).

The time T_L resets if the status at input Trg returns to 1 before this time has expired.

Special functions (Page 212)

5.3.1.4 Retentive on-delay



Short description

A one-shot at the input triggers a configurable time. LOGO! sets the output upon expiration of this time.

Connection	Description
Input Trg	Trigger the on-delay time via the Trg (Trigger) input.
Input R	Reset the on-delay time and reset the output to 0 via input R (Reset). Reset takes priority over Trg .
Parameter	T is the on-delay time for the output (output signal transition 0 to 1).
Output Q	Q switches on upon expiration of the time T .

Parameter T

The value of another already-programmed function can provide the time in parameter T:

- Analog comparator: Ax - Ay
- Analog threshold trigger: Ax
- Analog amplifier: Ax
- Analog multiplexer: AQ
- Analog ramp: AQ
- Mathematic instruction: AQ
- PI controller: AQ
- Up/Down counter: Cnt

For the **OBA7** and **OBA8** devices, you can additionally use the actual values of the following already-programmed functions:

- On-delay: Ta
- Off-delay: Ta
- On-/off-delay: Ta
- Retentive on-delay: Ta
- Wiping relay(pulse output): Ta
- Edge triggered wiping relay: Ta
- Asynchronous pulse generator: Ta
- Stairway light switch: Ta
- Multiple function switch: Ta
- Stopwatch: AQ
- Analog filter: AQ
- Average value: AQ
- Max/Min: AQ
- Threshold trigger: Fre

You select the required function by the block number.

Timing diagram



The bold section of the timing diagram is also shown in the symbol of the retentive on-delay.

Description of the function

A 0 to 1 signal transition at input Trg triggers the current time Ta. LOGO! sets the output Q to 1 when Ta reaches the time T. A further pulse at input Trg does not affect Ta.

The output and the time Ta reset to 0 only with a 1 signal at input R.

If you do not set the retentivity, output Q and the expired time reset after a power failure.

Special functions (Page 212)

5.3.1.5 Wiping relay (pulse output)



Short description

An input signal generates an output signal of a configurable length.

Connection

Connection	Description
Input Trg	You trigger the time for the wiping relay with a signal at input Trg (Trigger).
Parameter	T represents the time after which the output resets (output signal transition 1 to 0). Retentivity on = the status is retentive in memory.
Output Q	A pulse at Trg sets Q . The output stays set until the time T has expired and if Trg = 1 for the duration of this time. A 1 to 0 transition at Trg prior to the expiration of T also resets the output to 0.

Parameter T

The actual value of another already-programmed function can provide the off time T:

- Analog comparator: Ax - Ay
- Analog threshold trigger: Ax
- Analog amplifier: Ax
- Analog multiplexer: AQ
- Analog ramp: AQ
- Mathematic instruction: AQ
- PI controller: AQ
- Up/Down counter: Cnt

For the **OBA7** and **OBA8** devices, you can additionally use the actual values of the following already-programmed functions:

- On-delay: Ta
- Off-delay: Ta
- On-/off-delay: Ta
- Retentive on-delay: Ta
- Wiping relay(pulse output): Ta
- Edge triggered wiping relay: Ta
- Asynchronous pulse generator: Ta
- Stairway light switch: Ta
- Multiple function switch: Ta
- Stopwatch: AQ
- Analog filter: AQ
- Average value: AQ
- Max/Min: AQ
- Threshold trigger: Fre

You select the required function by the block number.

Timing diagram

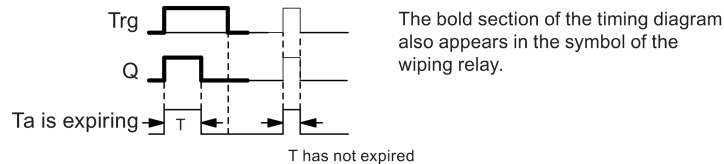

Description of the function

The input signal $Trg = 1$ sets the output Q to 1. The signal also triggers the time Ta , while the output remains set.

When Ta reaches the value defined at T ($Ta=T$), the output Q resets to 0 state (pulse output).

If the signal at input Trg changes from 1 to 0 before this time has expired, the output immediately resets from 1 to 0.

Special functions (Page 212)

5.3.1.6 Edge triggered wiping relay



Short description

An input pulse generates a preset number of output pulses with a defined pulse/pause ratio (retriggerable), after a configured delay time has expired.

Connection	Description
Input Trg	You trigger the times for the Edge-triggered wiping relay with a signal at input Trg (Trigger).
Input R	The output and the current time Ta resets to 0 with a signal at input R .
Parameter	T_H, T_L : The pulse width T_H and the interpulse width T_L are adjustable. N determines the number of pulse/pause cycles T_L/T_H : Value range: 1 to 9. Retentivity on = the status is retentive in memory.
Output Q	Output Q sets when the time T_L has expired and resets when T_H has expired.



OBA2, OBA3:

Only the parameter **T_H** exists. **T_H** represents the off-delay time for the output. Input **R** is not available.

Parameters **T_H and **T_L****

The actual value of another already-programmed function can provide the pulse width **T_H** and the interpulse width **T_L**:

- Analog comparator: Ax - Ay
- Analog threshold trigger: Ax
- Analog amplifier: Ax
- Analog multiplexer: AQ
- Analog ramp: AQ
- Mathematic instruction: AQ
- PI controller: AQ
- Up/Down counter: Cnt

For the **OBA7** and **OBA8** devices, you can additionally use the actual values of the following already-programmed functions:

- On-delay: Ta
- Off-delay: Ta
- On-/off-delay: Ta
- Retentive on-delay: Ta
- Wiping relay(pulse output): Ta
- Edge triggered wiping relay: Ta
- Asynchronous pulse generator: Ta
- Stairway light switch: Ta

- Multiple function switch: Ta
- Stopwatch: AQ
- Analog filter: AQ
- Average value: AQ
- Max/Min: AQ
- Threshold trigger: Fre

You select the required function by the block number.

Timing diagram

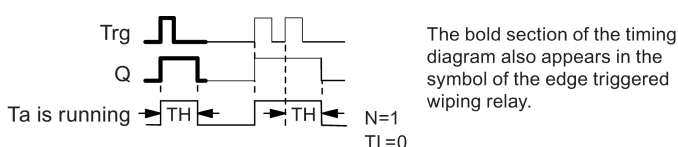

Description of the function

The change at input Trg to 1 triggers the time T_L (time low). After the time T_L has expired, LOGO! sets the output Q to 1 for the duration of the time T_H (time high).

If LOGO! retriggers the input Trg prior to the expiration of the preset time ($T_L + T_H$), the time Ta resets and the pulse/pause period is restarted.

Special functions (Page 212)

5.3.1.7 Symmetrical pulse generator



The symmetrical pulse generator is only available for devices of the series OBA3.

LOGO! devices of the current series use an asynchronous pulse generator (Page 228) instead of the symmetrical pulse generator.

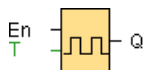

Short description

The function outputs a pulse signal with a configurable period.

Connection	Description
Input En	You enable (En=1) or disable (En=0) the pulse generator with the signal at input En (Enable).
Parameter	T is the on or off time of the output.
Output Q	Q is toggled periodically on and off with the pulse time T .

Timing diagram

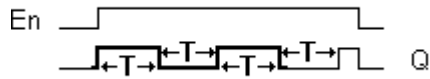

Description of function

You define the length of the on and off times at the parameter T. The **En** input enables the pulse generator. The pulse generator sets the output to 1 for the duration of the time T, then to 0 for the duration of the time T and so forth, until input En = 0.

Always specify a time T of 0.1 s. A time T is not defined for T = 0.05 s and T = 0.00 s.

Special functions (Page 212)

5.3.1.8 Asynchronous pulse generator

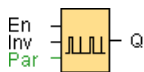

Description of function

The pulse shape at the output can be modified by a configurable pulse/pause ratio.

Connection	Description
Input En	You enable/disable the asynchronous pulse generator with the signal at input En .
Input Inv	The Inv input can be used to invert the output signal of the active asynchronous pulse generator.
Parameter	T_H, T_L : You can customize the pulse width (T_H) and the interpulse width (T_L).
Output Q	Q is toggled on and off cyclically with the pulse/pause times T_H and T_L .

Parameters **T_H** and **T_L**

The pulse width **T_H** and the interpulse width **T_L** can be provided by the actual value of another already-programmed function:

- Analog comparator: Ax - Ay
- Analog threshold trigger: Ax
- Analog amplifier: Ax
- Analog multiplexer: AQ
- Analog ramp: AQ
- Mathematic instruction: AQ
- PI controller: AQ
- Up/Down counter: Cnt

For the **OBA7** and **OBA8** devices, you can additionally use the actual values of the following already-programmed functions:

- On-delay: Ta
- Off-delay: Ta
- On-/off-delay: Ta
- Retentive on-delay: Ta
- Wiping relay(pulse output): Ta
- Edge triggered wiping relay: Ta
- Asynchronous pulse generator: Ta
- Stairway light switch: Ta
- Multiple function switch: Ta
- Stopwatch: AQ
- Analog filter: AQ
- Average value: AQ
- Max/Min: AQ
- Threshold trigger: Fre

You select the required function by the block number.

Timing diagram



Description of the function

You can set the pulse/pause ratio at the TH (Time High) and TL (Time Low) parameters.

The INV input can be used to invert the output signal. The input block INV only inverts the output signal if the block is enabled with EN.

Special functions (Page 212)

5.3.1.9 Random generator

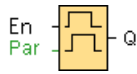

Short description

The output of a random generator is toggled within a configurable time.

Connection	Description
Input En	The positive edge (0 to 1 transition) at the enable input En (Enable) triggers the on-delay for the random generator. The negative edge (1 to 0 transition) triggers the off-delay for the random generator.
Parameter	T_H : The on-delay is determined at random and lies between 0 s and T_H . T_L : The off-delay is determined at random and lies between 0 s and T_L .
Output Q	Q is set on expiration of the on-delay if En is still set. It is reset when the off-delay time has expired and if En has not been set again.

Parameters **T_H** and **T_L**

The on-delay time **T_H** and the off-delay time **T_L** can be provided by the actual value of another already-programmed function:

- Analog comparator: Ax - Ay
- Analog threshold trigger: Ax
- Analog amplifier: Ax
- Analog multiplexer: AQ
- Analog ramp: AQ
- Mathematic instruction: AQ
- PI controller: AQ
- Up/Down counter: Cnt

For the **OBA7** and **OBA8** devices, you can additionally use the actual values of the following already-programmed functions:

- On-delay: Ta
- Off-delay: Ta
- On-/off-delay: Ta
- Retentive on-delay: Ta
- Wiping relay(pulse output): Ta
- Edge triggered wiping relay: Ta
- Asynchronous pulse generator: Ta
- Stairway light switch: Ta

- Multiple function switch: Ta
- Stopwatch: AQ
- Analog filter: AQ
- Average value: AQ
- Max/Min: AQ
- Threshold trigger: Fre

You select the required function by the block number.

Timing diagram

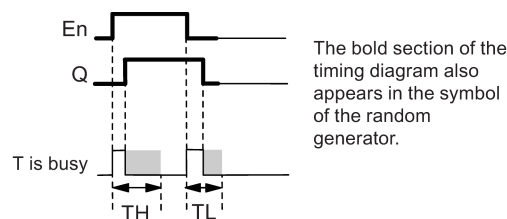

Description of the function

With the 0 to 1 transition at input En, a random time (on-delay time) between 0 s and T_H is set and triggered. If the status at input En is 1 for at least the duration of the on-delay, the output is set to 1 when this on-delay time has expired.

The time is reset if the status at input En is reset to 0 before the on-delay time has expired.

When input En is reset 0, a random time (off-delay time) between 0 s and T_L is set and triggered.

If the status at input En is 0 at least for the duration of the off-delay time, the output Q is reset to 0 when the off-delay time has expired.

The time is reset if the status at input En returns to 1 before the on-delay time has expired.

Special functions (Page 212)

5.3.1.10 Stairway lighting switch

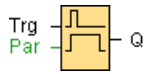

Short description

The edge of an input pulse triggers a configurable time. The output is reset when this time has expired. An off warning can be output prior to the expiration of this time.

Connection	Description
Input Trg	You trigger the time (off-delay) for the stairway switch with a signal at input Trg (Trigger).
Parameter	T : The output is reset (1 to 0 transition) when the off-delay time T has expired. T_I : determines the triggering time for the prewarning. T_{IL} : determines the length of the prewarning time. Retentivity on = the status is retentive in memory.
Output Q	Q is reset after the time T has expired. A warning signal can be output before this time has expired.

Parameters T, T_I and T_{IL}

The off-delay time T, the prewarning time T_I and the prewarning period T_{IL} can be provided by the actual value of another already-programmed function:

- Analog comparator: Ax - Ay
- Analog threshold trigger: Ax
- Analog amplifier: Ax
- Analog multiplexer: AQ
- Analog ramp: AQ
- Mathematic instruction: AQ
- PI controller: AQ
- Up/Down counter: Cnt

For the **OBA7** and **OBA8** devices, you can additionally use the actual values of the following already-programmed functions:

- On-delay: Ta
- Off-delay: Ta
- On-/off-delay: Ta
- Retentive on-delay: Ta
- Wiping relay(pulse output): Ta
- Edge triggered wiping relay: Ta
- Asynchronous pulse generator: Ta
- Stairway light switch: Ta

- Multiple function switch: Ta
- Stopwatch: AQ
- Analog filter: AQ
- Average value: AQ
- Max/Min: AQ
- Threshold trigger: Fre

You select the required function by the block number.

Timing diagram

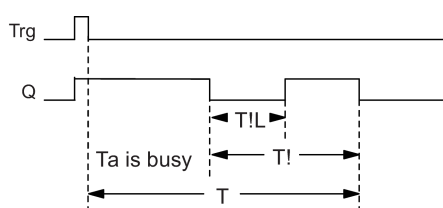

The prewarning time is set to 15 s. The T_1 and T_{IL} parameters thus become obsolete.

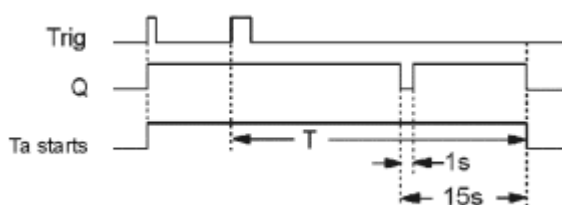

Changing the time base

You can change the prewarning time base and the period.

Time base T	Prewarning time	Prewarning period
Seconds *	750 ms	50 ms
Minutes	15 s	1 s
Hours	15 min	1 min

* makes sense only for programs with a cycle time of < 25 ms

Description of the function

Output Q is set to 1 with a 0 to 1 signal transition at input Trg. The 1 to 0 transition at input Trg triggers the current time and output Q remains set.

Output Q is reset to 0 when Ta reaches the time T. Before the off delay time (T - Ti) has expired, you can output a prewarning that resets Q for the duration of the off prewarning time T_{IL}.

Ta is retrigged (optional) at the next high/low transition at input Trg and if Ta is expiring.

Scan cycle time

For information on how to determine the scan cycle time of a LOGO!, refer to the appendix of the *LOGO! Manual*.

Special functions (Page 212)

5.3.1.11 Multiple function switch

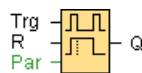

Short description

Switch with two different functions:

- Pulse switch with off delay
- Switch (continuous light)

Connection	Description
Input Trg	A signal at input Trg (Trigger) sets output Q (permanent light) or resets Q with an off-delay. When active, output Q can be reset with a signal at input Trg .
Input R	A signal at input R resets the current time Ta and resets the output.
Parameter	T : determines the off-delay time. The output is reset (1 to 0 transition) when the time T expires. T_L : determines the period during which the input must be set in order to enable the permanent light function. T_I : determines the on delay for the prewarning time. T_{IL} : determines the length of the prewarning time period. Retentivity on = the status is retentive in memory.
Output Q	Output Q is set with a signal at input Trg , and it is reset again after a configured time has expired and depending on the pulse width at input Trg , or it is reset with another signal at input Trg .

Parameters T , T_L , T_I and T_{IL}

The off-delay time T , the permanent light time T_L , the on-delay prewarning time T_I , and the prewarning time period T_{IL} can be provided by the actual value of another already-programmed function:

- Analog comparator: Ax - Ay
- Analog threshold trigger: Ax
- Analog amplifier: Ax
- Analog multiplexer: AQ
- Analog ramp: AQ
- Mathematic instruction: AQ
- PI controller: AQ
- Up/Down counter: Cnt

For the **OBA7** and **OBA8** devices, you can additionally use the actual values of the following already-programmed functions:

- On-delay: Ta
- Off-delay: Ta
- On-/off-delay: Ta
- Retentive on-delay: Ta
- Wiping relay(pulse output): Ta
- Edge triggered wiping relay: Ta
- Asynchronous pulse generator: Ta
- Stairway light switch: Ta
- Multiple function switch: Ta
- Stopwatch: AQ
- Analog filter: AQ
- Average value: AQ
- Max/Min: AQ
- Threshold trigger: Fre

You select the required function by the block number.

Timing diagram

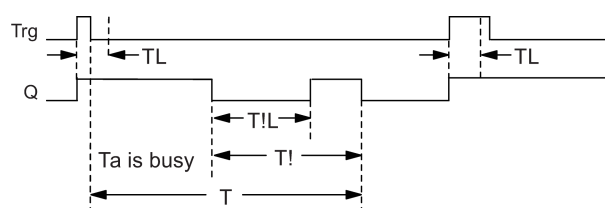



OBA2, OBA3:

Only the T_L and T parameters exist.

The output is reset when T has expired.

T_L determines the period during which the input must be set in order to enable the permanent light function.

Input R is not available to the user.

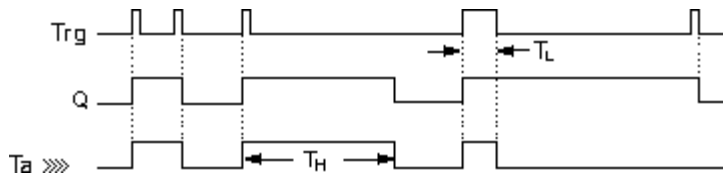

Description of the function

Output Q is set to 1 with a 0 to 1 signal transition at Trg .

If output $Q = 0$, and input Trg is set hi for at least the duration of T_L , the permanent lighting function is enabled and output Q is set accordingly.

The off-delay time T is triggered when the status at input Trg changes to 0 before the time T_L has expired.

Output Q is reset when the $Ta = T$.

You can output an off-warning signal prior to the expiration of the off-delay time ($T - T_i$) that resets Q for the duration of the off prewarning time T_{iL} . A subsequent signal at input Trg always resets T and output Q .

Caution

The time base for T , T_i and T_{iL} must be identical.

Special functions (Page 212)

5.3.1.12 Weekly timer

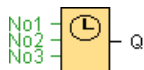

Caution

Your LOGO! must be equipped with an internal real-time clock if you are going to use this SFB.

Short description

The output is controlled by means of a configurable on/off date. The function supports any combination of weekdays.

Connection	Description
Parameters No1, No2, No3	At the No1, No2, No3 (Cam) parameters you set the on- and off-time triggers for each cam of the weekly timer. For each Cam you specify the day of the week and the time of day for the on- and off-times.
Par	You specify whether the timer pulses on for one cycle when activated and is then reset. The pulse parameter applies to all three cams.
Output Q	Q is set when the configured cam is actuated.

Timing diagram (three practical examples)

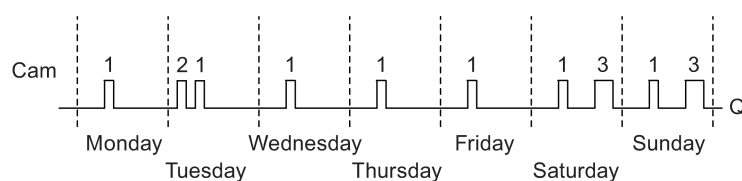

Cam 1:	Daily:	06:30 h to 8:00 h
Cam 2:	Tuesday:	03:10 h to 04:15 h
Cam 3:	Saturday and Sunday:	16:30 h to 23:10 h

Description of the function

Each weekly timer is equipped with three cams. You can configure a time hysteresis for each individual cam. At the cams you set the on- and off-hysteresis. The weekly timer sets the output at a certain time, provided it is not already set.

The weekly timer resets the output at the off-time if you configured an off-time, or at the end of the cycle if you specified a pulse output. A conflict is generated in the weekly timer when the on-time and the off-time at another cam are identical. In this case, cam 3 takes priority over cam 2, while cam 2 takes priority over cam 1.

The switching status of the weekly timer is determined by the status at the No1, No2 and No3 cams.

On-times

The on-time is any time between 00:00 h and 23:59 h. You can also configure the on-time to be a pulse signal. The timer block will be activated at the specified time for one cycle and then the output is reset. The off-time is disabled in this case as it is not applicable.

Special characteristics to note when configuring

The block properties window offers a tab for each one of the three cams. Here you can set the day of the week for each cam. Each tab offers you in addition an option of defining the

on- and off-times for each cam in hour and minute units. Hence, the shortest switching cycle is one minute. Also on each tab you have the option of specifying a pulse output for the cam.

You can disable the on- and off-times individually. You can achieve switching cycles extending across more than one day, for example, by setting the on-time for cam 1 to Monday 7:00 h and the off-time of cam 2 to Wednesday 13:07 h, while disabling the on time for cam 2.

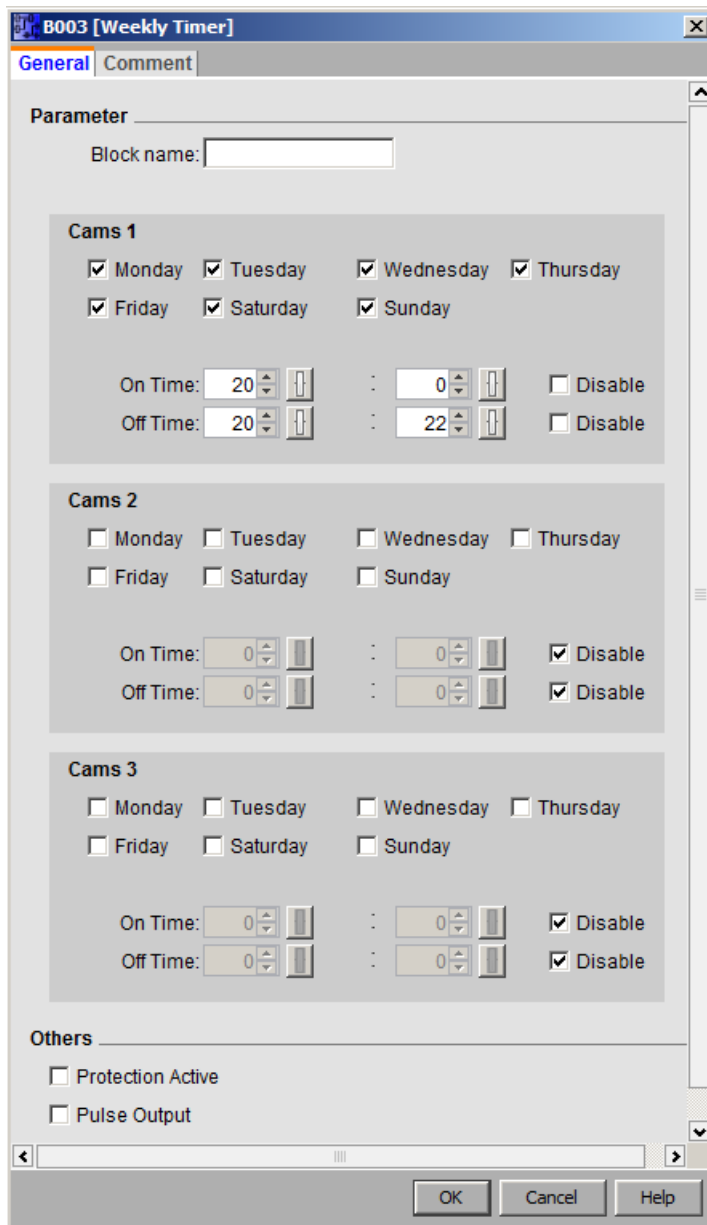

The **Pulse** setting is available only as of the OBA6 device series.

Backup of the real-time clock

The internal real-time clock of LOGO! is buffered against power failure. The buffering time is influenced by the surrounding temperature, and is typically 20 days (for LOGO! 0BA7 devices) or 80 hours (for LOGO! 0BA6 devices) at a surrounding temperature of 25 °C.

The LOGO! 0BA6 devices and higher support the option of a battery card or a combined program module (memory) and battery card. The real-time clock is buffered for several years with either of these cards.

Special functions (Page 212)

5.3.1.13 Yearly timer

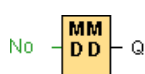

Short description

The output is controlled by means of a configurable on/off date. You can configure the timer to activate on a yearly, monthly, or user-defined time basis. With any mode, you can also configure the timer to pulse the output during the defined time period. The time period is configurable within the date range of January 1, 2000 to December 31, 2099.

Note

To use this function block, you must use a LOGO! with an internal real-time clock.

Connection	Description
Parameter	At the No (cam) parameter, you configure the timer mode, the on-/off-times for the timer, and whether the output is a pulse output.
Output Q	Q is set on when the configured cam is switched on.

Timing diagrams

Example 1: Yearly selected, On Time = 2000.06.01, Off Time = 2099.08.31, Every year on June 1 the timer output switches on and remains on until August 31.

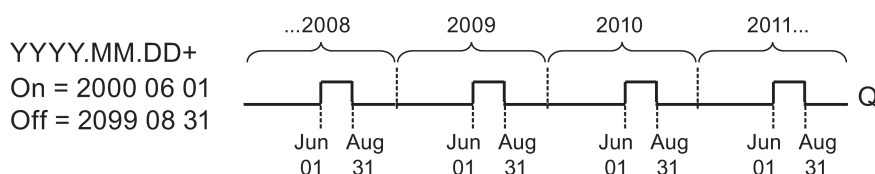

Example 2: Yearly selected, Pulse Output selected, On Time = 2000.03.15, Off Time = 2099..**. Every year on March 15, the timer switches on for one cycle.**

5.3 Special functions

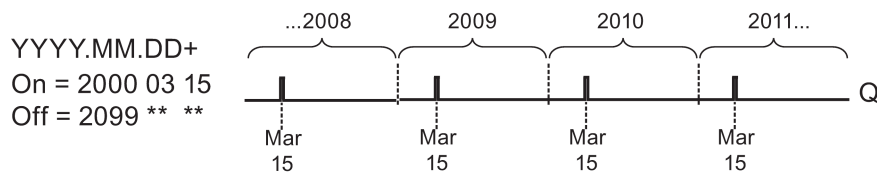

Example 3: Yearly selected, On Time = 2008.06.01, Off Time = 2010.08.31. On June 1 of 2008, 2009, and 2010, the timer output switches on and remains on until August 31.

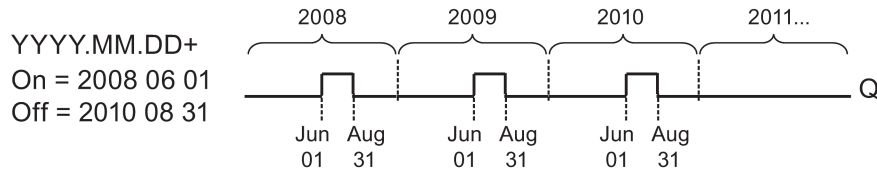

Example 4: Yearly selected, Pulse Output selected, On Time = 2008.03.15, Off Time = 2010..**.** On March 15 of 2008, 2009, and 2010, the timer output switches on for one cycle.

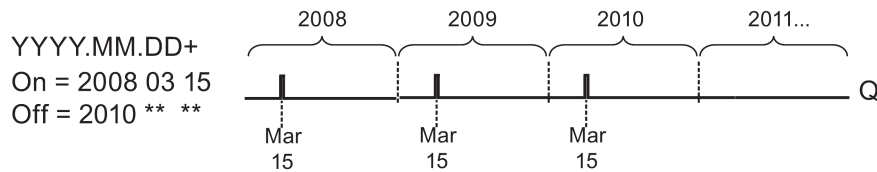

Example 5: Monthly not selected, Yearly not selected, On Time = 2008.06.01, Off Time = 2010.08.31. On June 1, 2008 the timer output switches on and remains on until August 31, 2010.

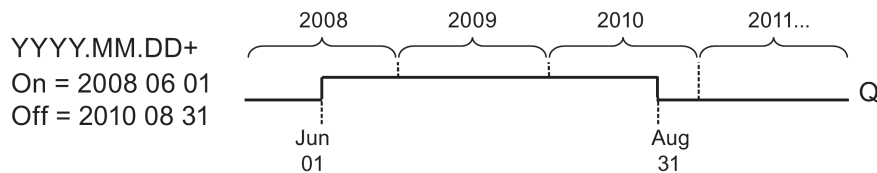

Example 6: Monthly not selected, Yearly not selected, Pulse Output selected, On Time = 2008.03.15, Off Time = **.**.**.** On March 15, 2008 the timer switches on for one cycle. Because the timer does not have a monthly action or yearly action, the timer output pulses only one time at the specified On Time.

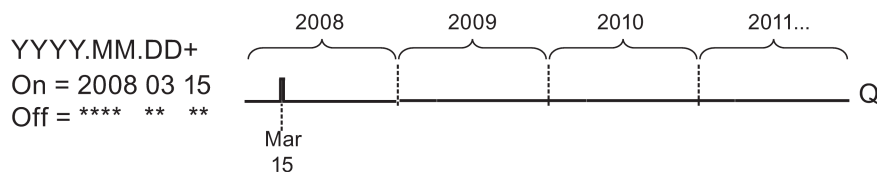

Example 7: Yearly selected, On Time = 2008.12.15, Off Time = 2010.01.07. On December 15 of 2008 and 2009, the timer output switches on and remains on until January 7 of the following year. When the timer output turns off on January 7, 2010 it does NOT turn on again the following December 15.

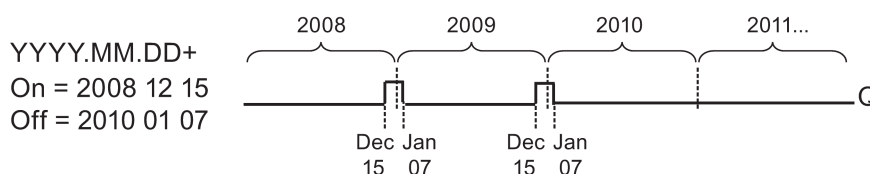

Example 8: Monthly selected, On Time = 2008..01, Off Time = 2010.**.05.** Starting in 2008, on the first day of each month the timer output switches on and switches off on the fifth day of the month. The timer continues in this pattern through the last month of 2010.

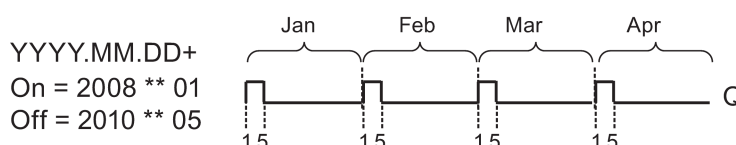

Description of the function

The yearly timer sets and resets the output at specific on and off dates. Sets and resets are executed at 00:00. If your application requires a different time, use a weekly timer together with a yearly timer in your circuit program.

The On Time specifies the month and day when the timer is set. The Off Time identifies the month and day on which the output is reset again. For the on and off times, note the order of the fields: The first field defines the year, the second the month and the third the day.

When you select the **Monthly** check box, the timer output switches on each month at the specified day of the start time and remains on until the specified day of the Off Time. The On Year specifies the initial year in which the timer is activated. The Off Year defines the last year in which the timer turns off. The maximum year is 2099.

If you select the **Yearly** check box, the timer output switches on each year at the specified month and day of the start time and remains on until the specified month and day of the Off Time. The On Year specifies the initial year in which the timer is activated. The Off Year defines the last year in which the timer turns off. The maximum year is 2099.

If you select the **Pulse Output** check box, the timer output switches on at the specified On Time for one cycle and then the timer output is reset. You can choose to pulse a timer on a monthly or yearly basis, or just a single time.

If you select none of the Monthly, Yearly, or Pulse check boxes, you can define a specific time period with the On Time and Off Time. It can span any time period that you choose.

For a process action that is to be switched on and off at multiple but irregular times during the year, you can define multiple yearly timers with the outputs connected by an **OR** function block.



The **Yearly** and **Pulse Output** settings are available only as of the OBA6 device series

The **Monthly** setting is available only as of the OBA4 device series.

Backup of the real-time clock

The internal real-time clock of LOGO! is buffered against power failure. The buffering time is influenced by the surrounding temperature, and is typically 20 days (for LOGO! 0BA7 and 0BA8 devices) or 80 hours (for LOGO! 0BA6 devices) at a surrounding temperature of 25°C. If you are using the optional LOGO! Battery card, or combined LOGO! Memory/Battery card, LOGO! can retain the clock time for up to two years.

Special characteristics to note when configuring

You can numerically enter values for the month and day fields. Enter values within the logical range of month values and day values; otherwise LOGO!Soft Comfort returns an error message.

The **calendar** icon offers you an easy way of setting the date. It opens a window where you can set the days and months by clicking the relevant buttons on a calendar page.

Sample configuration

The output of a LOGO! is to be switched on annually, from the 1st of March to the 4th of April and from the 7th of July to the 19th of November. This requires two blocks for configuring the specific On Times. The outputs are then linked via an OR block.

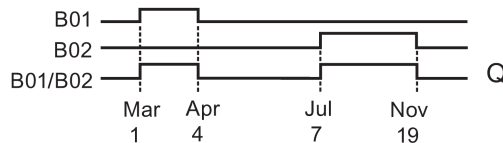

Place two yearly timer switch SFBs on your programming interface. Configure the On Time for the first yearly timer to 03.01 and the Off Time to 04.04. Configure the On Time for the second yearly timer to 07.07 and the Off Time to 11.19.

Create a logical link of the blocks with a standard OR block. The OR output is 1 if at least one of the yearly timer switches is set.

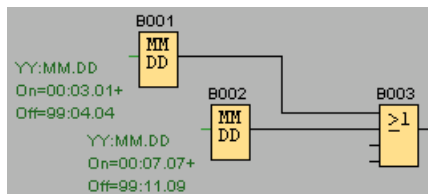

Special functions (Page 212)

5.3.1.14 Astronomical clock (0BA7 and 0BA8 only)



Short description

The astronomical clock SFB is used to set an output high between sunrise and sunset based on the local time at the geographical location of the LOGO! 0BA7 or 0BA8 devices. The output status of this function block also depends on the configuration of summer time/winter time conversion.

Connection	Description
Parameter	The location info including longitude, latitude, time zone, and TR (sunrise time)/ TS (sunset time) offsets.
Output Q	Q is set to hi when sunrise time is reached. It holds this state until sunset time is reached.

Parameters

In the astronomical clock dialog, you can select the location of the LOGO! device from one of the following pre-defined time zone locations:

- Beijing
- Berlin
- London
- Rome
- Moscow
- Tokyo
- Washington
- Ankara
- Madrid
- Amsterdam

If you select one of these locations, LOGO!Soft Comfort uses the latitude, longitude, and time zone of your selection.

Alternatively, you can configure a specific latitude, longitude, and time zone for your location, and provide a name for this custom location.

Based on the location and time zone, LOGO! calculates the absolute sunrise and sunset time for the current day. The block also takes summer time/winter time into consideration, if it is configured on the computer where LOGO!Soft Comfort is installed. To do such configuration, you should select check box of "Automatically adjust clock for daylight for saving changes" in the "Date and Time Properties" dialog.

Timing diagram

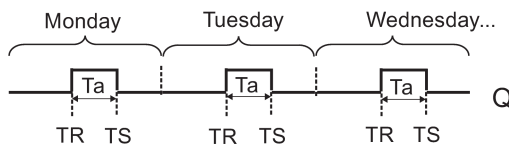

Description of function

The function calculates the value at the input and sets or resets **Q** depending on the sunrise time and sunset time at the configured location and time zone of the module.

Special functions (Page 212)

5.3.1.15 Stopwatch (0BA7 and 0BA8 only)



Short description

The stopwatch records the time elapsed since it was enabled.

Connection	Description
Input En	En (Enable) is the monitoring input. LOGO! sets the current elapsed time to 0 and begins counting elapsed time when En transitions from 0 to 1. When En transitions from 1 to 0, the elapsed time is frozen.
Input Lap	A positive edge (0 to 1 transition) at input Lap pauses the stopwatch, and sets output to lap time. A negative edge (1 to 0 transition) at input Lap resumes the stopwatch, and set the output to current elapsed time.
Input R	A signal at input R (Reset) clears the current elapsed time and lap time.
Parameter	Time base for elapsed time, which you can set to hours, minutes, seconds, or 1/100ths of seconds.
Output AQ	The output AQ outputs value of the current elapsed time when it is a negative edge (1 to 0 transition) at the input Lap , and outputs value of the Lap time when it is a positive edge (0 to 1 transition) at the input Lap . A positive edge (0 to 1 transition) resets the value at output AQ to 0.

Parameters Time base

You can configure the time base for the analog output:

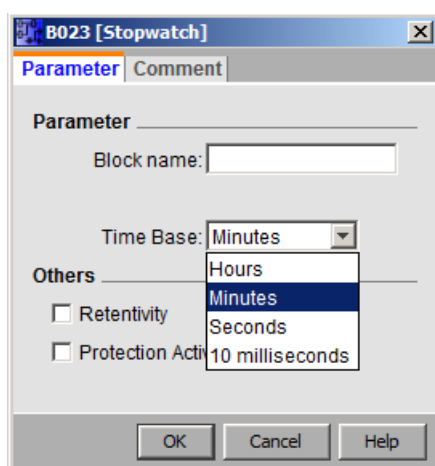

The time base for the elapsed time can be in hours, minutes, seconds, or 1/100ths of seconds (units of 10 milliseconds). The smallest time base, and therefore the resolution, is 10 milliseconds, or 1/100ths of seconds.

Timing diagram

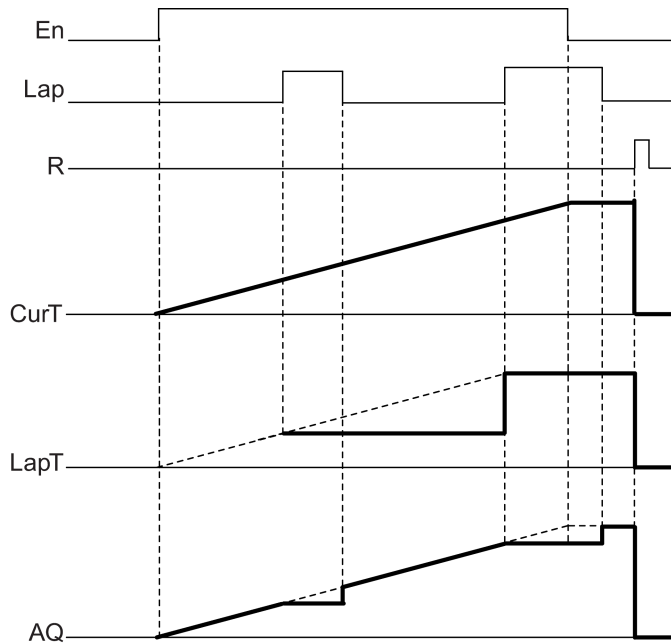

Description of the function

When En = 1, the current time increases.

When En = 0, the current time counting pauses.

When En = 1 and Lap = 0, the output AQ outputs the value of the current elapsed time.

When En = 1 and Lap = 1, the current time continue increasing, but the output AQ outputs the value of the Lap time.

When En = 0 and Lap =1, the output AQ outputs the value of the Lap time.

When En = 0 and Lap = 0, the output AQ outputs the value of the latest current time.

When R = 1, both the current time and the Lap time are reset.

Special functions (Page 212)

5.3.2 Counters

5.3.2.1 Up/Down counter

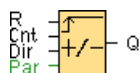

Short description

An input pulse increments or decrements an internal value, depending on the parameter setting. The output is set or reset when a configured threshold is reached. The direction of count can be changed with a signal at input Dir.

Connection	Description
Input R	You reset the output and the internal counter value to the start value (StartVal) with a signal at input R (Reset)
Input Cnt	This function counts the 0 to 1 transitions at input Cnt . It does not count 1 to 0 transitions. <ul style="list-style-type: none"> Use the inputs I3, I4, I5, and I6 for high-frequency counts (LOGO! 12/24RC/RCo, LOGO! 12/24RCE, LOGO! 24/24o and LOGO! 24C/24Co): max. 5 kHz, if the fast input is directly connected to the Up/Down counter function block Use any other input or circuit element for low-frequency counts (typically 4 Hz).
Input Dir	Input Dir (Direction) determines the direction of count: Dir = 0: Up Dir = 1: Down
Parameter	On: On threshold / Value range: 0 to 999999 Off: Off threshold / Value range 0 to 999999 Start Value: Initial value from which to begin counting either down or up. Retentivity on = the status is retentive in memory.
Output Q	Q is set and reset according to the actual value at Cnt and the set thresholds.

Parameters On and Off

The on threshold On and the off threshold Off can be provided by the value of another already-programmed function:

- Analog comparator: Ax - Ay
- Analog threshold trigger: Ax
- Analog amplifier: Ax
- Analog multiplexer: AQ
- Analog ramp: AQ
- Mathematic instruction: AQ

- PI controller: AQ
- Up/Down counter: Cnt

For the **OBA7** and **OBA8** devices, you can additionally use the actual values of the following already-programmed functions:

- On-delay: Ta
- Off-delay: Ta
- On-/off-delay: Ta
- Retentive on-delay: Ta
- Wiping relay(pulse output): Ta
- Edge triggered wiping relay: Ta
- Asynchronous pulse generator: Ta
- Stairway light switch: Ta
- Multiple function switch: Ta
- Stopwatch: AQ
- Analog filter: AQ
- Average value: AQ
- Max/Min: AQ
- Threshold trigger: Fre

You select the required function by the block number.

For information on the validity and accuracy of the time base, refer to the *LOGO! Manual*.

Timing diagram

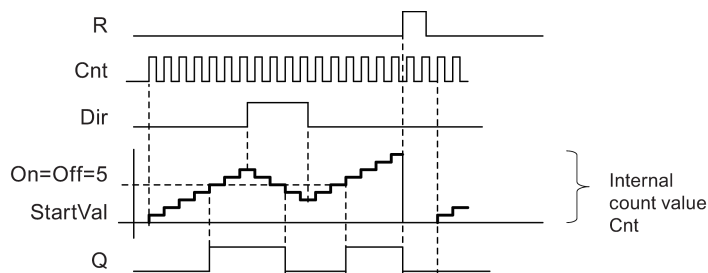

Description of the function

The function increments ($Dir = 0$) or decrements ($Dir = 1$) the internal counter by one count with every positive edge at input Cnt.

You can reset the internal counter value to the start value with a signal at the reset input R. As long as $R=1$, the output Q is 0 and the pulses at input Cnt are not counted.

Output Q is set and reset according to the actual value at Cnt and the set thresholds. See the following rules for calculation.

Calculation rule

- If the on threshold \geq off threshold, then:
Q = 1, if Cnt \geq On
Q = 0, if Cnt < Off.
- If the on threshold < off threshold, then:
Q = 1, if On \leq Cnt < Off.



OBA0-OBA5:

The Start Value parameter does not exist. The counter always counts up or down from 0.

OBA0-OBA3:

The off parameter does not exist. The calculation rule is therefore void.

Caution

The function polls the limit value of the counter once in each cycle.

Thus, if the pulses at the fast inputs I3, I4, I5, or I6 are faster than the scan cycle time, the SFB might not switch until the specified limit has been exceeded.

Example: Up to 100 pulses per cycle can be counted; 900 pulses have been counted so far. On = 950; Off = 10000. The output is set in the next cycle, after the value has reached 1000.

The output would not be set at all if the value Off = 980

Scan cycle time

For information on how to determine the scan cycle time of a LOGO!, refer to the appendix in the LOGO! Manual.

Special functions (Page 212)

5.3.2.2 Hours counter



Short description

A configured time is triggered with a signal at the monitoring input. The output is set when this time has expired.

Connection	Description
Inout R	A positive edge (0 to 1 transition) at input R resets output Q and sets a configured value MI at the counter for the duration of the time-to-go (MN).
Input En	En is the monitoring input. LOGO! scans the On Time of this input.

Input Ral	<p>A positive edge at input Ral (Reset all) resets the hours counter (OT) and the output, and sets the time-to-go value (MN) to the configured maintenance interval (MI):</p> <ul style="list-style-type: none"> • Output Q = 0 • The measured operating hours OT = 0 • The time-to-go of the maintenance interval MN = MI.
Parameter	<p>MI: Maintenance interval to be specified in units of hours and minutes Range of values: 0000 h to 9999 h, 0 m to 59 m</p> <p>OT: Accumulated total operating time. An offset start time can be specified in hours and minutes. Range of values: 00000 h to 99999 h, 0 m to 59 m</p> <p>Q → 0:</p> <ul style="list-style-type: none"> • When "R" is selected: Q = 1, if MN = 0; Q = 0, if R = 1 or Ral = 1 • When "R+En" is selected: Q = 1, if MN = 0; Q = 0, if R = 1 or Ral = 1 or En = 0.
Output Q	<p>The output is set when the time-to-go MN = 0. The output is reset:</p> <ul style="list-style-type: none"> • When "Q → 0:R+En", if R = 1 or Ral = 1 or En = 0 • When "Q → 0:R", if R = 1 or Ral = 1.

Parameter MI

The maintenance interval MI can be provided by the actual value of another already-programmed function:

- Analog comparator: Ax - Ay
- Analog threshold trigger: Ax
- Analog amplifier: Ax
- Analog multiplexer: AQ
- Analog ramp: AQ
- Mathematic instruction: AQ
- PI controller: AQ
- Up/Down counter: Cnt

For the **OBA7** and **OBA8** devices, you can additionally use the actual values of the following already-programmed functions:

- On-delay: Ta
- Off-delay: Ta
- On-/off-delay: Ta
- Retentive on-delay: Ta

- Wiping relay(pulse output): Ta
- Edge triggered wiping relay: Ta
- Asynchronous pulse generator: Ta
- Stairway light switch: Ta
- Multiple function switch: Ta
- Stopwatch: AQ
- Analog filter: AQ
- Average value: AQ
- Max/Min: AQ
- Threshold trigger: Fre

You select the required function by the block number.

Timing diagram

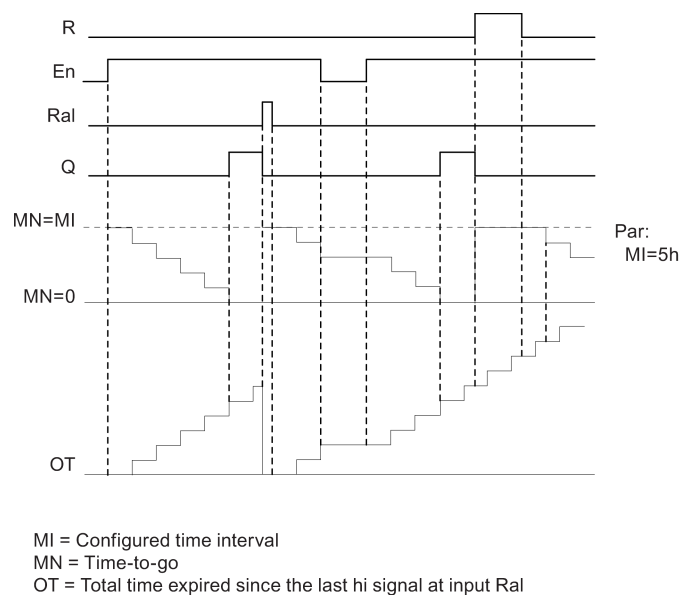

These values are always retentive.

Description of the function

The hours counter monitors input En. As long as the status at this input is 1, LOGO! calculates the expired time and the time-to-go MN. LOGO! displays these times when set to configuration mode. The output is set to 1 when the time-to-go is equal to zero.

You reset output Q and the time-to-go counter to the specified value MI with a signal at input R. The operation hour counter OT remains unaffected.

You reset output Q and the time-to-go counter to the specified value MI with a signal at input Ral. The operation hour counter OT is reset to 0.

Depending on your configuration of the Q parameter, the output is either reset with a reset signal at input R or Ral ("Q → R"), or when the reset signal is 1 or the En signal is 0 ("Q → R+En").

Viewing the MI, MN and OT values

In LOGO!Soft Comfort you can fetch the hours counter via the Tools -> Transfer -> Hours Counter (Page 85) menu command.

Limit value of OT

The value of the operating hours in OT is retained when you reset the hours counter with a signal at input R. The hours counter OT will be reset to zero with a transition from 0 to 1 at Ral. The hours counter OT continues the count as long as En = 1, irrespective of the status at the reset input R. The counter limit of OT is 99999 h. The hours counter stops when it reaches this value.

In programming mode, you can set the initial value of OT. MN is calculated according to the following formula when reset input R is never enabled: $MN = MI - (OT \% MI)$. The % operator provides an integer division remainder.

Example:

$$MI = 30h, OT = 100h$$

$$MN = 30 - (100 \% 30)$$

$$MN = 30 - 10$$

$$MN = 20h$$

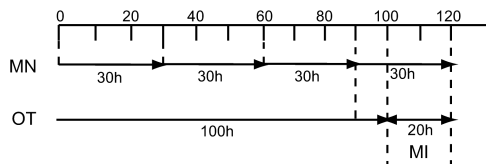

In runtime mode, the value OT cannot be preset. If the value for MI is changed, there would be no calculation for the MN. MN would take on the value of MI.

Parameter preset

In LOGO!Soft Comfort, you can define MI and an OT start value.

You determine that Q does not depend on En by selecting the corresponding check box.

Retentivity with the hours counter

The hours counter in the LOGO! is retentive.

If the values of the hours counter are lost after a power failure, then select the respective block in your circuit program. Right-click the hours counter and select **Block Properties > Parameter**. The option **Retentivity** must be activated and unchangeable (grayed out).

If the **Retentivity** option is not available, then delete the block and insert a new special function **hours counter** at the same position.



OBA0-OBA5:

The maintenance interval (MI) and the start time for the operating time (OT) were in units of hours. These values could not be provided by another function prior to the OBA6 device series.

Value reset

If you download a circuit program that contains an hours counter function from LOGO!Soft Comfort to a LOGO! OBA7 or LOGO! OBA8 Base Module, LOGO!Soft Comfort prompts you whether to continue or not. If you continue with the download, the hours counter value is reset.



Note

If you copy a circuit program that contains an hours counter function from an SD card to a LOGO! Base Module, the hours counter value is reset with no notification.

Special functions (Page 212)

5.3.2.3 Threshold trigger



Short description

The output is switched on and off depending on two configurable frequencies.

Connection	Description
Input Fre	<p>The function counts 0 to 1 transitions at input Fre. Transitions from 1 to 0 are not counted.</p> <ul style="list-style-type: none"> Use the inputs I3, I4, I5, and I6 for high-frequency counts (LOGO! 12/24RC/RCo, LOGO! 12/24RCE, LOGO! 24/24o and LOGO! 24C/24Co): max 5kHz, if the fast input is directly connected to the threshold trigger function block Use any other input or circuit element for low frequencies (typical 4 Hz).

Parameter	<p>On: On threshold Range of values: 0000 to 9999</p> <p>Off: Off threshold Range of values: 0000 to 9999</p> <p>G_T: Time interval or gate time during which the input pulses are measured. Range of values: 00:00 s to 99:99 s</p>
Output Q	Q is set or reset according to the threshold values.

Parameter G_T

The gate time G_T can be provided by the actual value of another already-programmed function:

- Analog comparator: Ax - Ay
- Analog threshold trigger: Ax
- Analog amplifier: Ax
- Analog multiplexer: AQ
- Analog ramp: AQ
- Mathematic instruction: AQ
- PI controller: AQ
- Up/Down counter: Cnt

For the **0BA7** and **0BA8** devices, you can additionally use the actual values of the following already-programmed functions:

- On-delay: Ta
- Off-delay: Ta
- On-/off-delay: Ta
- Retentive on-delay: Ta
- Wiping relay(pulse output): Ta
- Edge triggered wiping relay: Ta
- Asynchronous pulse generator: Ta
- Stairway light switch: Ta
- Multiple function switch: Ta
- Stopwatch: AQ
- Analog filter: AQ
- Average value: AQ
- Max/Min: AQ
- Threshold trigger: Fre

You select the required function by the block number.

Timing diagram

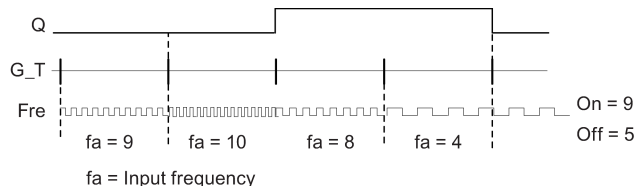

Description of the function

The trigger measures the signals at input Fre. The pulses are captured during a configurable period G_T.

Q is set or reset according to the set thresholds. See the following calculation rule.

Calculation rule

- If the threshold (On) \geq threshold (Off), then:
Q = 1, if $fa > On$
Q = 0, if $fa \leq Off$.
- If the threshold (On) $<$ threshold (Off), then Q = 1, if
 $On \leq fa < Off$.

Special functions (Page 212)

5.3.3 Analog

5.3.3.1 Analog threshold trigger

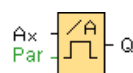

Short description

The output is set or reset depending on two configurable thresholds (hysteresis).

Connetion	Description
Input Ax	<p>Input Ax is one of the following analog signals:</p> <ul style="list-style-type: none"> • AI1 to AI8 (*) • AM1 to AM6 (if 0BA6), AM1 to AM16 (if 0BA7), or AM1 to AM64 (if 0BA8) • NAI1 to NAI32 (if 0BA7 or 0BA8) • AQ1 and AQ2 (if 0BA7), or AQ1 to AQ8 (if 0BA8) • NAQ1 to NAQ16 (if 0BA7 or 0BA8) • The block number of a function with analog output

Parameter	<p>Gain Range of values: -10.00 to 10.00</p> <p>Offset Range of values: -10000 to 10000</p> <p>On: On threshold Range of values: -20000 to 20000</p> <p>Off: Off threshold Range of values: -20000 to 20000</p> <p>p: Number of decimals Range of values: 0, 1, 2, 3</p>
Output Q	Q is set or reset depending on the set thresholds.
* AI1 to AI8: 0 to 10 V corresponds with 0 to 1000 (internal value).	

Parameters On and Off

The On and Off parameters can be provided by the actual value of another already-programmed function:

- Analog comparator: Ax - Ay
- Analog amplifier: Ax
- Analog multiplexer: AQ
- Analog ramp: AQ
- Mathematic instruction: AQ
- PI controller: AQ
- Up/Down counter: Cnt

For the **OBA7** and **OBA8** devices, you can additionally use the actual values of the following already-programmed functions:

- On-delay: Ta
- Off-delay: Ta
- On-/off-delay: Ta
- Retentive on-delay: Ta
- Wiping relay(pulse output): Ta
- Edge triggered wiping relay: Ta
- Asynchronous pulse generator: Ta
- Stairway light switch: Ta
- Multiple function switch: Ta
- Stopwatch: AQ
- Analog filter: AQ
- Average value: AQ
- Max/Min: AQ
- Threshold trigger: Fre

You select the required function by the block number.



OBA4:

A: Gain

Range of values 0.00 to 10.00

OBA2, OBA3:

These parameters apply:

G: Gain in [%]

Range of values 0% to 1000%

O: Offset

Range of values -999 to 999

On: On threshold

Range of values 0 to 9999

Off: Off threshold

Range of values 0 to 9999

Parameter p (number of decimals)

Parameter p applies only to the display of On, Off and Ax values in a message text.

Parameter p does not apply to the comparison of On and Off values. (The compare function ignores the decimal point.)

Timing diagram

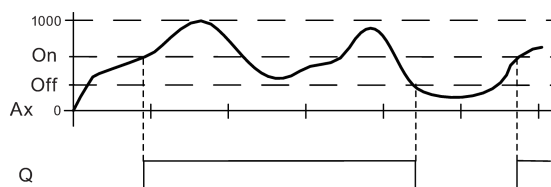

Description of the function

The function reads the value of the signal at the analog input Ax.

This value is multiplied by the value of parameter A (gain). Parameter B (offset) is added to the product, hence

$$(Ax * Gain) + Offset = Actual\ value\ Ax.$$

Output Q is set or reset depending on the set threshold values. See the following calculation rule.



OBA2, OBA3:

The **function** is as follows:

The offset parameter is added to the read analog value. The sum is multiplied by the value of the gain parameter.

$$\text{Value} = (AI + \text{offset}) * \text{gain}$$

Output Q is set to 1 if the calculated value exceeds the on threshold (TH high).

Q is reset to 0 when the value reaches or drops below the off threshold (TH low).

Calculation rule

- If threshold (On) \geq threshold (Off), then:
Q = 1, if the actual value $A_x > \text{On}$
Q = 0, if the actual value $A_x \leq \text{Off}$.
- If threshold (On) $<$ threshold (Off), then Q = 1, if
 $\text{On} \leq$ the actual value $A_x < \text{Off}$.

Particular characteristics to be noted when configuring

Refer to the help on analog block parameters in the Analog value processing (Page 286) section.

The screenshot shows the configuration window for the B003 [Analog threshold trigger] block. The window has a title bar with the text "B003 [Analog threshold trigger]" and a close button. Below the title bar are two tabs: "Parameter" (selected) and "Comment".

The main configuration area is divided into several sections:

- Parameter:** A text input field for "Block name:".
- Sensor:** A dropdown menu for "Sensor:" with the value "0 ... 10 V" selected.
- Analog Setting:** This section is further divided into two sub-sections:
 - Measurement Range:** Contains two input fields: "Minimum:" with the value "0" and "Maximum:" with the value "1000".
 - Parameter:** Contains two input fields: "Gain:" with the value "1.00" and "Offset:" with the value "0".
- Threshold:** This section has two sub-sections:
 - On:** An input field with the value "0".
 - Off:** An input field with the value "0".
- Decimal Places:** An input field for "Decimal places in the message text:" with the value "0" and a label "+12345" to its right.
- Others:** A checkbox labeled "Protection Active" which is currently unchecked.

At the bottom of the dialog box are three buttons: "OK", "Cancel", and "Help".

Note

The decimal point setting must be identical in the minimum and maximum range.

5.3.3.2 Analog differential trigger

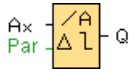

Short description

The output is set and reset depending on a configurable threshold and a differential value.

Connection	Description
Input Ax	Input Ax is one of the following analog signals: <ul style="list-style-type: none"> • AI1 to AI8 (*) • AM1 to AM6 (if 0BA6), AM1 to AM16 (if 0BA7), or AM1 to AM64 (if 0BA8) • NAI1 to NAI32 (if 0BA7 or 0BA8) • AQ1 and AQ2 (if 0BA7), or AQ1 to AQ8 (if 0BA8) • NAQ1 to NAQ16 (if 0BA7 or 0BA8) • The block number of a function with analog output
Parameter	Gain Range of values: -10.00 to 10.00 Offset Range of values: -10000 to 10000 On: On/Off threshold Range of values: -20000 to 20000 Δ: Differential value for calculating the off parameter Range of values: -20000 to 20000 p: Number of decimals Range of values: 0, 1, 2, 3
Output Q	Q is set or reset, depending on the threshold and difference values.
* AI1 to AI8: 0 to 10 V corresponds with 0 to 1000 (internal value).	



A: Gain
 Range of values: 0.00 to 10.00

Parameter p (number of decimals)

Parameter p applies only to the display of On, Off and Ax values in a message text.

Parameter p does not apply to the comparison of On and Off values. (The compare function ignores the decimal point.)

Timing diagram A: Function with negative difference Delta

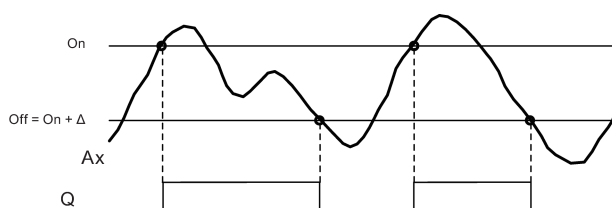

Timing diagram B: Function with positive difference Delta

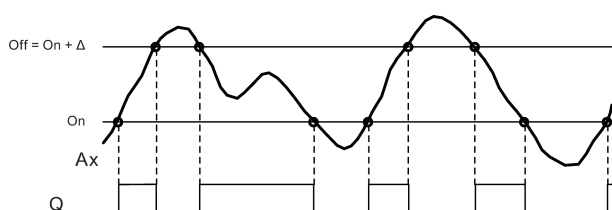

Description of the function

The function fetches the analog signal at input A_x .

A_x is multiplied by the value of the A (gain) parameter, and the value at parameter B (offset) is added to product, i.e.

$(A_x * \text{gain}) + \text{offset} = \text{actual value of } A_x$.

Output Q is set or reset, depending on the set (On) threshold and difference value (Δ). The function automatically calculates the Off parameter: $Off = On + \Delta$, whereby Δ may be positive or negative. See the calculation rule below.

Calculation rule

- When you set a negative differential value Δ , the On threshold \geq Off threshold, and:
 $Q = 1$, if the actual value $A_x > On$
 $Q = 0$, if the actual value $A_x \leq Off$.
See the timing diagram A.
- When you set a positive differential value Δ , the On threshold $<$ the Off threshold, and
 $Q = 1$, if:
 $On \leq \text{the actual value } A_x < Off$.
See the timing diagram B.

Particular characteristics to be noted when configuring

Refer to the help on analog block parameters in the Information on analog value processing (Page 286) section.

Special functions (Page 212)

5.3.3.3 Analog comparator



Short description

The output is set and reset depending on the difference $A_x - A_y$ and on two configurable thresholds.

Connection	Description
Inputs Ax, Ay	Inputs Ax, Ay are two analog signals from the followings: <ul style="list-style-type: none"> • AI1 to AI8 (*) • AM1 to AM6 (if OBA6), AM1 to AM16 (if OBA7), or AM1 to AM64 (if OBA8) • NAI1 to NAI32 (if OBA7 or OBA8) • AQ1 and AQ2 (if OBA7), or AQ1 to AQ8 (if OBA8) • NAQ1 to NAQ16 (if OBA7 or OBA8) • The block number of a function with analog output
Parameter	Gain Range of values: -10.00 to 10.00 Offset Range of values: -10000 to 10000 On: On threshold Range of values: -20000 to 20000 Off: Off threshold Range of values: -20000 to 20000 p: Number of decimals Range of values: 0, 1, 2, 3
Output Q	Q is set or reset depending on the set thresholds.
* AI1 to AI8: 0 to 10 V corresponds with 0 to 1000 (internal value).	



OBA4:

A: Gain

Range of values: 0.00 to 10.00

OBA0-OBA3:

The following parameters apply:

G : Gain in [%]

Range of values: 0% to 1000%

O : Offset

Range of values: -999 to 999

delta : Threshold

Q is set to 1 when the difference $A_x - A_y$ exceeds the threshold.

Parameters On and Off

The on threshold On and the off threshold Off can be provided by the actual value of another already-programmed function:

- Analog threshold trigger: Ax
- Analog amplifier: Ax
- Analog multiplexer: AQ
- Analog ramp: AQ
- Mathematic instruction: AQ
- PI controller: AQ
- Up/Down counter: Cnt

For the **OBA7** and **OBA8** devices, you can additionally use the actual values of the following already-programmed functions:

- On-delay: Ta
- Off-delay: Ta
- On-/off-delay: Ta
- Retentive on-delay: Ta
- Wiping relay(pulse output): Ta
- Edge triggered wiping relay: Ta
- Asynchronous pulse generator: Ta
- Stairway light switch: Ta
- Multiple function switch: Ta
- Stopwatch: AQ
- Analog filter: AQ
- Average value: AQ
- Max/Min: AQ
- Threshold trigger: Fre

You select the required function by the block number.

Parameter p (number of decimals)

Parameter p applies only to Ax, Ay, Delta, On and Off values displayed in a message text.

Parameter p does not apply to the comparison of on and off values. (The compare function ignores the decimal point.)

Timing diagram

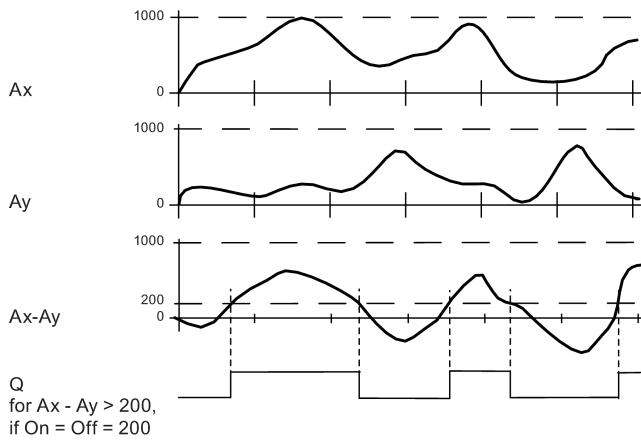

Description of the function

The function reads the value of the signal at the analog input Ax.

This value is multiplied by the value of parameter A (gain). Parameter B (offset) is added to the product, hence

$$(Ax * gain) + offset = \text{Actual value Ax.}$$

$$(Ay * gain) + offset = \text{Actual value Ay.}$$

Output Q is set or reset depending on the difference of the actual values Ax – Ay and the set thresholds. See the following calculation rule.

Calculation rule

- If threshold On \geq threshold Off, then:
Q = 1, if (actual value Ax - actual value Ay) > On
Q = 0, if (actual value Ax - actual value Ay) \leq Off.
- If threshold On < threshold Off, then Q = 1, then:
On \leq (actual value Ax - actual value Ay) < Off.



OBA2, OBA3:

The following **functions/calculation rules** apply:

The function adds the relevant specified offset to the analog values Ax and Ay. The sum is multiplied with the value of the gain parameter. The difference is formed from both calculated values.

Output Q is set if this difference between these values exceeds the threshold you have configured under delta.

Calculation rule:

Q = 1, if:

$$((Ax + offset) * gain) - ((Ay + offset) * gain) > \text{threshold delta}$$

Q is reset to 0 when the threshold reaches or drops below delta.

Reducing the input sensitivity of the analog comparator

You can delay the output of the analog comparator selectively by means of the "on delay" and "off delay" SFBs. By doing so, you determine that output Q is only set if the input trigger length Trg (= output of the analog comparator) exceeds the defined on delay time.

This way you can set a virtual hysteresis, which renders the input less sensitive to short changes.

Particular characteristics to be noted when configuring

For help on analog block parameters, refer to the Analog value processing (Page 286) section.

Special functions (Page 212)

5.3.3.4 Analog watchdog

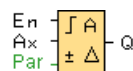

Short description

This special function saves the process variable of an analog input to memory, and sets the output when the output variable exceeds or drops below this stored value plus a configurable offset.

Connection	Description
Input En	A positive edge (0 to 1 transition) at input En saves the analog value at input Ax ("Aen") to memory and starts monitoring of the analog range Aen +- Delta.
Input Ax	Input Ax is one of the following analog signals: <ul style="list-style-type: none"> • AI1 to AI8 (*) • AM1 to AM6 (if 0BA6), AM1 to AM16 (if 0BA7), or AM1 to AM64 (if 0BA8) • NAI1 to NAI32 (if 0BA7 or 0BA8) • AQ1 and AQ2 (if 0BA7), or AQ1 to AQ8 (if 0BA8) • NAQ1 to NAQ16 (if 0BA7 or 0BA8) • The block number of a function with analog output
Parameter	<p>Gain Range of values: -10.00 to 10.00</p> <p>Offset Range of values: -10000 to 10000</p> <p>Threshold 1: Difference value above Aen: on/off threshold Range of values: 0 to 20000</p> <p>Threshold 2: Difference value below Aen: on/off threshold Range of values: 0 to 20000</p> <p>p: Number of decimals Possible settings: 0, 1, 2, 3</p> <p>Retentivity on = the status is retentive in memory.</p>

Output Q	Q is set/reset, depending on the stored analog value and the offset.
* AI1 to AI8: 0 to 10 V corresponds with 0 to 1000 (internal value).	

Parameters Threshold 1 and Threshold 2

The two threshold parameters Threshold 1 and Threshold 2 can be provided by the actual value of another already-programmed function:

- Analog comparator: Ax - Ay
- Analog threshold trigger: Ax
- Analog amplifier: Ax
- Analog multiplexer: AQ
- Analog ramp: AQ
- Mathematic instruction: AQ
- PI controller: AQ
- Up/Down counter: Cnt

For the **OBA7** and **OBA8** devices, you can additionally use the actual values of the following already-programmed functions:

- On-delay: Ta
- Off-delay: Ta
- On-/off-delay: Ta
- Retentive on-delay: Ta
- Wiping relay(pulse output): Ta
- Edge triggered wiping relay: Ta
- Asynchronous pulse generator: Ta
- Stairway light switch: Ta
- Multiple function switch: Ta
- Stopwatch: AQ
- Analog filter: AQ
- Average value: AQ
- Max/Min: AQ
- Threshold trigger: Fre

You select the required function by the block number.

The thresholds are represented by the symbol Δ on the LOGO! Base Module and in the timing diagram below.



OBA4:

Gain: Range of values: 0.00 to 10.00

Parameter p (number of decimals)

Parameter p applies only to the display of Aen, Ax, Threshold 1 and Threshold 2 values in a message text.

Timing diagram

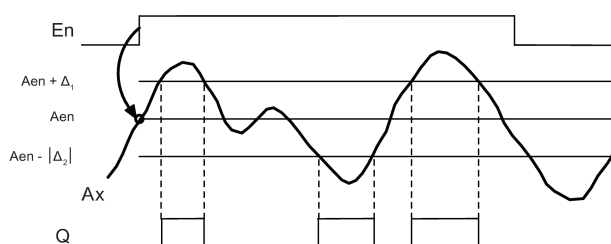

Description of the function

A 0 to 1 transition at input En saves the value of the signal at the analog input Ax. This saved process variable is referred to as "Aen".

Both the analog actual values Ax and Aen are multiplied by the value at parameter A (gain), and parameter B (offset) is then added to the product, as follows:

$(Ax * gain) + offset = \text{Actual value Aen, when input En changes from 0 to 1, or}$

$(Ax * gain) + offset = \text{Actual value Ax.}$

Output Q is set when the signal at input En = 1 and if the actual value at input Ax is out of range of Aen + Threshold 1 / Aen - Threshold 2.

Output Q is reset, when the actual value at input Ax lies within the range of Aen + Threshold 1 / Aen - Threshold 2, or when the signal at input En changes to 0.

Particular characteristics to be noted when configuring

Refer to the help on analog block parameters in the Analog value processing (Page 286) section.

Special functions (Page 212)

5.3.3.5 Analog amplifier

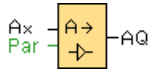

Short description

This SFB amplifies an analog input value and returns it at the analog output.

Connections	Description
Input Ax	Input Ax is one of the following analog signals: <ul style="list-style-type: none"> • AI1 to AI8 (*) • AM1 to AM6 (if OBA6), AM1 to AM16 (if OBA7), or AM1 to AM64 (if OBA8) • NAI1 to NAI32 (if OBA7 or OBA8) • AQ1 and AQ2 (if OBA7), or AQ1 to AQ8 (if OBA8) • NAQ1 to NAQ16 (if OBA7 or OBA8) • The block number of a function with analog output
Parameter	Gain Range of values: -10.00 to 10.00 Offset Range of values: -10000 to 10000 p : Number of decimals Possible settings: 0, 1, 2, 3
Output AQ	Value range for AQ: -32768 to +32767
* AI1 to AI8: 0 to 10 V corresponds with 0 to 1000 (internal value).	



OBA4:

A: Gain

Range of values: 0.00 to 10.00

Parameter p (number of decimals)

Parameter p applies only to the display of Ax and Ay values in a message text.

Parameter p does not apply to the comparison of On and Off values. (The compare function ignores the decimal point.)

Description of the function

The function reads the value of an analog signal at the analog input Ax.

This value is multiplied by the gain parameter A. Parameter B (offset) is added to the product, as follows:

$$(Ax * gain) + offset = \text{Actual value Ax.}$$

The actual value Ax is output at AQ.

Particular characteristics to be noted when configuring

For help on analog block parameters, refer to the Analog value processing (Page 286) section.

Analog output

If you connect this special function to a real analog output, then note that the analog output can only process values from 0 to 1000. To do this, connect an additional amplifier between the analog output of the special function and the real analog output. With this amplifier you standardize the output range of the special function to a value range of 0 to 1000.

Example: additional amplifier behind an analog multiplexer.

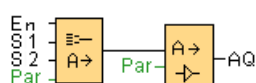

Special functions (Page 212)

5.3.3.6 Analog multiplexer

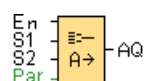

Short description

When enabled, the analog multiplexer SFB displays one of four pre-defined analog values, depending on input conditions.

Connection	Description
Input En	1 on input En (Enable) switches, dependent on S1 and S2, a parameterized analog value to the output AQ. 0 on input EN switches 0 to the output AQ.
Inputs S1 and S2	S1 and S2 (selectors) for selecting the analog value to be issued. S1 = 0 and S2 = 0: The value V1 is issued S1 = 0 and S2 = 1: The value V2 is issued S1 = 1 and S2 = 0: The value V3 is issued S1 = 1 and S2 = 1: The value V4 is issued
Parameter	V1 to V4 : Analog values (Value) that will be issued. Value range: -32768 to +32767 p : Number of decimal places Possible settings: 0, 1, 2, 3
Output AQ	Analog output Value range for AQ: -32768 to +32767

Parameters V1 to V4

The values for V1 to V4 can be provided by the value of another already-programmed function:

- Analog comparator: Ax - Ay
- Analog threshold trigger: Ax
- Analog multiplexer: AQ
- PI controller: AQ
- Analog Ramp: AQ
- Mathematic instruction: AQ
- Up/Down counter: Cnt

For the **OBA7** and **OBA8** devices, you can additionally use the actual values of the following already-programmed functions:

- On-delay: Ta
- Off-delay: Ta
- On-/off-delay: Ta
- Retentive on-delay: Ta
- Wiping relay(pulse output): Ta
- Edge triggered wiping relay: Ta
- Asynchronous pulse generator: Ta
- Stairway light switch: Ta
- Multiple function switch: Ta
- Stopwatch: AQ
- Analog filter: AQ
- Average value: AQ
- Max/Min: AQ
- Threshold trigger: Fre

You select the required function by the block number.

Parameter p (number of decimal places)

Parameter p applies only to the display of AQ, V1, V2, V3 and V4 values in a message text.

Timing diagram

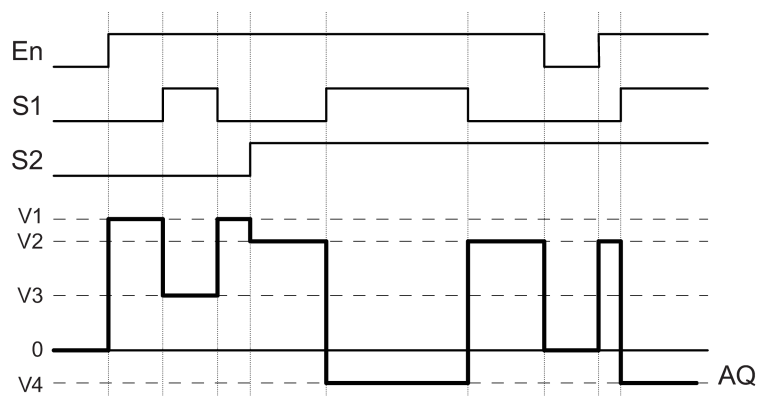

Description of function

If input En is set, then the function issues one of four possible analog values V1 to V4 at the output AQ, depending on the inputs S1 and S2.

If the input En is not set, then the function issues the analog value 0 at output AQ.

Particular characteristics to be noted when configuring

For help on analog block parameters, refer to the Basics (Page 286) section.

Analog output

If you connect this special function to a real analog output, then note that the analog output can only process values from 0 to 1000. To do this, connect an additional amplifier between the analog output of the special function and the real analog output. With this amplifier you standardize the output range of the special function to a value range of 0 to 1000.

Example: additional amplifier behind an analog multiplexer.

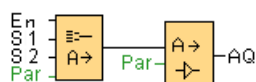

Special functions (Page 212)

See also

Analog comparator (Page 262)
Analog threshold trigger (Page 255)
Analog ramp (Page 304)
Mathematic instruction (Page 276)
PI controller (Page 300)
Up/Down counter (Page 247)
On-delay (Page 217)
Off-delay (Page 218)
On-/Off-delay (Page 220)
Retentive on-delay (Page 222)
Wiping relay (pulse output) (Page 224)
Edge triggered wiping relay (Page 225)
Asynchronous pulse generator (Page 228)
Stairway lighting switch (Page 232)
Multiple function switch (Page 234)
Stopwatch (0BA7 and 0BA8 only) (Page 245)
Analog filter (0BA7 and 0BA8 only) (Page 279)
Average value (0BA7 and 0BA8 only) (Page 285)
Max/Min (0BA7 and 0BA8 only) (Page 280)

5.3.3.7 Pulse Width Modulator (PWM)

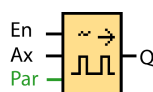

Short description

The Pulse Width Modulator (PWM) instruction modulates the analog input value A_x to a pulsed digital output signal. The pulse width is proportional to the analog value A_x .

Connection	Description
Input En	A positive edge (0 to 1 transition) at input En enables the PWM function block.
Input Ax	Analog signal to be modulated to a pulsed digital output signal.
Parameter	Gain Range of values: -10.00 to 10.00 Offset Range of values: -10,000 to 10,000 PT : Periodic time over which the digital output is modulated p : Number of decimals Possible settings: 0, 1, 2, 3
Output Q	Q is set or reset for the proportion of each time period according to the proportion of the standardized value A_x to the analog value range.



OBA1- OBA5:

The PWM function block did not exist prior to OBA6.

Parameter PT

The periodic time PT can be provided by the actual value of another already-programmed function:

- Analog comparator: $A_x - A_y$
- Analog threshold trigger: A_x
- Analog amplifier: A_x
- Analog multiplexer: AQ
- Analog ramp: AQ
- Mathematic instruction: AQ
- PI controller: AQ
- Up/Down counter: Cnt

For the **OBA7** and **OBA8** devices, you can additionally use the actual values of the following already-programmed functions:

- On-delay: Ta
- Off-delay: Ta
- On-/off-delay: Ta
- Retentive on-delay: Ta
- Wiping relay(pulse output): Ta
- Edge triggered wiping relay: Ta
- Asynchronous pulse generator: Ta
- Stairway light switch: Ta
- Multiple function switch: Ta
- Stopwatch: AQ
- Analog filter: AQ
- Average value: AQ
- Max/Min: AQ
- Threshold trigger: Fre

You select the required function by the block number.

Parameter p (number of decimals)

Parameter p applies only to the display of the Ax value in a message text.

Description of the function

The function reads the value of the signal at the analog input Ax.

This value is multiplied by the value of parameter A (gain). Parameter B (offset) is added to the product, as follows:

$$(Ax * Gain) + Offset = Actual\ value\ Ax$$

The function block calculates the proportion of the value Ax to the range. The block sets the digital output Q high for the same proportion of the PT (periodic time) parameter, and sets Q low for the remainder of the time period.

Examples with Timing Diagrams

The following examples show how the PWM instruction modulates a digital output signal from the analog input value:

Example 1

Analog input value: 500 (range 0 to 1000)

Periodic time T: 4 seconds

The digital output of the PWM function is 2 seconds high, 2 seconds low, 2 seconds high, 2 seconds low and continues in that pattern as long as parameter "En" = high.

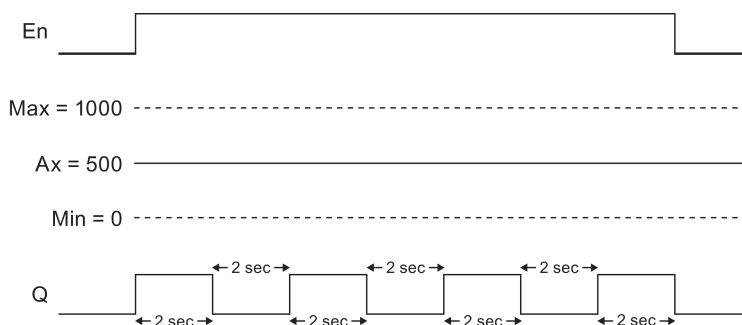

Example 2

Analog input value: 300 (range 0 to 1000)

Periodic time T: 10 seconds

The digital output of the PWM function is 3 seconds high, 7 seconds low, 3 seconds high, 7 seconds low and continues in that pattern as long as parameter "En" = high.

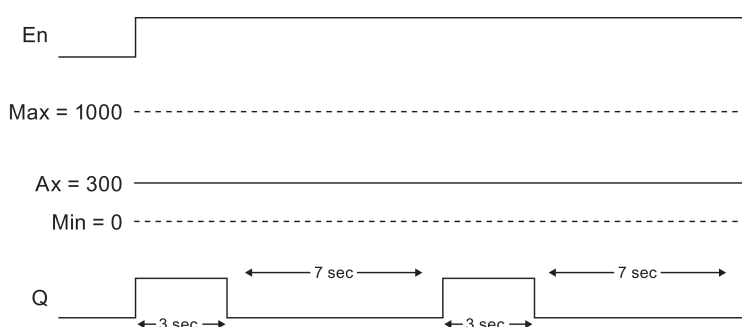

Calculation rule

$Q = 1$, for $(Ax - Min) / (Max - Min)$ of time period PT

$Q = 0$, for $PT - [(Ax - Min) / (Max - Min)]$ of time period PT.

Note: Ax in this calculation refers to the actual value Ax as calculated using the Gain and Offset. Min and Max refer to the minimum and maximum values specified for the range.

Particular characteristics to be noted when configuring

Refer to the help on analog block parameters in the Analog value processing (Page 286) section.

Special functions (Page 212)

5.3.3.8 Mathematic instruction

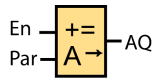

Short description

The mathematic instruction block calculates the value AQ of an equation formed from the user-defined operands and operators.

Connection	Description
Input En	A positive edge at input En enables the mathematic instruction function block
Parameter	<p>V1: Value 1: First operand V2: Value 2: Second operand V3: Value 3: Third operand V4: Value 4: Fourth operand Range of values: -32768 to 32767</p> <p>Operator 1: First operator Operator 2: Second operator Operator 3: Third operator Priority 1: Priority of first operation Priority 2: Priority of second operation Priority 3: Priority of third operation p: Number of decimals Possible settings: 0, 1, 2, 3</p>
Output AQ	The output AQ is the result of the equation formed from the operand values and operators. AQ will be set to 32767 if a divide by 0 or overflow occurs, and -32768 if a negative overflow (underflow) occurs.



0BA1- 0BA5:

The mathematic instruction function block did not exist prior to 0BA6.

Parameters V1, V2, V3, and V4

The values V1, V2, V3, and V4 can be provided by the actual value of another already-programmed function:

- Analog comparator: Ax - Ay
- Analog threshold trigger: Ax
- Analog amplifier: Ax
- Analog multiplexer: AQ
- Analog ramp: AQ
- Mathematic instruction: AQ

- PI controller: AQ
- Up/Down counter: Cnt

For the **OBA7** and **OBA8** devices, you can additionally use the actual values of the following already-programmed functions:

- On-delay: Ta
- Off-delay: Ta
- On-/off-delay: Ta
- Retentive on-delay: Ta
- Wiping relay(pulse output): Ta
- Edge triggered wiping relay: Ta
- Asynchronous pulse generator: Ta
- Stairway light switch: Ta
- Multiple function switch: Ta
- Stopwatch: AQ
- Analog filter: AQ
- Average value: AQ
- Max/Min: AQ
- Threshold trigger: Fre

You select the required function by the block number.

Parameter p (number of decimals)

Parameter p applies to the display of V1, V2, V3, V4 and AQ in a message text.

Description of the function

The mathematic instruction function combines the four operands and three operators to form an equation. The operator can be any one of the four standard operators: +, -, *, or /. For each operator, you must set a unique priority of High ("H"), Medium ("M"), or Low ("L"). The high operation will be performed first, followed by the medium operation, and then by the low operation. You must have exactly one operation of each priority. The operand values can reference another previously-defined function to provide the value. The mathematic instruction function rounds the result to the nearest integer value.

The number of operand values is fixed at four and the number of operators is fixed at 3. If you need to use fewer operands, use constructions such as " + 0" or " * 1" to fill the remaining parameters.

You can also configure the behavior of the function when the Enable parameter "En"=0. The function block can either retain its last value or be set to 0.

Possible errors: Zero division and overflow

If the mathematic instruction function block execution results in zero division or overflow, it sets internal bits that indicate the type of error that occurred. You can program an mathematic instruction error detection function block in your circuit program to detect these errors, and to control the program behavior as needed. You program one mathematic instruction error detection (Page 337) function block to reference one specific mathematic instruction function block.

Examples

The following tables show some simple example mathematic instruction block parameters, and the resulting equations and output values:

V1	Operator1 (Priority 1)	V2	Operator2 (Priority 2)	V3	Operator3 (Priority 3)	V4
12	+ (M)	6	/ (H)	3	- (L)	1

Equation: $(12 + (6 / 3)) - 1$
Result: 13

V1	Operator1 (Priority 1)	V2	Operator2 (Priority 2)	V3	Operator3 (Priority 3)	V4
2	+ (L)	3	* (M)	1	+ (H)	4

Equation: $2 + (3 * (1 + 4))$
Result: 17

V1	Operator1 (Priority 1)	V2	Operator2 (Priority 2)	V3	Operator3 (Priority 3)	V4
100	- (H)	25	/ (L)	2	+ (M)	1

Equation: $(100 - 25) / (2 + 1)$
Result: 25

Special functions (Page 212)

5.3.3.9 Analog filter (0BA7 and 0BA8 only)



Short Description

The Analog filter function block is used to smooth the analog input signal.

Connetion	Description
Input Ax	<p>Input Ax is one of the following analog signals:</p> <ul style="list-style-type: none"> • AI1 to AI8 (*) • AM1 to AM16 (if 0BA7), or AM1 to AM64 (if 0BA8) • NAI1 to NAI32 • AQ1 and AQ2 (if 0BA7), or AQ1 to AQ8 (if 0BA8) • NAQ1 to NAQ16 • The block number of a function with analog output
Parameter	<p>Sn (Number of samples): determines how many analog values are sampled within the program cycles that are determined by the set number of samples. LOGO! samples an analog value within every program cycle. The number of program cycles is equal to the set number of samples.</p> <p>Possible settings: 8, 16, 32, 64, 128, 256</p>
Output AQ	<p>AQ outputs an average value of the analog input Ax over the current number of samples, and it is set or reset depending on the analog input and the number of samples.</p>
<p>* AI1 to AI8: 0 to 10 V corresponds with 0 to 1000 (internal value).</p>	

Parameter

You can set the number of samples to the following values:

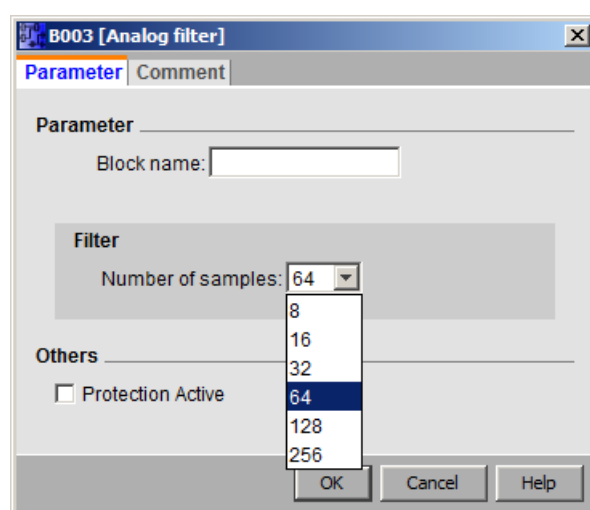

After you set the parameter, the analog filter calculates the average value of the samples and assigns this value to AQ.

Timing diagram

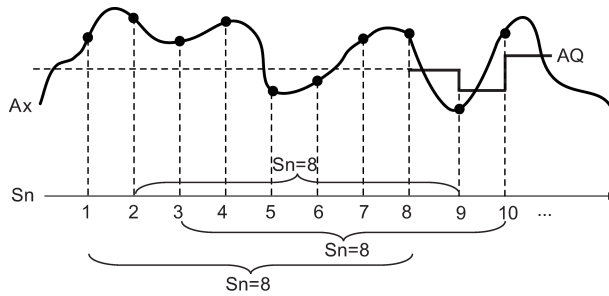

Description of function

The function outputs the average value after sampling the analog input signal according to the set number of samples. This SFB can reduce the error of analog input signal.

Note

There are a maximum of eight analog filter function blocks available for use in the circuit program in LOGO!Soft Comfort V7.0 or V8.0.

Special Functions Overview (Page 212)

5.3.3.10 Max/Min (0BA7 and 0BA8 only)

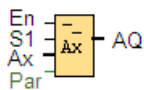

Short description

The Max/Min function block records the maximum or minimum value.

Connection	Description
Input En	The function of input En (Enable) depends on the settings of parameter Mode and the selection of check box "when En = 0, reset Max/Min".
Input S1	This input is enabled when you set Mode =2: A positive transition (0 to 1) at input S1 sets the output AQ to the maximum value. A negative transition (1 to 0) at input S1 sets the output AQ to the minimum value.

Input Ax	<p>Input Ax is one of the following analog signals:</p> <ul style="list-style-type: none"> • AI1 to AI8 (*) • AM1 to AM16 (if 0BA7), or AM1 to AM64 (if 0BA8) • NAI1 to NAI32 • AQ1 to AQ2 (if 0BA7), or AQ1 to AQ8 (if 0BA8) • NAQ1 to NAQ16 • Block number of a function with analog output
Parameter	<p>Mode</p> <p>Possible settings: 0, 1, 2, 3</p> <p>Mode = 0: AQ = Min</p> <p>Mode = 1: AQ = Max</p> <p>Mode = 2 and S1= 0 (low): AQ = Min</p> <p>Mode = 2 and S1= 1 (high): AQ = Max</p> <p>Mode = 3 or a block value is referenced: AQ = Ax</p>
Output AQ	<p>AQ outputs a minimum, maximum, or actual value depending on the inputs, or is reset to 0 if configured to do so when function is disabled</p>
<p>* AI1 to AI8: 0 to 10 V corresponds with 0 to 1000 (internal value).</p>	

Parameter Mode

You can set the values for parameter **Mode** based on the actual values of another already-programmed function:

- Analog comparator: Ax - Ay
- Analog threshold trigger: Ax
- Analog amplifier: Ax
- Analog multiplexer: AQ
- Analog ramp: AQ
- Mathematic instruction: AQ
- Up/Down counter: Cnt
- Threshold trigger: Fre
- Max/Min: Ax
- PI controller: AQ
- Analog filter (0BA7 only): AQ
- Average value (0BA7 only): AQ
- On-delay: Ta
- Off-delay: Ta
- On-/Off-delay: Ta
- Retentative on-delay: Ta
- Wiping relay (pulse output): Ta

- Edge triggered wiping relay: Ta
- Asynchronous pulse generator: Ta
- Stairway lighting switch: Ta
- Multiple functions switch: Ta
- Stopwatch (0BA7 only): AQ

You can select the required function by the block number.

Timing diagram

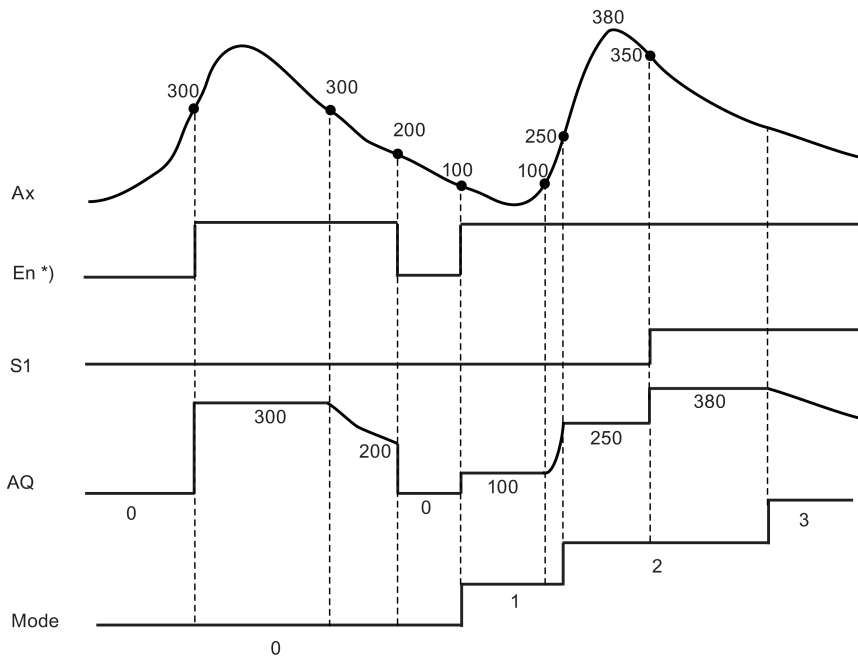

*) If you select the check box "when En = 0, reset Max/Min"

Description of the function

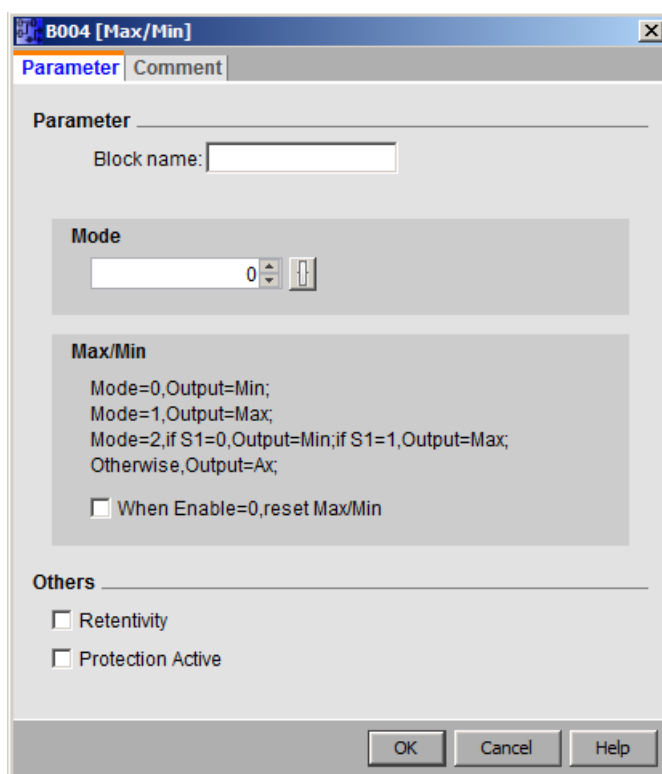

If you select the check box "when Enable = 0, reset Max/Min":

- Enable = 0: The function sets the AQ value to 0.
- Enable = 1: The function outputs a value at AQ, depending on the settings of Mode and S1.

If you do not select the check box "when Enable = 0, reset Max/Min":

- Enable = 0: The function holds the value of AQ at the current value.
- Enable = 1: The function outputs a value at AQ, depending on the settings of Mode and S1.

Mode = 0: The function sets AQ to the minimum value

Mode = 1: The function sets AQ to the maximum value

Mode = 2 and S1 = 0: The function sets AQ to the minimum value

Mode = 2 and S1 = 1: The function sets AQ to the maximum value

Mode = 3 or a block value is referenced: The function outputs actual analog input value.

Special functions (Page 212)

See also

- Analog comparator (Page 262)
- Analog threshold trigger (Page 255)
- Analog amplifier (Page 268)
- Analog multiplexer (Page 269)
- Analog ramp (Page 304)
- Mathematic instruction (Page 276)
- Up/Down counter (Page 247)
- PI controller (Page 300)
- Analog filter (0BA7 and 0BA8 only) (Page 279)
- Average value (0BA7 and 0BA8 only) (Page 285)
- On-delay (Page 217)
- Off-delay (Page 218)
- On-/Off-delay (Page 220)
- Retentive on-delay (Page 222)
- Wiping relay (pulse output) (Page 224)
- Edge triggered wiping relay (Page 225)
- Asynchronous pulse generator (Page 228)
- Stairway lighting switch (Page 232)
- Multiple function switch (Page 234)
- Stopwatch (0BA7 and 0BA8 only) (Page 245)

5.3.3.11 Average value (0BA7 and 0BA8 only)

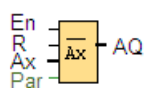

Short description

The average value function samples the analog input signal during configured time period and outputs the average value at **AQ**.

Connetion	Description
Input En	A positive edge (0 to 1 transition) at input En (Enable) sets the output AQ to the average value of input Ax after the configured time. A negative edge (1 to 0 transition) holds the output at its last calculated value.
Input R	A positive edge (0 to 1 transition) at input R (Reset) resets the output AQ to 0.
Input Ax	Input Ax is one of the following analog signals: <ul style="list-style-type: none"> • AI1 to AI8 (*) • AM1 to AM16 (if 0BA7), or AM1 to AM64 (if 0BA8) • NAI1 to NAI32 • AQ1 and AQ2 (if 0BA7), or AQ1 to AQ8 (if 0BA8) • NAQ1 to NAQ16 • The block number of a function with analog output
Parameter	St (Sampling time): You can set it to Seconds, Days, Hours or Minutes. Range of values: If St = Seconds: 1 to 59 If St = Days: 1 to 365 If St = Hours: 1 to 23 If St = Minutes: 1 to 59 Sn (Number of samples): Range of values: If St = Seconds: 1 to St*100 If St = Days: 1 to 32767 If St = Hours: 1 to 32767 If St = Minutes and St ≤ 5 minutes: 1 to St*6000 If St = Minutes and St ≥ 6 minutes: 1 to 32767
Output AQ	AQ outputs the average value over the specified time of sampling.
* AI1 to AI8: 0 to 10 V corresponds with 0 to 1000 (internal value).	

Parameter St and Sn

Parameter **St** represents the sampling time and parameter **Sn** represents the number of samples.

Timing diagram

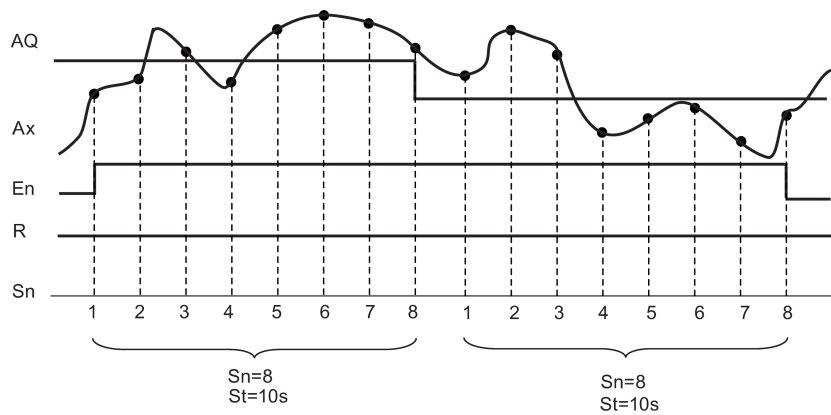

Description of the function

When $En = 1$, the average value function calculates the average value of the samples during the configured time interval. At the end of the sampling time, this function sets output **AQ** to this calculated average value.

When $En = 0$, the calculation stops, and **AQ** retains the last calculated value. When $R = 0$, **AQ** is reset to 0.

Special functions (Page 212)

5.3.4 Analog value processing

5.3.4.1 Basics

Analog and digital

An analog signal is a physical quantity, which, within a given range, can adopt any value - any continuous intermediate value. The opposite of analog is *digital*. A digital signal knows just two states: 0 and 1 or "off" and "on".

From electrical signal to analog value

Basic order of events

Several steps are required for LOGO! to process physical quantities:

1. LOGO! can read in electric voltages from 0 V to 10 V or electric currents from 0 mA to 20 mA to one analog input.
The physical quantities (for example, temperature, pressure, speed etc.) must therefore be converted into one electric quantity. This conversion is performed by an external sensor.
2. LOGO! reads in the electric quantity and, with further processing, converts it into a standardized value within the range 0 to 1000. This value is then used in the circuit program as the input of an analog special function.
3. In order to adapt the standardized value to the application, LOGO! uses an analog special function, while taking into consideration the gain and offset, to calculate the analog value. The analog value is then evaluated by the special function (for example, analog amplifier). If an analog special function has an analog output, then the analog value is used as the output of the special function.
4. With the LOGO! you can also convert analog values back into an electric voltage. In doing so, the voltage can adopt values between 0 V and 10 V.
5. Using this voltage, LOGO! can control an external actuator, which converts the voltage and also the analog value back into a physical quantity.

The following diagram illustrates this order of events.

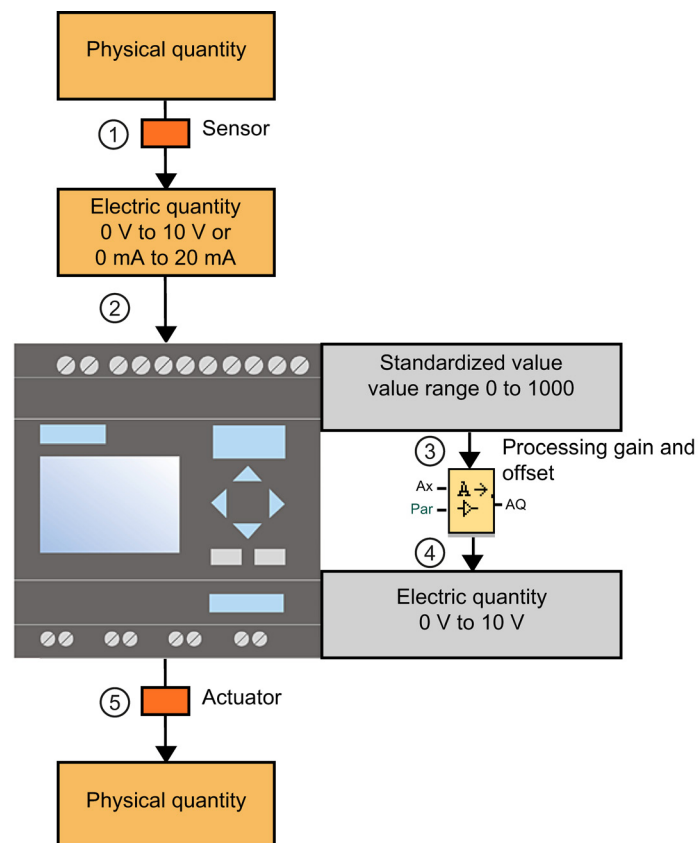

Gain

The standardized value is multiplied with a parameter. Using this parameter you can boost the electric quantity; hence, this parameter is called the "gain".

Zero point offset

You can add or subtract a parameter to or from the boosted standardized value.

Using this parameter you can move the zero point of the electric quantity; hence, this parameter is called the "zero point offset".

Gain and offset

The analog value is therefore calculated as follows:

$$\text{Analog value} = (\text{standardized value} \times \text{gain}) + \text{offset}$$

The following diagram illustrates this formula and the significance of gain and offset:

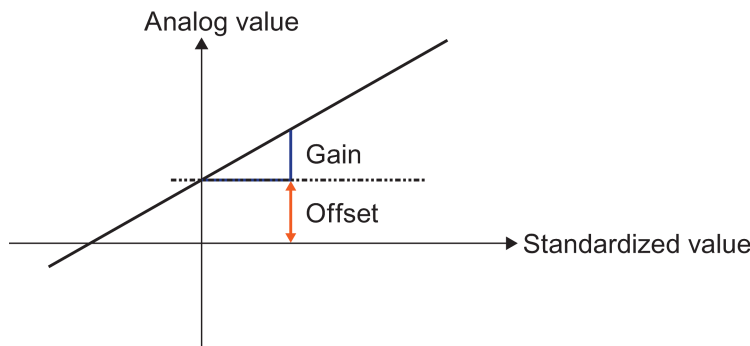

The straight line in the graphic describes which standardized value is being converted into which analog value. Gain corresponds to the slope of the straight line and offset to the movement of the zero point of the straight line on the y-axis.

Analog output

If you connect a special function (that has an analog output) to a **real** analog output, then note that the analog output can only process values from 0 to 1000.

Possible settings with LOGO!Soft Comfort (Page 289)

Possible settings with LOGO! (Page 290)

Example: Heating Control (Page 291)



0BA0 to 0BA4 (Page 292)

5.3.4.2 Possible settings with LOGO!Soft Comfort

Sensor

Set your sensor type. (0 V to 10 V; 0 mA to 20 mA; 4 mA to 20 mA; PT100/PT1000; no sensor)

With sensor type 4 mA to 20 mA the value range for the standardized value is 200 and 1000.

Measurement range

Stipulate the measurement range. The measurement range is the value range shown for the analog value.

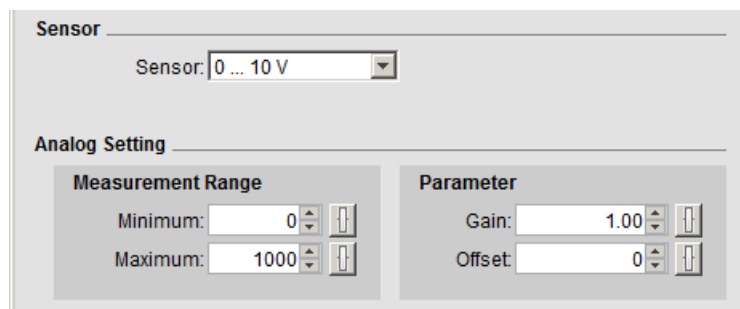

The screenshot shows a software interface for configuring a sensor. At the top, under the heading "Sensor", there is a dropdown menu labeled "Sensor:" with the value "0 ... 10 V" selected. Below this, under the heading "Analog Setting", there are two columns of settings. The left column, titled "Measurement Range", contains two input fields: "Minimum:" with the value "0" and "Maximum:" with the value "1000". The right column, titled "Parameter", contains two input fields: "Gain:" with the value "1.00" and "Offset:" with the value "0". Each input field has small up/down arrows and a vertical bar icon to its right, indicating they are adjustable.

LOGO!Soft Comfort then automatically calculates the gain and offset from this.

Gain and offset

If you want to set the gain, you can enter values between -10.00 and 10.00. The value 0 makes no sense, as, irrespective of the applied analog value, you will always obtain the value 0 as a result.

If you wish to set the offset, enter values between -10000 and 10000.

Rounding error

LOGO!Soft Comfort calculates the gain and zero point offset with utmost precision, while LOGO! calculates internally using whole numerical values; therefore, not all parameter combinations are possible on LOGO!. In this case, prior to transferring to LOGO!, LOGO!Soft Comfort detects a rounding error and proposes a possible replacement value range.

Simulation in LOGO!Soft Comfort

With simulation in LOGO!Soft Comfort you can read the following values:

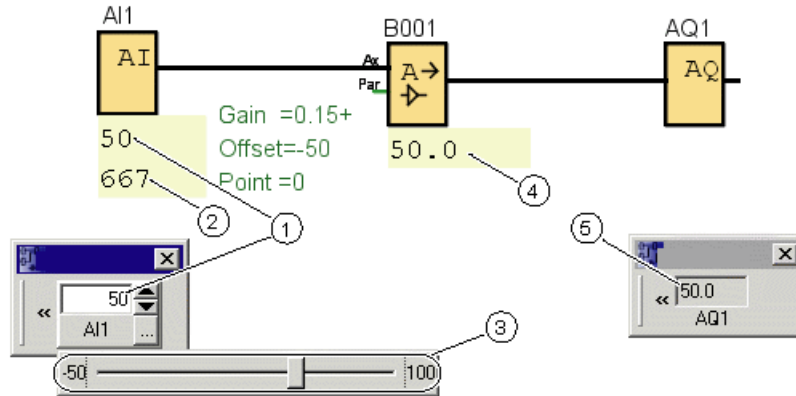

- ① Physical value; the ranges are stipulated by the measuring range (3)
- ② Standardized value
- ③ Measurement range
- ④ Analog value (after processing gain and offset)
- ⑤ Analog value on the analog output

5.3.4.3 Possible settings with LOGO!

If you directly program your circuit program on the LOGO!, then you can only enter the gain and offset parameters. You can calculate the gain and offset as follows:

External value range $\min_{\text{Sensor}} - \max_{\text{Sensor}}$:

Range of a physical quantity that the sensor can measure.

Standardized value range $\min_{\text{norm}} - \max_{\text{norm}}$:

Value range of the standardized values.

With sensors that provide 0 to 10 V or 0 to 20 mA, the standardized value range is 0 – 1000.

With sensors that provide 4 to 20 mA, the standardized range is 200 – 1000.

So for gain and offset it follows:

$$\text{Gain} = (\max_{\text{Sensor}} - \min_{\text{Sensor}}) / (\max_{\text{norm}} - \min_{\text{norm}})$$

$$\text{Offset} = [(\min_{\text{Sensor}} \times \max_{\text{norm}}) - (\max_{\text{Sensor}} \times \min_{\text{norm}})] / (\max_{\text{norm}} - \min_{\text{norm}})$$

If you have calculated either the gain or the offset in accordance with the formulas above, you can then calculate the respective other value in accordance with the following formula:

$$\text{Gain} = (\min_{\text{Sensor}} - \text{Offset}) / \min_{\text{norm}}$$

$$\text{Offset} = (\min_{\text{Sensor}} - (\text{Gain} \times \min_{\text{norm}}))$$

5.3.4.4 Example

Prerequisites

Sensor: temperature sensor, measuring range: -50 °C to 100 °C

Temperature to be measured: 25 °C

Order of events with LOGO!Soft Comfort

1. The sensor converts the temperature from 25 °C to a voltage value of 5.0 V.
2. LOGO!Soft Comfort converts the 5.0 V to the standardized value 500.
3. Using the sensor and measurement range data, LOGO!Soft Comfort calculates and ascertains the value 0.15 for the gain and the value -50 for the offset.
According to the formula:
Analog value = (standardized value × gain) + offset
LOGO!Soft Comfort calculates as analog value:
Analog value = (500 × 0.15) - 50 = 25

Order of events with LOGO!

1. The sensor converts the temperature from 25 °C to a voltage value of 5.0 V.
2. LOGO! converts the 5.0 V to the standardized value 500.
3. From the sensor and measuring range data, you must establish the values for gain and offset.
According to the formulas:
 $\text{Gain} = (\text{max}_{\text{Sensor}} - \text{min}_{\text{Sensor}}) / (\text{max}_{\text{norm}} - \text{min}_{\text{norm}})$
and
 $\text{Offset} = \text{min}_{\text{Sensor}} - (\text{Gain} \times \text{min}_{\text{norm}})$
it follows that
 $\text{Gain} = (100 - (-50)) / (1000 - 0) = 0.15$
 $\text{Offset} = -50 - (0.15 \times 0) = -50$
4. According to the formula
Analog value = (standardized value × gain) + offset
LOGO! calculates as analog value:
Analog value = (500 × 0.15) - 50 = 25

Additional examples

Physical quantity	Electric quantity of sensor	Standardized value	Gain	Offset	Analog value
	0 V 5 V 10 V	0 500 1000	0.01	0	0 5 10
	4 mA 12 mA 20 mA	0 500 1000	10	0	0 5000 10000
	0 mA 10 mA 20 mA	0 500 1000	1	50	50 550 1050
1000 mbar 3700 mbar 5000 mbar	0 V 6.75 V 10 V	0 675 1000	4	1000	1000 3700 5000
-30 °C 0 °C 70 °C	0 mA 6 mA 20 mA	0 300 1000	0.1	-30	-30 0 70

5.3.4.5 OBA0 to OBA4



Restriction for device family OBA4

The Gain cannot be a negative value.

Calculation with the device families OBA0 to OBA3

With LOGO! devices from these device families, LOGO! adds or subtracts the parameter offset to or from the standardized value **before** multiplying the value with the parameter gain.

Therefore, the following formulas apply:

$$\text{Analog value} = (\text{standardized value} + \text{offset}) \times (\text{gain} \times 100)$$

$$\text{Gain (in percent)} = (\text{max}_{\text{Sensor}} - \text{min}_{\text{Sensor}}) / [(\text{max}_{\text{norm}} - \text{min}_{\text{norm}}) \times 100]$$

$$\text{Offset} = [(\text{min}_{\text{Sensor}} \times \text{max}_{\text{norm}}) - (\text{max}_{\text{Sensor}} \times \text{min}_{\text{norm}})] / (\text{max}_{\text{Sensor}} - \text{min}_{\text{Sensor}})$$

$$\text{Gain (in percent)} = \text{min}_{\text{Sensor}} / [(\text{min}_{\text{norm}} + \text{offset}) \times 100]$$

$$\text{Offset} = [\text{max}_{\text{Sensor}} / (\text{gain} \times 100)] - \text{max}_{\text{norm}}$$

Gain

This parameter is given in %.

The Gain (Page 286) cannot be a negative value.

Zero point offset

You can enter values between -999 and +999 for the zero point offset (Page 286).

5.3.5 Control and regulate

5.3.5.1 Control and regulate basics

In engineering, quantities can be both controlled and regulated.

Controlling manipulates a quantity without being able to compensate for outside influences. Regulating maintains a quantity at a specific value in order to compensate for outside influences.

In the following example, controlling means that the person can set the heat output at a fixed value. The heater cannot compensate for the drop in room temperature when a window is opened.

In the example below, regulating means that the person can increase the heat output if the room temperature drops below 20 °C. If the room temperature rises above 20 °C, the heat output is reduced.

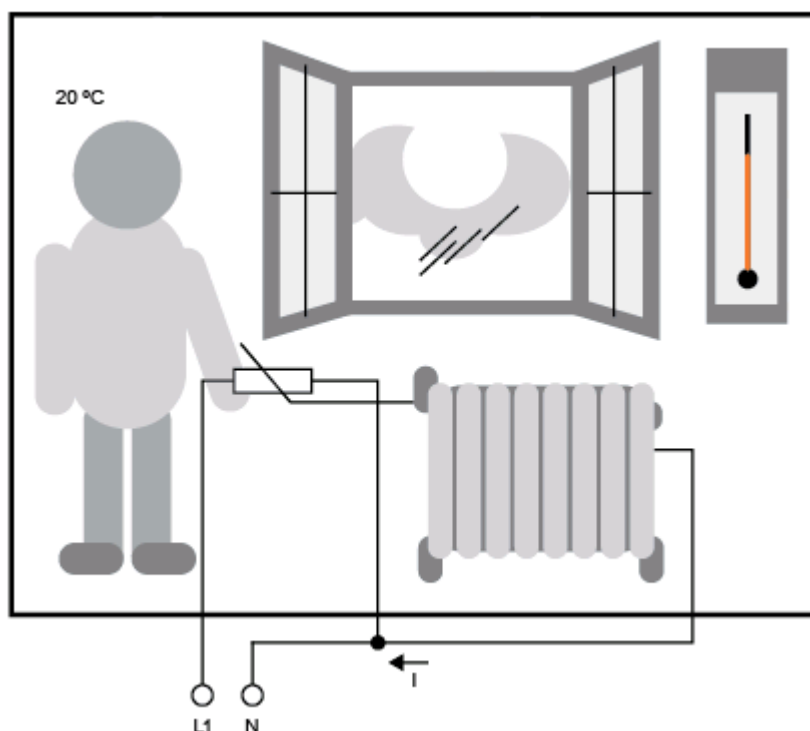

Basic concepts of regulating

In the example, the current for the electric heating is the **manipulated variable**. The changeable resistance is the **actuator**. The hand that operates the actuator is the **control**. The actual room temperature is the controlled variable or the **process value**. The desired room temperature is the **command variable** or the setpoint value. The electric heating is the **control process**. The thermometer is the **sensor**. The temperature loss from opening the window is the **disturbance variable**.

So this means that the person measures the process value (room temperature) with the sensor (thermometer), compares the process value (room temperature) with the command variable (desired room temperature) and uses the actuator (changeable resistance) to manually regulate the manipulated variable (heating current), in order to compensate for the disturbance variable (temperature drop from opening the window). The person is therefore the controller.

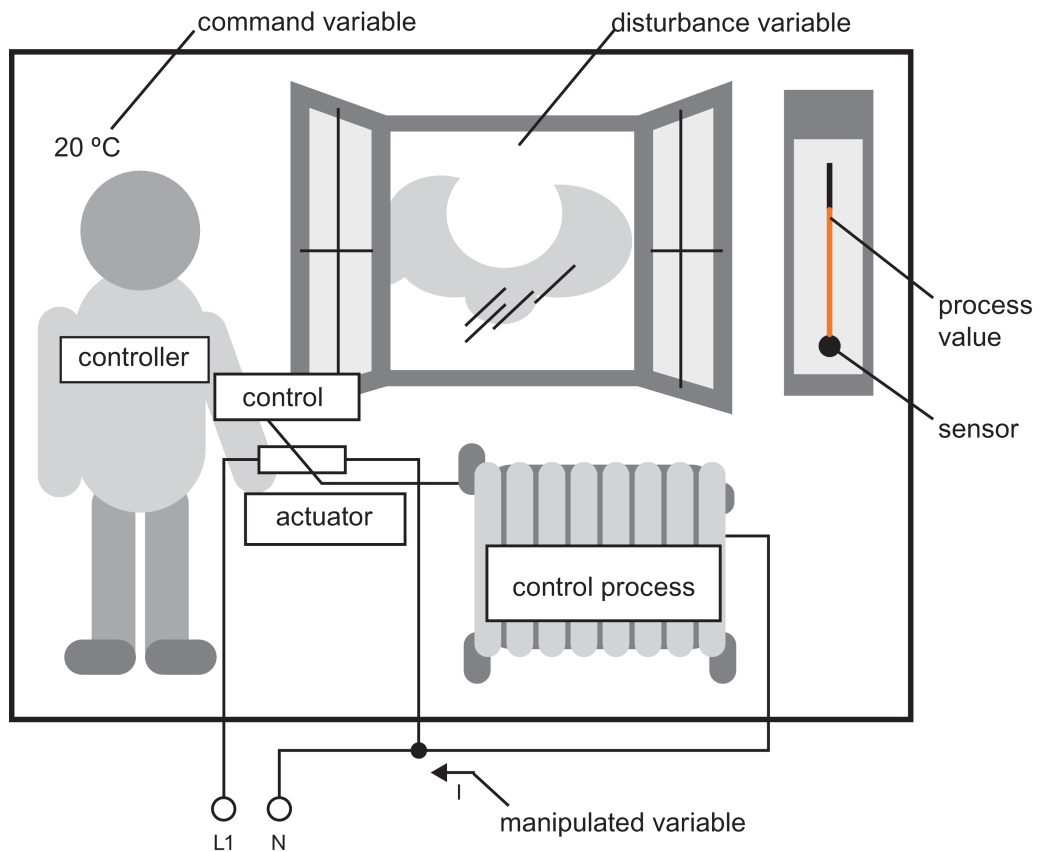

The **control device** consists of the actuator and the control.

The control and controller together form the **regulating device**.

The following picture gives an abstract portrayal of the situation described above.

The comparing element uses the sensor to compare the command variable with the process value. If the command variables and process value deviate from one another, this results in a positive or negative loop error that in turn changes the process value.

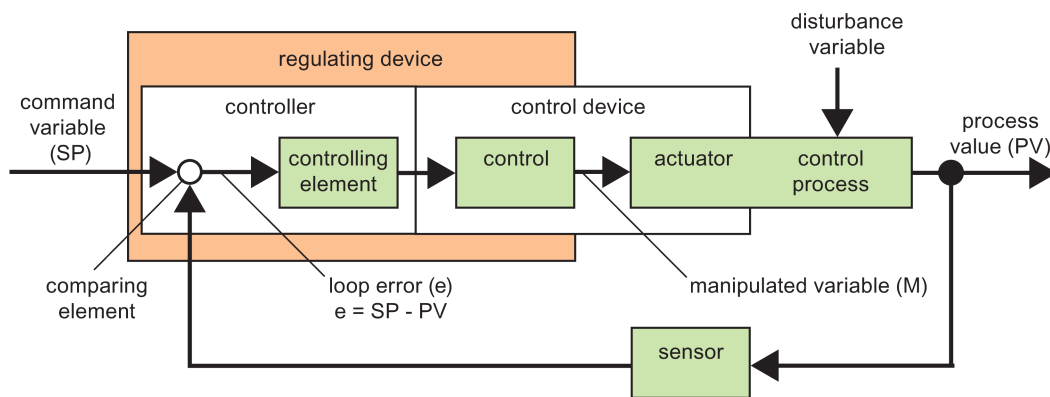

Control loop

The process value x influences the manipulated variable M by means of the regulating device. This creates a closed circuit that is also known as a **control loop**.

If, in the example above, the window is opened, the temperature in the room drops. The person must increase the heat output of the heater. If the heat output increases too much, it gets too hot. The person must then reduce the heat output.

If the heat output increases or reduces too quickly, then the control loop starts to oscillate. The room temperature fluctuates. It is either too hot or too cold. To prevent this, the person must carefully and slowly reduce or increase the heat output.

Loop error

The loop error is the difference between the command variable and the process value. In other words: the deviation of a process value from a set value.

$$e = SP - PV$$

The loop error e brings about a change to the manipulated variable M .

The example above illustrates this very well: if, with a desired temperature of 20 °C (= command value w), the room temperature is 22 °C (= process value PV), this results in the loop error:

$$e = SP - PV = 20 \text{ °C} - 22 \text{ °C} = -2 \text{ °C}$$

In this case, the negative sign indicates a reversing action: the heat output reduces.

In a control loopstate of equilibrium, the loop error is zero or very small. If the command variable changes or there is a disturbance, a loop error arises. The manipulated variable M corrects the loop error.

Controller basics (Page 296)

Description of the individual parameters (Page 299)

PI controller (Page 300)

Heating control (Page 184)

Analog ramp (Page 304)

5.3.5.2 Controller basics

A controller can be simply portrayed as follows:

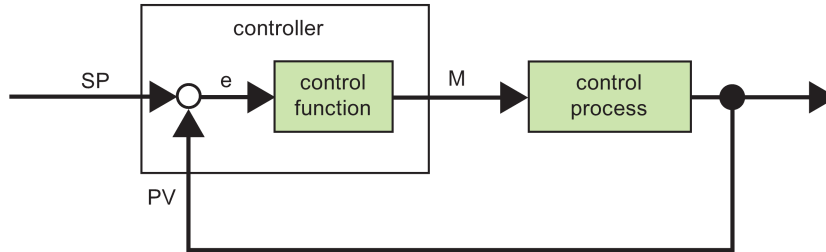

The comparing element and the controller function describe the conduct of the controller. The following describes the most important types of controller. A controller step response tells us a lot about its conduct. The step response describes how a controller reacts to the erratic change in the process value.

The three basic types of controllers are as follows:

- Proportional-action controller (P controller)
- Integral-action controller (I controller)
- Differential-action controller (D controller – not described here)

Controllers can combine the three types. For example, a PI controller is a proportional/integral controller.

P Controller

A proportional-action controller (P controller) changes the manipulated variable M proportional to the loop error. The P controller works immediately. By it cannot drive the loop error to zero.

$$M_{Pn} = k_P \times e_n$$

M_{Pn} : Manipulated variable of the P controller at the time n

k_P : Gain of the P controller

e_n : Loop error at the time n

The following picture shows a jump in process value and step response of the controller:

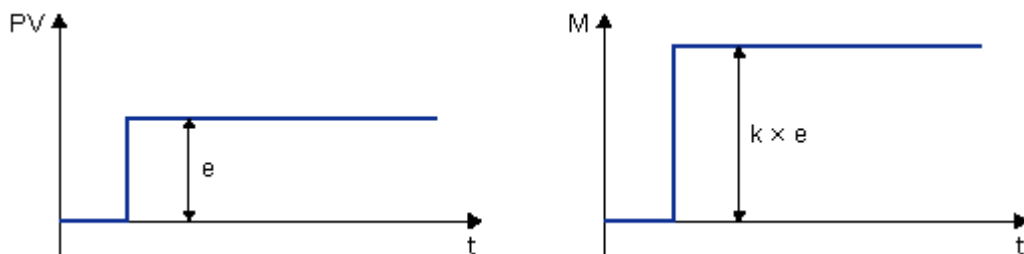

Summary

The P controller has the following characteristics:

- It cannot correct faults with the control process > lasting loop error.
- It reacts immediately to a change in the process value.
- It is stable.

I Controller

An integral-action controller (I controller) changes the manipulated variable M proportional to the loop error and to the time. The I controller works by delayed action. It completely remedies a loop error.

In order to calculate the value of the manipulated variable at a period of time **n**, the time up until this period of time must be divided into small time slices. The loop errors at the end of each time slice must be added up (integrated) and they are then entered in the calculation.

$$M_{In} = k_I \times (T_S / T_I) \times (e_n + e_{n-1} + e_{n-2} + e_{n-3} + \dots + e_0) = k_I \times (T_S / T_I) \times e_n + M_{In-1}$$

M_{In} : Manipulated variable of the I controller at the time n

M_{In-1} : Manipulated variable of the I controller at the time n-1; also called integral sum

k_I : Gain of the I controller

T_S : Sampling time, duration of a time slice

T_I : Integral time: by means of this time, the influence of the integral part is controlled on the manipulated variable, also known as integral-action time

e_n : Loop error at the time n

e_{n-1} : Loop error at the time n-1; etc.

e_0 : Loop error at the beginning of the calculations

The following picture shows a jump in process value and step response of the controller:

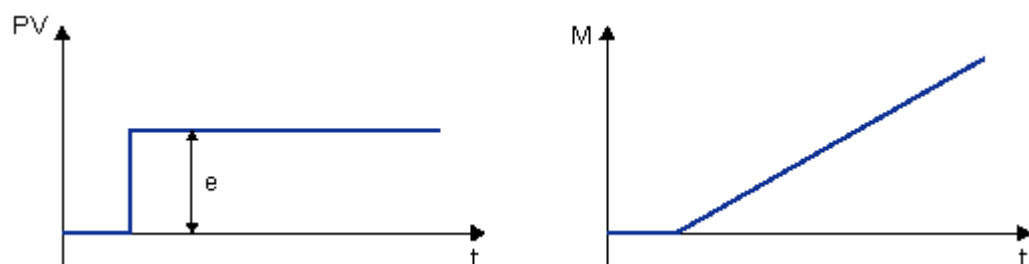

Summary

The I controller has the following characteristics:

- It sets the process value exactly to the command variable.
- By so doing, it tends to oscillate and is unstable.
- It requires more time to carry out the control action than the P controller .

PI controller

A PI controller reduces the loop error immediately and will eventually drive the loop error to zero.

$$M_n = M_{Pn} + M_{In} = k_P \times e_n + k_I \times (T_S / T_I) \times e_n + M_{In-1}$$

M_n : Manipulated variable at the time n

M_{Pn} : Proportional part of the manipulated variable

M_{In} : Integral part of the manipulated variable

M_{In-1} : Manipulated variable of the I controller at the time n-1; also called integral sum

k_P : Gain of the P controller

k_I : Gain of the I controller

T_S : Sampling time, duration of a time slice

T_I : Integral time; by means of this time the influence of the integral part is controlled on the manipulated variable, also known as the integral-action time

e_n : Loop error at the time n

The following picture shows a jump in process value and step response of the controller:

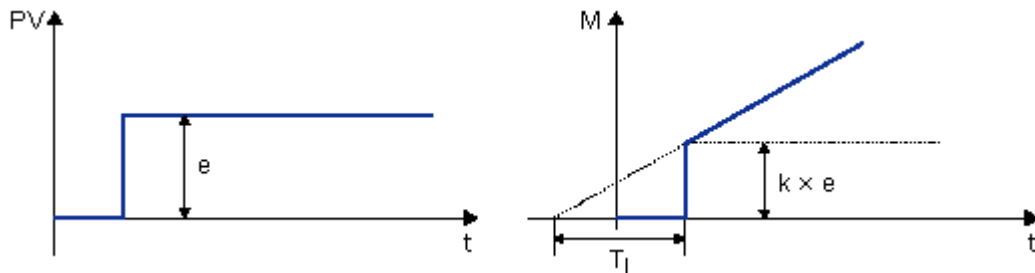

Summary

The PI controller has the following characteristics:

- The P controller components quickly intercept an occurring loop error.
- The I controller components can then remedy the remaining loop error.
- The controller components supplement each other so that the PI controller works quickly and precisely.

5.3.5.3 Description of the individual parameters

Controller parameters	Portrayed in LOGO!	Possible value range in the LOGO!
Mn Manipulated variable at the time n	Output of the PI controller block	0 to 1000
kP Gain of the P part kI Gain of the I part	In the LOGO!, the parameter KC applies as an increase for the I part and the P part of the controller equally Should you enter KC=0, then the P part of the controller switches off. In this special case, k is automatically set to 1 for the I part. If KC = 0: kP = 0 and kI = 1 If KC ≠ 0: kP = kI = KC	0.00 to 99.99
T _s Sampling time, duration of a time slice	Fixed	500 ms
T _I Integral time	Parameter T _I : if you set this parameter to 99.59 min, then you switch off the I part of the controller.	00:01 min to 99.59 min
e _n Loop error at the time n; generally applies: E = SP - PV	Refer to SP and PV	"
SP	The parameter SP is the set-value assignment w. For this parameter you can use the analog output of a different special function.	-10000 to +20000
PV	PV is the process value x and is calculated as follows: PV = analog value on input * gain) + offset. You can connect the input for example by means of an analog input with a PT100 sensor.	"
	The gain parameter has an effect on PV	0.0 to 10.0
	The offset parameter has an effect on PV	-10000 to +20000
	PV is restricted by the parameters Min. and Max.	In each case: 10000 to +20000
	The Dir parameter gives the action direction of the controller. Positive means: If set value > process value then the process value is increased; if set value < process value then the process value is reduced. Negative means: If set value > process value then the process value is reduced; if set value < process value then the process value is increased. Example, heat regulation: if the set value is greater than the process value (room is too cold), the manipulated variable increases the process value.	- or +

Refer to the PI controllers - description of special function for more details (for example, switching from manual to automatic mode, parameter sets, etc.).

5.3.5.4 PI controller

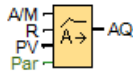

Short description

A PI controller is a proportional-action and integral-action controller. You can use both proportional action and integral action individually or combined.

Connection	Description
Input A/M	Set the mode of the controller: 1: automatic mode 0: manual mode
Input R	Use the input R to reset the output AQ. As long as this input is set, the input A/M is disabled. The output AQ is set to 0.
Input PV	Analog value: process value, influences the output
Parameter	Sensor: Type of sensor being used Min.: Minimum value for PV Value range: -10,000 to +20,000 Max.: Maximum value for PV Value range: -10,000 to +20,000 Gain Value range: -10.00 to +10.00 Offset Value range: -10,000 to +10,000 SP: Set-value assignment Value range: -10,000 to +20,000 Mq: Value from AQ with manual mode. Value range: 0 to 1,000 Parameter sets: application-related presets for KC, TI and Dir (see below) KC: Gain Value range: 00.00 to 99.99 TI: Integral time Value range 00:01 min to 99:59 min Dir: Action direction of the controller Possible settings: + or - p: Number of decimal places Possible settings: 0, 1, 2, 3
Output AQ	Analog output (manipulated variable) Value range for AQ: 0 to 1,000

Parameters SP and Mq

The actual value of another already-programmed function can provide the set-value SP and the value for Mq:

- Analog comparator: Ax - Ay
- Analog threshold trigger: Ax
- Analog amplifier: Ax
- Analog multiplexer: AQ
- Analog ramp: AQ
- Mathematic instruction: AQ
- Up/Down counter: Cnt

For the **OBA7** and **OBA8** devices, you can additionally use the actual values of the following already-programmed functions:

- On-delay: Ta
- Off-delay: Ta
- On-/off-delay: Ta
- Retentive on-delay: Ta
- Wiping relay(pulse output): Ta
- Edge triggered wiping relay: Ta
- Asynchronous pulse generator: Ta
- Stairway light switch: Ta
- Multiple function switch: Ta
- Stopwatch: AQ
- Analog filter: AQ
- Average value: AQ
- Max/Min: AQ
- Threshold trigger: Fre

You select the required function by the block number.

Parameter P (number of decimal places)

Parameter p only applies for displaying the values from PV, SP, Min. and Max. in a message text.

Timing diagram

The nature, manner and speed with which the AQ changes depends on the parameters KC and TI. Thus, the course of AQ in the diagram is merely an example. A control action is continuous; therefore the diagram portrays just an extract.

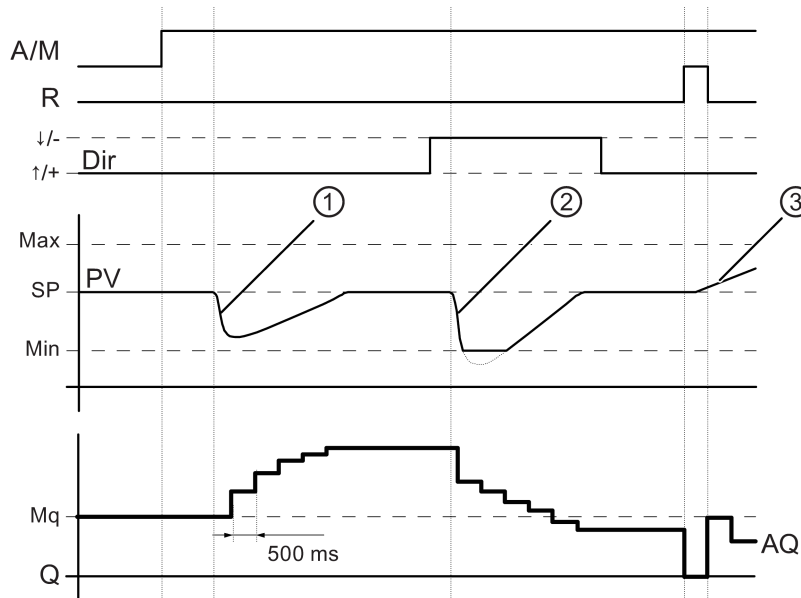

- ① A disturbance causes the PV to drop, as Dir is positioned upwards, AQ increases until PV corresponds again to SP.
 - ② A disturbance causes the PV to drop, as Dir is positioned upwards, AQ decreases until PV corresponds again to SP.
- Dir is coordinated to the basic conduct of a control loop. The direction (dir) cannot be changed during the term of the function. The change in Dir here is shown for the purposes of clarification.
- ③ As the input R sets AQ to 0, PV changes. This is based on the fact that PV increases, which on account of Dir = upwards causes AQ to drop.

PI controller trend view in simulation or online test

When you view the circuit program in an online test or in a simulation (Page 35), LOGO!Soft Comfort displays a trend view of the PI controller showing input PV, output AQ and the parameter SP. The trend view shows the change in AQ and PV over time, in reference to the SP. The time sampling period is configurable, allowing you to see frequent samples over a short amount of time, or less-frequent samples over a longer period of time.

Description of function

If the input A/M is 0, then the special function issues output AQ with the value that you set with parameter Mq.

If the input A/M is 1, then automatic mode commences. As the adopted value Mq is an integral sum, the controller function begins the calculations in accordance with the formulas given in Control and regulate basics (Page 293). Use the updated value PV in the formulas:

Updated value $PV = (PV * gain) + offset$

If the updated value $PV = SP$, then the special function does not change the value of AQ.

Dir = upwards/+ (timing diagram numbers 1 and 3)

- If the updated value $PV > SP$, then the special function reduces the value of AQ.
- If the updated value $PV < SP$, then the special function increases the value of AQ.

Dir = downwards/- (timing diagram number 2)

- If the updated value $PV > SP$, then the special function increases the value of AQ.
- If the updated value $PV < SP$, then the special function reduces the value of AQ.

With a disturbance, AQ increases or decreases until the updated value PV again corresponds to SP. The speed with which AQ changes depends on the parameters KC and TI.

If the input PV exceeds the parameter Max., then the updated value PV is set to the value of Max. If the PV falls short of the parameter Min., then the updated value PV is set to the value of Min.

If the input R is 1, then the AQ output is reset. As long as R is set, the input A/M is disabled.

Sampling time

The sampling time fixes at 500 ms.

Parameter sets

In order to simplify the use of the PI controller, the parameters for KC, TI and Dir are already given as sets for the following applications:

Parameter set	Application example	Parameter KC	Parameter TI (s)	Parameter Dir
Temperature fast	Temperature, cooling control of small spaces; small volumes	0.5	30	+
Temperature slow	Heating, ventilation, temperature, cooling control of large spaces; large volumes	1.0	120	+
Pressure 1	Quick pressure change, compressor control	3.0	5	+
Pressure 2	Slow pressure change, differential pressure control (flow controller)	1.2	12	+
Full level 1	Vat and/or reservoir filling without drain	1.0	99:59	+
Full level 2	Vat and/or reservoir filling with drain	0.7	20	+

Characteristics when configuring

Observe the control and regulate basics (Page 293).

Special functions (Page 212)

5.3.5.5 Analog ramp

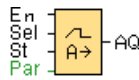

Short Description

The Analog Ramp instruction allows the output to be changed from the current level to the selected level at a specified rate.

Connection	Description
Input En	<p>A change in the status from 0 to 1 at input En (Enable) applies the start/stop level (Offset "B" + StSp) to the output for 100 ms and starts the ramp operation to the selected level.</p> <p>A change in the status from 1 to 0 immediately sets the current level to Offset "B", which makes output AQ equal to 0.</p>
Input Sel	<p>Sel = 0: The step 1 (level 1) is selected. Sel = 1: The step 2 (level 2) is selected.</p> <p>A change in status of Sel causes the current level to start changing to the selected level at the specified rate.</p>
Input St	<p>A change in the status from 0 to 1 at input St (Decelerated Stop) causes the current level to decrease at a constant rate until the start/stop level (Offset "B" + StSp) is reached. The start/stop level is maintained for 100 ms and then the current level is set to Offset "B", which makes output AQ equal to 0.</p>
Parameter	<p>L1 and L2: Levels to be reached; value range for each level: -10000 to 20000</p> <p>MaxL: Maximum value that must not be exceeded. Value range: -10000 to 20000</p> <p>StSp: Start/Stop offset: value that is added to Offset "B" to create the start/stop level. If the Start/Stop offset is 0, then the start/stop level is Offset "B". Value range: 0 to 20000</p> <p>Rate: Speed with which level 1, level 2 or offset is reached. Steps/seconds are issued. Value range: 1 to 10000</p> <p>Gain Value range: 0 to 10.00</p> <p>Offset Value range: -10000 to 10000</p> <p>p: Number of decimal places Possible settings: 0, 1, 2, 3</p>
Output AQ	<p>The output AQ is scaled using the formula: (Current Level - Offset "B") / Gain "A"</p> <p>Note: when AQ is displayed in parameter mode or message mode, it is displayed as an unscaled value (engineering units: current level).</p> <p>Value range for AQ: 0 to 32767</p>

Parameters Level1 and Level2

The level parameters Level 1 and Level 2 can be provided by the actual value of another already-programmed function:

- Analog comparator: Ax - Ay
- Analog threshold trigger: Ax
- Analog amplifier: Ax
- Analog multiplexer: AQ
- Mathematic instruction: AQ
- PI controller: AQ
- Up/Down counter: Cnt

For the **OBA7** and **OBA8** devices, you can additionally use the actual values of the following already-programmed functions:

- On-delay: Ta
- Off-delay: Ta
- On-/off-delay: Ta
- Retentive on-delay: Ta
- Wiping relay(pulse output): Ta
- Edge triggered wiping relay: Ta
- Asynchronous pulse generator: Ta
- Stairway light switch: Ta
- Multiple function switch: Ta
- Stopwatch: AQ
- Analog filter: AQ
- Average value: AQ
- Max/Min: AQ
- Threshold trigger: Fre

You select the required function by the block number.

Parameter p (number of decimal places)

Parameter p only applies for displaying the values of AQ, level 1, level 2, MaxL, StSp, and Rate in a message text.

Timing diagram for AQ

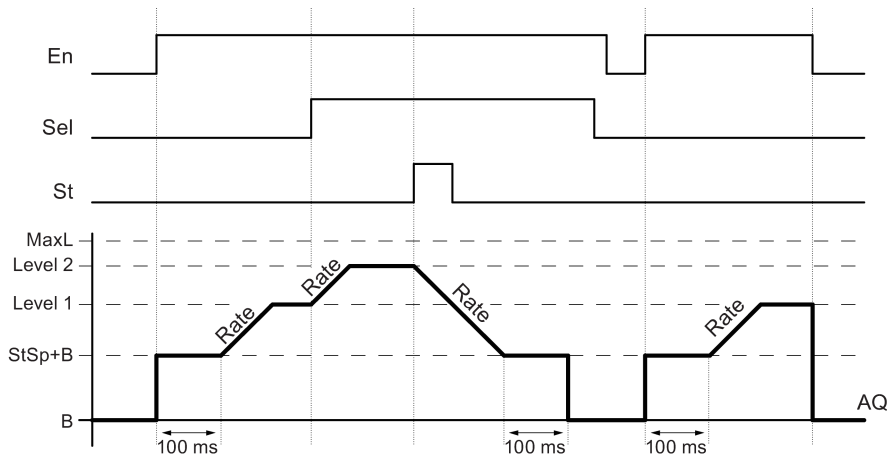

Description of function

If the input En is set, then the function sets the value StSp + Offset "B" for 100 ms.

Then, depending on the connection of Sel, the function runs from the level StSp + Offset "B" to either level 1 or level 2 at the acceleration set in Rate.

If the input St is set, the function runs to a level of StSp + B at the acceleration set in Rate. Then the function holds the level at StSp + Offset "B" for 100 ms. After 100 ms, the level is set to Offset "B". Output AQ. The scaled value (output AQ) is 0.

If the input St is set, the function can only be restarted once the inputs St and En have been reset.

If input Sel has been changed, depending on the connection of Sel, the function runs from the current target level to the new target level at the rate that is specified.

If the input En is reset, the function immediately sets the current level to Offset "B".

The current level is updated every 100 ms. Note the relationship between output AQ and the current level:

$$\text{Output AQ} = (\text{current level} - \text{Offset "B"}) / \text{Gain "A"}$$

Particular characteristics to be noted when configuring

For help on analog block parameters, refer to the Analog value processing (Page 286) section.

Special functions (Page 212)

5.3.6 Miscellaneous

5.3.6.1 Latching relay

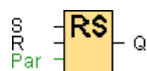

Short description

A signal at input S sets output Q. A signal at input R resets output Q.

Connection	Description
Input S	Set output Q with a signal at input S (Set).
Input R	Reset output Q with a signal at input R (Reset). Output Q is reset if S and R are both set (reset has priority over set).
Parameter	Retentivity set (on) = the status is retentive in memory.
Output Q	Q is set with a signal at input S and remains set until it is reset with signal at input R.

Timing diagram

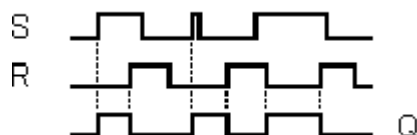

Description of the function

The latching relay represents a simple binary memory logic. The output value depends on the input states and the previous status at the output.

Logic table of the latching relay:

S	R	Q	Remark
0	0	x	Status unchanged
0	1	0	Reset
1	0	1	Set
1	1	0	Reset

When retentivity is enabled, the output signal corresponds with the signal status prior to the power failure.

Special functions (Page 212)

5.3.6.2 Pulse relay

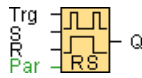

Short description

The output is set and reset with a short one-shot at the input.

Connection	Description
Input Trg	You switch output Q on or off with a signal at input Trg (Trigger) input.
Input S	A one-shot at input S (Set) sets the output to logical 1.
Input R	A one-shot at input R (Reset) resets the output to logical 0
Parameter	<p>Selection: RS (input R priority), or SR (input S priority)</p> <p>Retentivity set (on) = the status is retentive in memory.</p>
Output Q	Q is switched on with a signal at Trg and is reset again at the next Trg pulse, if both S and R = 0.

OBA0
OBA7

OBA0-OBA3:

The special function does not have an S input and priority preselection.

The following applies to output Q:

Q is switched on with a signal at Trg and is switched off again with the next signal at Trg or R.

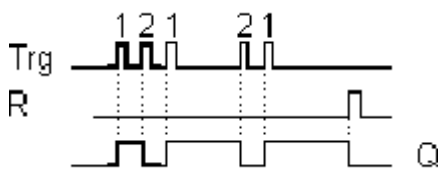

Timing diagram

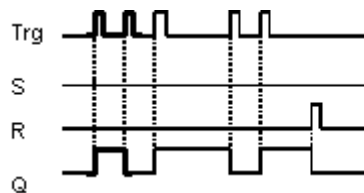

Description of the function

The status of output Q changes with each 0 to 1 transition at input Trg and if both S and R = 0, that is, the output is switched on or off.

Input Trg does not influence the SFB when S = 1 or R = 1.

A one-shot at input S sets the pulse relay, that is, the output is set to logical 1.

A one-shot at input R resets the pulse relay to its initial state, that is, the output is set to logical 0.

Either the input R takes priority over input S (the signal at input S has no effect as long as R = 1), or the input S takes priority over input R (the signal at input R has no effect as long as S = 1), depending on your configuration.



OBA0-OBA3:

The valid function is:

The status at output Q is toggled with each 0 to 1 transition at input Trg, that is, the output is switched on or off.

You reset the pulse relay to its initial state with a one-shot at input, that is, the output is reset to 0.

The pulse relay is reset and output Q = 0 after power on or by a reset signal.

Caution

If Trg = 0 and Par = RS, the "Pulse relay" SFB corresponds with the "Latching relay" SFB function.

Special functions (Page 212)

5.3.6.3 Message text (LOGO! 0BA8)

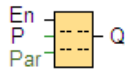

Short description

This function displays message texts and parameters of other blocks on the LOGO! onboard display or LOGO! TDE when LOGO! is in **RUN** mode.

Connection	Description
Input En	A 0 to 1 transition at En (Enable) triggers the output of the message text.
Input P	P is the priority of the message text. 0 is the lowest, 127 the highest priority. Ack: Acknowledgement of the message text
Parameter	<p>Text: Input of the message text</p> <p>Par: Parameter or actual value of another, already configured, which can be displayed numerically or as a bar graph (see "Visible parameters or actual values")</p> <p>Time: Shows the continuously updated time-of-day</p> <p>Date: Shows the continuously updated date</p> <p>EnTime: Display of the time of the 0 to 1 transition of the signal at input En</p> <p>EnDate: Display of the date of the 0 to 1 transition of the signal at input En</p> <p>I/O Status Names: Display of a digital input or output status name, for example "On" or "Off". LOGO! 0BA8 devices can display the status names of following elements:</p> <ul style="list-style-type: none"> • Digital inputs • Digital outputs • Flags • Cursor keys • LOGO! TDE function keys • Shift register bits • Function block outputs <p>Analog Input: Display of analog input value to be shown in message text and updated according to the analog time.</p> <p>Scale time: Display of the actual value of a referenced function block as a time value scaled based on the timebase configured for the message text function block. Possible time display formats are as shown below:</p> <ul style="list-style-type: none"> • hours : minutes : seconds . milliseconds • hours : minutes : seconds • hours : minutes • hours <p>(for example, "01: 20 : 15 .15")</p> <p>Symbol: Display of characters selected from the supported character sets</p>
Output Q	Q remains set as long as the message text is queued.

Settings

In addition to the function block inputs and the parameters of the message text, the following settings provide additional control over the display of message texts:







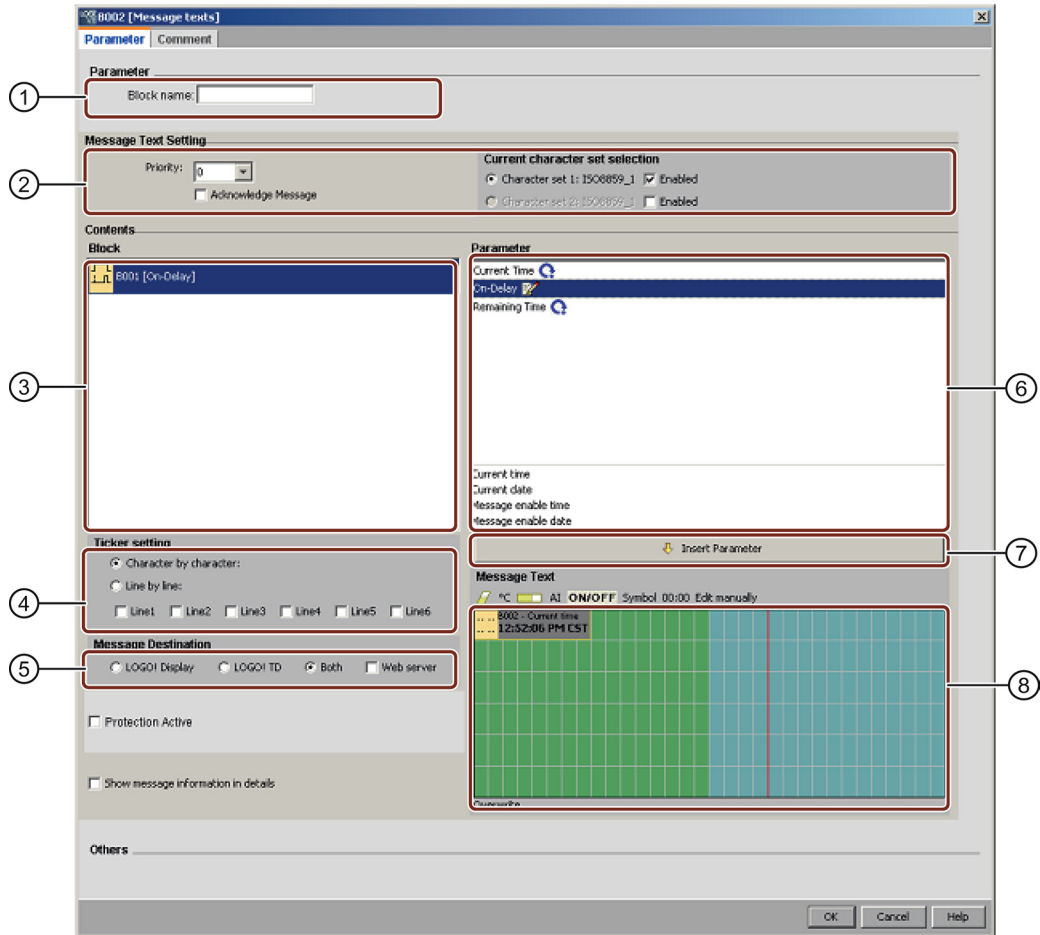

- **Character set selection:** You can choose to compose a message text from characters from the primary character set or the secondary character set. You set the two character sets from either the "Msg Config" menu on the LOGO! Base Module, or by using the LOGO!Soft Comfort File → Message Text Settings (Page 52) menu command.
- **Message destination:** You can choose to display the message text on the LOGO! onboard display, the LOGO! TDE, or both. If you select the Web server as a destination, you can display LOGO! message texts through the Web server.
- **Ticker setting:** The message text can tick or not tick, meaning it can scroll on and off the display. Two types of message ticking exist:
 - Character by character
 - Line by line

You can configure each individual line of a message text to tick or not to tick at all. The "character by character" or "line by line" setting applies to all lines that you configure to tick. Select the check box beside a line number to enable ticking for that line. The number of lines depends on your selection on the File → Message Text Settings (Page 52) dialog.

Particular characteristics to be noted when configuring



- ① **Block name area**
Here you can provide a name for the block
- ② **Settings area**
Here you can configure the following settings:
 - Priority of the message text
 - Acknowledge Message check box: if set requires a message to be acknowledged in order to be closed
 - Character set selection for the message text
- ③ **Block area**
Here is where you select blocks from all of the blocks in the circuit program. You can subsequently choose parameters from these blocks to display in the message text.
- ④ **Tick area**
Here you define the tick parameters for the message text:
 - Character by Character tick format
 - Line by Line tick format
 - Tick enabled checkbox for each display line

- ⑤ **Message destination area**
Here you choose whether the target destination for the message is the LOGO! onboard display, the LOGO! TDE, or both. If you select the Web server as a destination, you can display LOGO! message texts through the Web server.
- ⑥ **Block parameters area**
Here you can select the parameters to be displayed in the message text from the block that is selected in the Blocks area.
- ⑦ **Insert Parameter button**
This button is for inserting a selected block parameter into the message text.
- ⑧ **Message area**
Here you arrange the message text. The information that you enter in this area corresponds to what is to be displayed on the LOGO! onboard display or LOGO! TDE.
Above this area are additional buttons:
-  **Delete button:** for deleting entries from the message area
 -  **Special characters button:** for inserting special characters into the message area
 -  **Bar Graph button:** for placing a horizontal or vertical bar graph into the message area
 -  **AI button:** for placing an analog input value into the message area
 -  **ON/OFF ON/OFF button:** for specifying a digital value to be represented by one of two strings corresponding to the 0 state and 1 state, for example "OFF" and "ON".
 -  **Symbol button:** for opening the virtual keyboard panel. You can insert characters of current character set.
 -  **Scale time button:** for referencing an actual value and showing it in a specified time base format.
 -  **Edit manually button:** for using the static editor to add, move, or delete message text elements without changing the position of any other elements.

To arrange the message text

The LOGO! 0BA8 devices support six-line message text display. The message area shows a grid of six lines and character positions.

If you choose the LOGO! onboard display as the target destination for the message, the message text area is 32 characters wide for Western European character sets or 16 characters wide for Asian character sets. If you choose the LOGO! TDE as the target destination for the message, the message text area is 40 characters wide for Western European character sets or 20 characters wide for Asian character sets. Either way, the character width of each line is double that of the LOGO! onboard display or LOGO! TDE. If you choose both as the target destination, the message text area is still 32 characters wide for Western European character sets or 16 characters wide for Asian character sets. In this case, there is a red vertical line in the message text area indicating the boundary of the LOGO! TDE display. If you also select the Web server as a destination, the message text displays through the Web server in the same way as on the LOGO! onboard display.

Message lines that are longer than the width of the actual display can be set to "tick". In the message area, LOGO!Soft Comfort indicates the region corresponding to the visible area of the LOGO! onboard display or LOGO! TD in green, and the region that can only be shown by using the message ticking feature in blue.

To configure the content of a message text, follow these steps:

1. From the "Block" area, select the block whose parameters you want to output.
2. Drag and drop the parameters required from the "Parameter" area to the "Message Text" area. You can also use the "Insert Parameter" button to insert a parameter value.
3. In the "Message Text" area, you can add parameter data, time or date values from the block parameter area as required and enter text. To enter text, select the character set for the message text, and then type. You can also use the buttons above the message text area to add special characters, bar graphs, analog input values, and names for digital I/O states.

New special characters

There are five new special characters (▣ ▤ ▥ ▦ ▧) available for the message text display on LOGO! 0BA8 devices or LOGO! TDE. With these special characters, you can create large texts for message display.

Example:

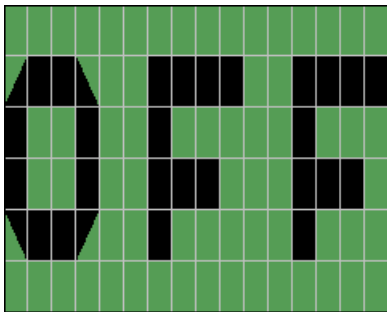

Simulation mode

Layout of message texts (Page 143)

Message online test

With the message online test function, you can view the same message texts as shown in the LOGO! Base Module.

You can start or stop messages online by clicking the  toggle button, and the messages are displayed as follows:

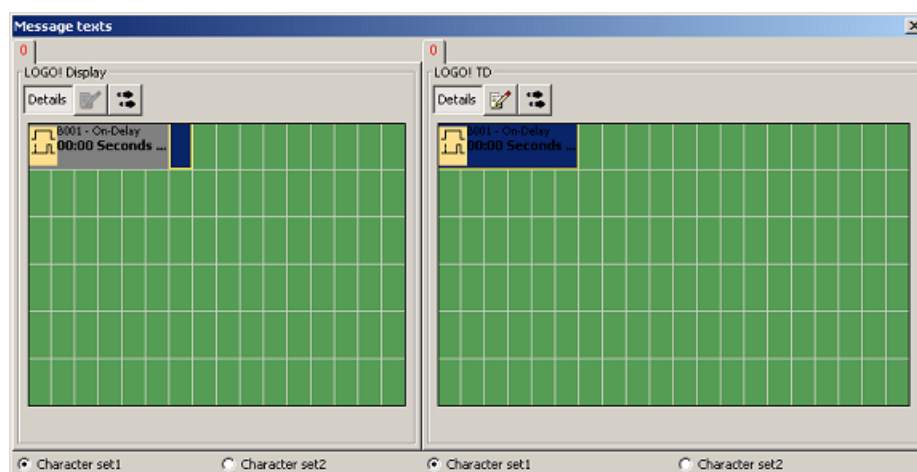

During a message online test, you cannot use LOGO!Soft Comfort to edit message text parameters, change the character set, acknowledge a message text, or shift a message text. You can, however, use the "Go to block" button.

Special Functions Overview (Page 212)

See also

Message text (LOGO! 0BA6 and LOGO! 0BA7) (Page 315)

5.3.6.4 Message text (LOGO! 0BA6 and LOGO! 0BA7)

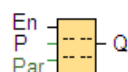

Short description

This function displays message texts and parameters of other blocks on the LOGO! onboard display or LOGO! TD when LOGO! is in **RUN** mode.

The LOGO! 0BA7 and 0BA6 devices support many new message text features that LOGO! 0BA5 devices and earlier did not support. Some of the new features are **only** for LOGO! 0BA7 devices. You can choose, however, whether to use the message text function block with the new features or LOGO! 0BA5 or earlier message text function blocks in your circuit program. This selection is on the File → Message Text Settings (Page 52) dialog, along with other global settings. You can also use the button "Enable new style message and setting" at the bottom of the message dialog to switch your message text function block to the one with the new features. You can not mix and match the message text function blocks with new features and LOGO! 0BA5 and earlier message text function blocks in your circuit program.

Connection	Description
Input En	A 0 to 1 transition at En (Enable) triggers the output of the message text.
Input P	P is the priority of the message text. 0 is the lowest, 127 the highest priority. Ack: Acknowledgement of the message text
Parameter	<p>Text: Input of the message text</p> <p>Par: Parameter or actual value of another, already configured, which can be displayed numerically or as a bar graph (see "Visible parameters or actual values")</p> <p>Time: Shows the continuously updated time-of-day</p> <p>Date: Shows the continuously updated date</p> <p>EnTime: Display of the time of the 0 to 1 transition of the signal at input En</p> <p>EnDate: Display of the date of the 0 to 1 transition of the signal at input En</p> <p>I/O Status Names: Display of a digital input or output status name, for example "On" or "Off". LOGO! OBA7 devices can display the status names of following elements:</p> <ul style="list-style-type: none"> • Digital inputs • Digital outputs • Flags • Cursor keys • LOGO! TD function keys • Shift register bits • Function block outputs <p>Analog Input: Display of analog input value to be shown in message text and updated according to the analog time.</p> <p>Scale time (OBA7 only): Display of the actual value of a referenced function block as a time value scaled based on the timebase configured for the message text function block. Possible time display formats are as shown below:</p> <ul style="list-style-type: none"> • hours : minutes : seconds . milliseconds • hours : minutes : seconds • hours : minutes • hours <p>(for example, "01: 20 : 15 .15")</p> <p>Symbol (OBA7 only): Display of characters selected from the supported character sets</p>
Output Q	Q remains set as long as the message text is queued.

Settings

In addition to the function block inputs and the parameters of the message text, the following settings provide additional control over the display of message texts:

- **Character set selection:** You can choose to compose a message text from characters from the primary character set or the secondary character set. You set the two character sets from either the "Msg Config" menu on the LOGO! Base Module, or by using the LOGO!Soft Comfort File → Message Text Settings (Page 52) menu command.
- **Message destination:** You can choose to display the message text on the LOGO! onboard display, the LOGO! TD, or both.
- **Tick settings:** The message text can tick or not tick, meaning it can scroll on and off the display. The tick capabilities and your choices are described in more detail below.

Description of the function

With a 0 to 1 transition of the signal at input En, and with LOGO! in run mode, the LOGO! onboard display and/or LOGO! TD displays your configured message text.

When the "Acknowledgement message" checkbox is not selected, the message text is hidden with a 1 to 0 signal transition at input En.

When the "Acknowledgement message" checkbox is selected, then after input En is reset to 0, the message text is displayed until acknowledged by pressing the OK button. The message text cannot be acknowledged as long as input En is high.

If several message text functions were triggered with En=1, the message with the highest priority (0 = lowest, 127 = highest) is displayed. This also implies that a new message text is only displayed if its priority is higher than that of previously enabled message texts.

If the circuit program uses flag M27 (Page 195), then whenever M27=0 (low) LOGO! only displays message texts that are in the primary character set (Character Set 1). If M27=1 (high), then LOGO! only displays message texts that are in the secondary character set (Character Set 2).







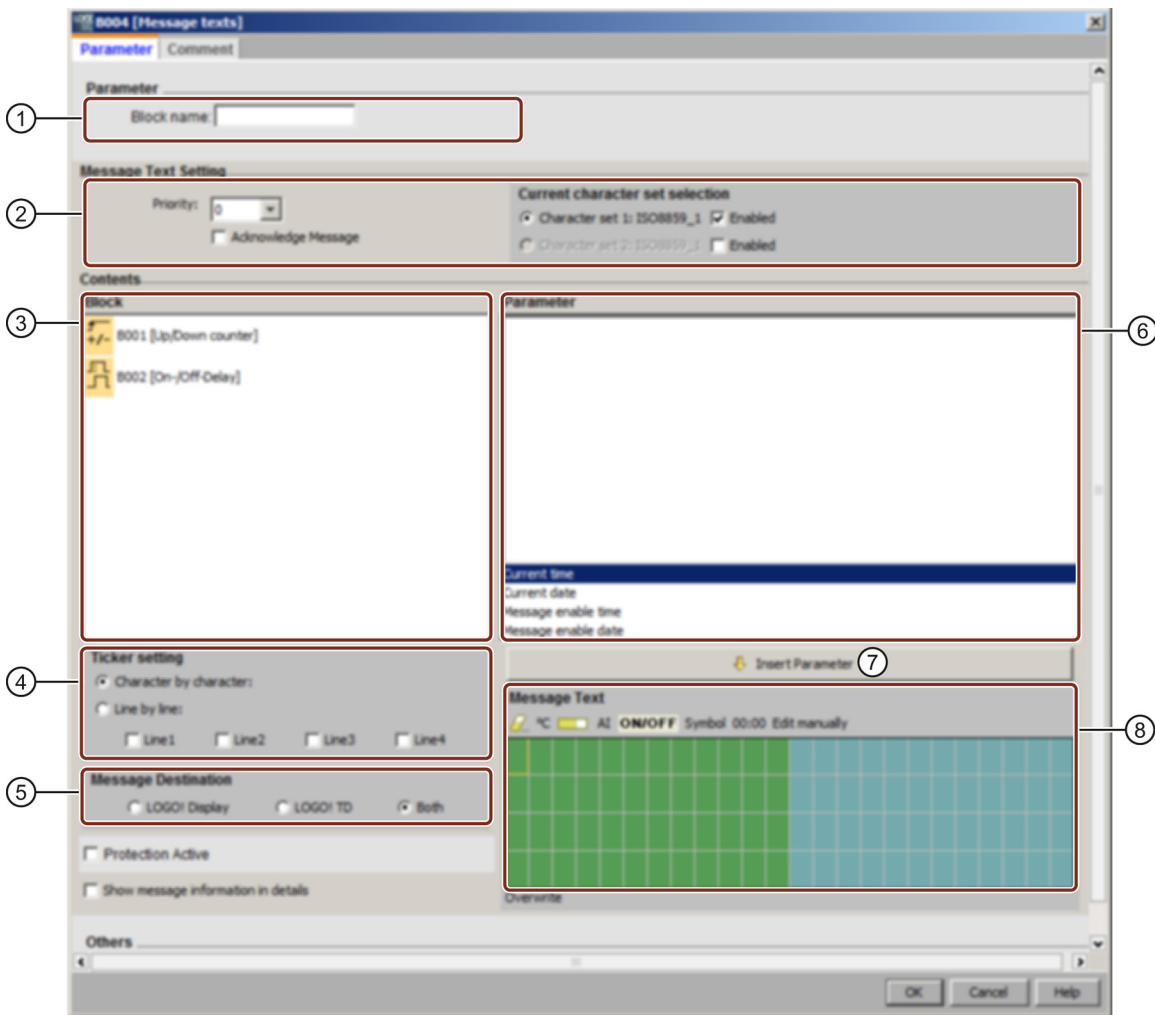

After a message text is disabled or acknowledged, the display automatically shows the previously active message text with the highest priority.

You can change between the display in RUN mode and the message texts by means of the ▲ and ▼ buttons.

Particular characteristics to be noted when configuring



- ① **Block name area**
Here you can provide a name for the block
- ② **Settings area**
Here you can configure the following settings:
 - Priority of the message text
 - Acknowledge Message check box: if set requires a message to be acknowledged in order to be closed
 - Character set selection for the message text
- ③ **Block area**
Here is where you select blocks from all of the blocks in the circuit program. You can subsequently choose parameters from these blocks to display in the message text.
- ④ **Tick area**
Here you define the tick parameters for the message text:
 - Character by Character tick format
 - Line by Line tick format
 - Tick enabled checkbox for each display line

- ⑤ **Message destination area**
Here you choose whether the target destination for the message is the LOGO! onboard display, the LOGO! TD, or both.
- ⑥ **Block parameters area**
Here you can select the parameters to be displayed in the message text from the block that is selected in the block area.
- ⑦ **Insert Parameter button**
This button is for inserting a selected block parameter into the message text.
- ⑧ **Message area**
Here you arrange the message text. The information that you enter in this area corresponds to what will be displayed on the LOGO! onboard display or LOGO! TD.
Above this area are additional buttons:
-  **Delete button:** for deleting entries from the message area
 -  **Special characters button:** for inserting special characters into the message area
 -  **Bar Graph button:** for placing a horizontal or vertical bar graph into the message area
 -  **AI button:** for placing an analog input value into the message area
 -  **ON/OFF button:** for specifying a digital value to be represented by one of two strings corresponding to the 0 state and 1 state, for example "OFF" and "ON".
 -  **Edit manually button:** for using the static editor to add, move, or delete message text elements without changing the position of any other elements.
- For LOGO! 0BA7 only:**
-  **Symbol button:** for opening the virtual keyboard panel. You can insert characters of current character set.
 -  **Scale time button:** for referencing an actual value and showing it in a specified time base format.

To arrange the message text

The message area shows a grid of four lines and character positions. The message text configuration area is 24 characters wide for Western European character sets or 16 characters wide for Asian character sets. Either way, the character width of each line is double that of the LOGO! onboard display or LOGO! TD. Message lines that are longer than the width of the actual display can be set to "tick". In the message area, LOGO!Soft Comfort indicates the region corresponding to the visible area of the LOGO! onboard display or LOGO! TD in one color, and the region that can only be shown by using the message ticking feature in another color.

To configure the content of a message text, follow these steps:

1. From the "Block" area, select the block whose parameters you want to output.
2. Drag and drop the parameters required from the "Parameter" area to the "Message Text" area. You can also use the "Insert Parameter" button to insert a parameter value.
3. In the "Message Text" area, you can add parameter data, time or date values from the block parameter area as required and enter text. To enter text, select the character set for the message text, and then type. You can also use the buttons above the message text area to add special characters, bar graphs, analog input values, and names for digital I/O states.

Message text character set

LOGO! 0BA6 and higher versions support five character sets for messages. Of these, you can select two for the display of message texts with the **File → Message Text Settings** (Page 52) menu command or from the "Msg Config" menu of LOGO!. Of the fifty possible message texts that you can configure, you can select any number of them to be from the first language and any number from the second language. For example, you could configure fifty message text function blocks that have a single message text for Character Set 1. Alternatively, you could configure twenty-five message text function blocks, each of which has two message texts: one for Character Set 1 and one for Character Set 2. Any combination is valid such that the total does not exceed fifty.

The Message text dialog displays the character sets that are currently available for your message text, as configured in the message text settings. To use a character set, select the "Enabled" check box, and the button for the character set. Characters that you subsequently type will be from the character set that you enabled and selected. If you deselect the "Enabled" check box for a character set, LOGO!Soft Comfort will prompt you for confirmation and then delete the message text, if it exists, that corresponds to that character set.

The character set of a message text is independent of the language setting for the LOGO! onboard display menus. They can be different.

Chinese character set

The LOGO! Base Module and LOGO! TD support the Chinese character set (GB-2312) for the People's Republic of China. The devices use Microsoft Windows encoding for this character set. The Windows encoding allows the devices to display the same characters as shown in the LOGO!Soft Comfort message text editor when you are using a Chinese emulator or a Chinese version of Microsoft Windows.

The Chinese character set requires a Chinese version of Windows or a Chinese emulator to properly display Chinese characters in the LOGO!Soft Comfort message text editor. You must start the Chinese emulator before you open the the message text function block in LOGO!Soft Comfort.

Message ticker

You can configure a message text to tick, or to not tick. Two types of message ticking exist:

- Character by character
- Line by line

Messages that tick character by character scroll off the characters of the message line one character at a time to the left with the additional characters scrolling in one at a time from the right. The time interval for the tick is specified by the TickTime message text setting.

Messages that tick line by line by line scroll one half of the message off the display to the left with the second half of the message scrolling in from the right. The time interval for the tick is ten times the TickTime parameter. The two halves of the message simply alternate on the LOGO! onboard display or LOGO! TD.

The tick time is the interval of time by which a character or a line of text ticks off the screen. The tick time is a global message text parameter for all message texts.

Example: Tick Message Character by Character

The following illustration shows the configuration in LOGO!Soft Comfort of a one-line, 24-character message text:

X1	X2	X3	X4	X5	X6	X7	X8	X9	X10	X11	X12	X13	X14	X15	X16	X17	X18	X19	X20	X21	X22	X23	X24

If you set this message to tick "character by character" with a tick interval of 0.1 seconds, then the initial appearance of this message line on the LOGO! onboard display or LOGO! TD is as shown in this illustration:

X1	X2	X3	X4	X5	X6	X7	X8	X9	X10	X11	X12	X13	X14	X15	X16	X17	X18	X19	X20	X21	X22	X23	X24
----	----	----	----	----	----	----	----	----	-----	-----	-----	-----	-----	-----	-----	-----	-----	-----	-----	-----	-----	-----	-----

After 0.1 second, one character of the message line ticks. The message appears as follows on the LOGO! onboard display or LOGO! TD:

X2	X3	X4	X5	X6	X7	X8	X9	X10	X11	X12	X13	X14	X15	X16	X17	X18	X19	X20	X21	X22	X23	X24	X1
----	----	----	----	----	----	----	----	-----	-----	-----	-----	-----	-----	-----	-----	-----	-----	-----	-----	-----	-----	-----	----

After the next 0.1 second, another character of the message line ticks. The message appears as follows on the LOGO! onboard display or LOGO! TD:

X3	X4	X5	X6	X7	X8	X9	X10	X11	X12	X13	X14	X15	X16	X17	X18	X19	X20	X21	X22	X23	X24	X1	X2
----	----	----	----	----	----	----	-----	-----	-----	-----	-----	-----	-----	-----	-----	-----	-----	-----	-----	-----	-----	----	----

Example: Tick Message Line by Line

The following example uses the same message configuration as the previous example:

X1	X2	X3	X4	X5	X6	X7	X8	X9	X10	X11	X12	X13	X14	X15	X16	X17	X18	X19	X20	X21	X22	X23	X24

If you set this message to tick "line by line" with a tick interval of 0.1 seconds, then the initial appearance of this message on the LOGO! onboard display or LOGO! TD is the left half of the message as shown in this illustration:

X1	X2	X3	X4	X5	X6	X7	X8	X9	X10	X11	X12	X13	X14	X15	X16	X17	X18	X19	X20	X21	X22	X23	X24
----	----	----	----	----	----	----	----	----	-----	-----	-----	-----	-----	-----	-----	-----	-----	-----	-----	-----	-----	-----	-----

After 1 second (10 x 0.1 second), the message ticks to show the right half of the message as shown in this illustration:

X13	X14	X15	X16	X17	X18	X19	X20	X21	X22	X23	X24	X1	X2	X3	X4	X5	X6	X7	X8	X9	X10	X11	X12
-----	-----	-----	-----	-----	-----	-----	-----	-----	-----	-----	-----	----	----	----	----	----	----	----	----	----	-----	-----	-----

The screen display alternates between the two message halves every second.

You can configure each individual line of a message text to tick or not to tick at all. The "character by character" or "line by line" setting applies to all lines that you configure to tick. Select the check box beside a line number to enable ticking for that line.

Bar graphs

You can specify a bar graph representation for the actual value of any other function block in your circuit program. The bar graph can be horizontal or vertical on the LOGO! onboard display or LOGO! TD. You can configure up to four bar graphs per message text.

Use the bar graph button  in the message text area to place a bar graph in the message text area. From the Bar Setting dialog you must provide the following information:

- Block from your circuit program that the bar graph represents
- Minimum and maximum value for the bar graph: LOGO! will calculate the length or height of the bar graph by scaling the actual value between the minimum and maximum values.
- Orientation of the bar graph: horizontal or vertical
- Width or height of the bar graph, in character spaces

Example:

Consider a bar graph in a message text with the following characteristics:

- Configured bar graph length: 4 character spaces
- Orientation: Horizontal
- Configured minimum value: 1000
- Configured maximum value: 2000
- Actual value: 1750

The resulting bar graph will be 3 character spaces long.

Text representation of digital I/O states

You can assign names such as "On" or "Off" to the two states of a digital input or output. With the LOGO! 0BA6 and 0BA7 series, you can display this name of a digital I/O state in a message text. The maximum number of characters for a state name is eight for Western language character sets; for Asian language character sets the number of characters is four. Use the ON/OFF button in the message text area to define names for the two states of a digital input or output to be used in the message text.

Within a single message text, you can configure up to four digital I/O state name displays.

Within one circuit program, a maximum of 20 I/O state names can be used in message text function blocks.

Display of remaining timer time

With the LOGO! 0BA6 series, you can display the remaining time of a timer in a message text. Prior to this feature you could display the current elapsed time of a timer and the timer parameters.

When placed in a message text, the remaining time will show the time that remains before the timer expires. For timers with multiple timer values (for example on-delay time, off-delay time), you can display the remaining time of each one in a message text.

Display of analog inputs

You can also select analog inputs to be displayed in a message text. Use the AI button in the message text area to select a specific AI to place in the message text area.

If you have analog inputs in a message text, the global message text setting (Page 52) for the Analog input filter timer specified how often the message text is updated with current values. The refresh time choices are 100 ms, 200 ms, 400 ms, 800 ms, and 1000 ms. If you have more than one analog input in a message text, the refresh rate applies to them all.

Static editor (Edit manually)

LOGO!Soft Comfort provides a static editor for message texts that can help when you need to reposition text elements. For example, it has a recycle bin area where you can temporarily move message text elements in order to rearrange the position of elements on the display area. You can move elements up, down, left, or right without changing the position of any other elements.

To use the static editor, click the "Edit manually" button above the message text area. You will also be prompted to edit manually if you try to place or move elements in the message area that have a position conflict with existing elements.



OBA0-OBA3:

Maximum number of message texts: 5

Not supported: message ticker, bar graphs, analog inputs, I/O status names, and remaining timer time.

OBA4-OBA5:

Maximum number of message texts: 10

Not supported: message ticker, bar graphs, analog inputs, I/O status names, and remaining timer time.

Virtual keyboard

You can access the virtual keyboard by clicking the **Symbol** button above the message text menu. The virtual keyboard dialog is shown as follows:

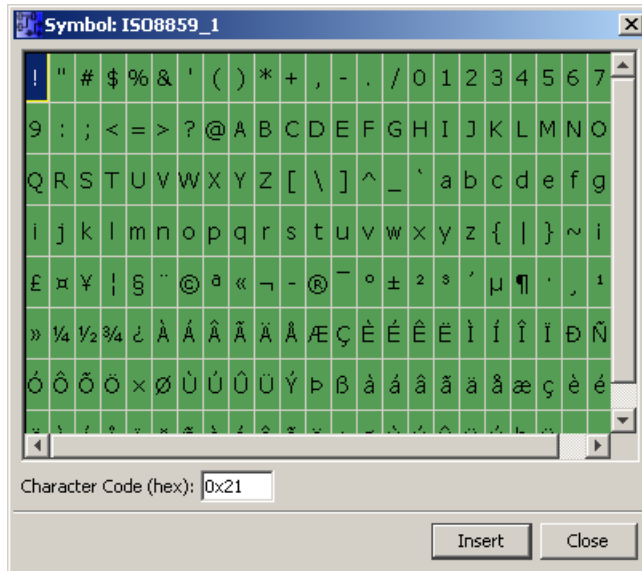

The virtual keyboard displays some of the characters of the current character set. When you select a character, you can view its corresponding character code in the "Character Code (hex)" field. To insert the selected character, click the "Insert" button.

LOGO! does not support all of the characters of all of the character sets. For SJIS character set, the supported code area is [0x21, 0x7E] && [0xA1, 0xDF], and for other character sets, the supported code area is [0x21, 0x7E] && [0xA1, 0xFF]. You can find the detailed descriptions of the supported characters and their character codes on the DVD for LOGO!Soft Comfort.

Scale time

To configure the time scale for a function block, click **00:00** button to display the "Scale time setting" dialog:

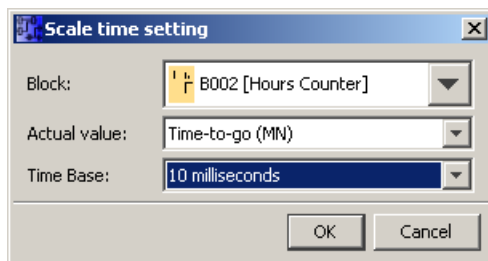

With this dialog, you can configure the scale time base for a function block value. You select a function block, an actual value and a time base, and click "OK" to confirm your settings.

The calculation for displaying a time value in a message text based on the configured time base is shown below, where "C" represents the actual value:

Time base of message text	Time format	Calculation for time value
Hour	xx	C
Minute	xx : xx	$C / 60 : C \% 60$
Second	xx : xx : xx	$(C / 60) / 60 : (C / 60) \% 60 : C \% 60$
10 milliseconds	xx : xx : xx : xx	$C / 100 / 60 / 60 : ((C / 100 / 60) \% 60 : (C / 100) \% 60 : C \% 100$

/: Integer division

?: Remainder of integer division

Copying and pasting text characters

Whenever you enter characters into the message text area or into the I/O status name text edit area, you can use the keyboard shortcuts for copy (Ctrl-c) and paste (Ctrl-v). You can copy and paste characters between any document on your computer, text in a message text, text in an I/O status name, or text in the LOGO! TD Power-up screen (Page 82) text edit area. LOGO!Soft Comfort verifies that any characters to be pasted are valid for the selected character set. Only character entry areas of text messages, I/O status names, and the LOGO! TD Power-up screen support copy and paste. You cannot, for example, copy and paste bar graphs, function block parameters, or anything other than text characters of the selected character set.

You cannot use Ctrl-x to cut characters for pasting, except from a document on your computer. LOGO!Soft Comfort does not support the cut operation from the message text, I/O status name, or LOGO! TD Power-up screen editing dialogs.



LOGO!Soft Comfort V7.0 keeps the text information when you copy and paste a Message text function block.

If you paste a Message text function block to another circuit program with a different character set, LOGO!Soft Comfort keeps only the characters of the character set of the circuit program into which you are pasting. LOGO!Soft Comfort displays a "?" in place of the unsupported characters.

Message text after changing the character set

LOGO!Soft Comfort V7.0 keeps the text information when you change the character set.

LOGO!Soft Comfort keeps only the characters supported by the current character set, and displays a "?" in place of the unsupported characters.

Restrictions

The following restrictions apply to message text function blocks:

- Up to 50 message text functions are available.
- Up to 32 total bar graphs in message texts are available.
- LOGO!Soft Comfort supports all of the defined features for message texts. When programming directly on the LOGO! device, you can only program a limited number of the

message text features. See the *LOGO! Manual* for a description of message text programming from the LOGO! device.

- Each message line can contain 24 characters (Western language character sets) or 16 characters (Asian language character sets). Within a message text the following limitations apply:
 - Maximum number of parameters: 4
 - Maximum number of bar graphs: 4
 - Maximum number of I/O status names: 4 for LOGO! 0BA6 devices; LOGO! 0BA7 devices support a maximum of eight I/O status names in one message text function block, and a maximum of 40 I/O status names in all message text function blocks.
 - Maximum number of time/date values: 4
 - Maximum number of analog inputs: 2

Particular characteristics to be noted when configuring

The message text can be configured in the block properties dialog. You can enter up to four lines for each message text (the text display of the LOGO! onboard display and LOGO! TD has four rows) and set the priority. You can move to the next line using the cursor keys or the mouse. Hit the [ENTER] key to confirm all your entries in the block properties dialog and to close the dialog.

You can also specify the actual values of other blocks in the text lines. To do so, select the relevant block from the **Block** dialog. A **Parameter** dialog opens to display a list of all parameters available for the selected block. The block parameter you select in this dialog is written to the selected text line. The actual parameter value is now included when you call the message text.

Set the "Acknowledge message" attribute to specify whether a message is be acknowledged before it is closed.

Simulation mode

Layout of message texts (Page 143)

Message online test (0BA7 only)

With the message online test function, you can view the same message texts as shown in the LOGO! Base Module.

You can start or stop messages online by clicking the  toggle button, and the messages are displayed as follows:



During a message online test, you cannot use LOGO!Soft Comfort to edit message text parameters, change the character set, acknowledge a message text, or shift a message text. You can, however, use the "Go to block" button.

Special Functions Overview (Page 212)

See also

Message text (LOGO! 0BA4 and LOGO! 0BA5) (Page 327)

5.3.6.5 Message text (LOGO! 0BA4 and LOGO! 0BA5)

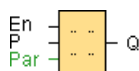

Short description

This function displays message texts and parameters of other blocks on the LOGO! onboard display when LOGO! is in **RUN** mode.

Connection	Description
Input En	A 0 to 1 transition at En (Enable) triggers the output of the message text.
Input P	P is the priority of the message text. 0 is the lowest, 30 the highest priority Ack: Acknowledgement of the message text
Parameter	Text: Input of the message text Par: Parameter or actual value of another, already configured function (see "Visible parameters or actual values") Time: Shows the continuously updated time-of-day Date: Shows the continuously updated date EnTime: Shows the time of the 0 to 1 transition EnDate: Shows the 0 to 1 transition of the date
Output Q	Q remains set as long as the message text is queued.

Description of the function

With a 0 to 1 transition of the signal at input En, the display outputs your configured message text (actual value, text, TOD, date) in RUN mode.

Acknowledgement disabled (Ack = Off):

The message text is hidden with a 0 to 1 signal transition at input En.

Acknowledgement enabled (Ack = On):

After input En is reset to 0, the message text is displayed until acknowledged by pressing the OK button. The message text cannot be acknowledged as long as input En is high.

If several message text functions were triggered with En=1, the message with the highest priority (0 = lowest, 30 = highest) is displayed. This also implies that a new message text is only displayed if its priority is higher than that of previously enabled message texts.

After a message text is disabled or acknowledged, the function automatically shows the previously active message text that takes the highest priority.

You can change between the display in RUN mode and the message texts by means of the ▲ and ▼ buttons.

Restrictions

Up to ten message text functions are available.

Particular characteristics to be noted when configuring

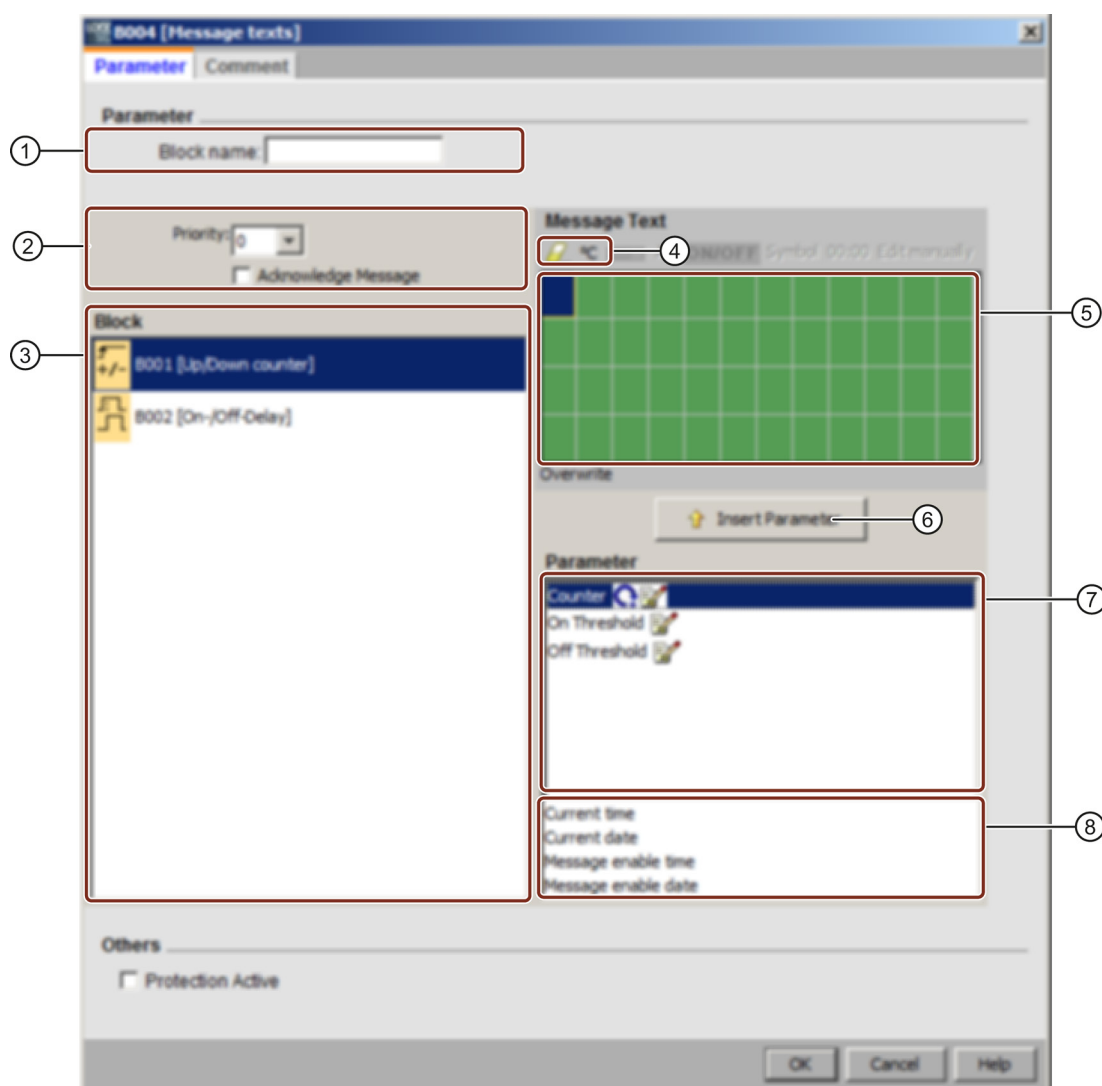

- ① **Block name area**
Here you can provide a name for the block.
- ② **Setting area**
Here you will find the following settings:
 - Priority of the message text
 - Check box for message text acknowledgment
- ③ **Block area**
Here is where you select blocks from all of the blocks in the circuit program. You can subsequently choose parameters from these blocks to display in the message text.
- ④ **Delete button**
Button for deleting entries from the **message area**
- Special characters button**
Button for inserting special characters in the **message area**

- ⑤ **Message area**
You arrange the message text in this area. Information entered in this area corresponds with that on the LOGO! onboard display.
- ⑥ **Insert button**
Button for inserting a selected block parameter into the message text.
- ⑦ **Block parameter area**
Shows the parameters of a block selected from the **block area** which you can output in the message text.
- ⑧ **General parameter area**
Shows general parameters such as the current date.

To arrange the message text

1. From the **"Block"** area, select the block whose parameters you want to output.
2. Drag and drop the parameters required from the **block parameters** to the **messages area**. You may also use the **"Insert"** button to do so.
3. In the **messages area**, you can add parameter data as required.

Simulation mode

Layout of message texts (Page 143)

Special functions (Page 212)

5.3.6.6 Message text (LOGO! 0BA2 and LOGO! 0BA3)



The message text is only available for devices as of hardware series 0BA2.

Short description

Display of a configured message text in RUN mode.

Connection	Description
Input En	The message text is output with a 0 to 1 transition at input En (Enable).
Parameter P	P is the priority of the message text. 0 is the lowest, 9 the highest priority.
Parameter	Par: Parameter or actual value of another, already programmed function (see "Displayable parameters or actual values")
Output Q	Q remains set as long as the message text is queued.

Description of the function

In RUN mode, a 0 to 1 transition of the signal at input En triggers the output of your configured message text on the display. The message text is closed after a 1 to 0 transition at input En and if the acknowledgment attribute is not set. If the acknowledgment attribute is set, the message text is not closed until input En=0 and the message is acknowledged at the LOGO! with OK. The status at output Q remains 1 as long as the message text is displayed.

Of several message text functions triggered with En=1, the one with the highest priority is displayed. Low-priority messages can also be displayed by pressing the ▼ button on the LOGO!.

You can switch between the standard display and the message text display by means of the LOGO! buttons ▲ and ▼.

Restrictions

Up to five message text functions are available.

Particular characteristics to be noted when configuring

The message text can be configured in the block properties dialog. You can enter up to four lines for each message text (the text display of the LOGO! has four rows) and set the priority. You can move to the next line using the cursor keys or the mouse. Hit the [ENTER] key to confirm all your entries in the block properties dialog and to close the dialog.

You may also enter the actual values of other blocks in the text lines. To do so, select the relevant block from the **Block** dialog. A **Parameter** dialog opens to display a list of all parameters available for the selected block. The block parameter you select in this dialog is written to the selected text line. The actual parameter value is now included when you call the message text.

Set the "Acknowledge message" attribute to specify whether a message is be acknowledged before it is closed.

Simulation mode

Layout of message texts (Page 143)

Special functions (Page 212)

5.3.6.7 Softkey



Short description

This SFB provides the action of a mechanical pushbutton or switch.

Connection	Description
Input En	Output Q is set with a 0 to 1 signal transition at input En (Enable) and if in addition, 'Status=On' has been confirmed in configuration mode.
Parameter	<p>Switch: Sets either a momentary pushbutton action for one cycle (On) or a switching action of the function (Off).</p> <p>Status: On or Off state that is applied in the initial cycle after program startup, if retentivity is not set.</p> <p>Retentivity set (on) = the status is retentive in memory.</p>
Output Q	<p>Output Q remains set 1, as long as En=1 and the status at the parameter Type = Switch and Status = On.</p> <p>Output Q is set for the duration of one cycle if EN=1. Switch = On (momentary pushbutton) and Status = On.</p>

Factory state

The default of the Switch parameter is switching action.

Timing diagram

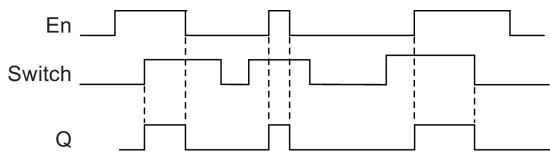

Description of the function

The output is set when input En is set and the 'Status' parameter is set to 'On' and confirmed with OK. This action is performed irrespective of a configured switch or pushbutton function.

The output is reset to '0' in the following three cases:

- With a 1 to 0 signal transition at input En
- When a pushbutton function is configured and one cycle has expired after its actuation
- When the 'Status' parameter sets the 'Off' status in configuration mode, and this has been confirmed with OK

Particular characteristics to be noted when configuring

The softkey can be used both with momentary pushbutton or switching action. At the status parameter you can define the on (actuated) or off state for the switch/pushbutton.

If the softkey is assigned a pushbutton action, the output is always set for the duration of one cycle with a 0 to 1 transition at input En when the pushbutton is in on state, or if the pushbutton state changes from Off to On when En=1.

Special functions (Page 212)

5.3.6.8 Shift register (0BA7 to 0BA8)



Short description

The shift register function reads an input value and shifts the bits. The output value corresponds with the configured shift register bit. The shift direction can be changed at a special input.

For LOGO! 0BA6, you can use only one shift register in one circuit program, but for LOGO! 0BA7 and LOGO! 0BA8 devices, you can use a maximum of four shift registers with eight bits for each shift register in one circuit program.

Connection	Description
Input In	The function when started reads this input value.
Input Trg	The SFB is started with a positive edge (0 to 1 transition) at input Trg (Trigger). A 1 to 0 transition is irrelevant.
Input Dir	You define the shift direction of the shift register bits Sx.1 to Sx.8 at the Dir input: Dir = 0: shift up (Sx.1 >> Sx.8) Dir = 1: shift down (Sx.8 >> Sx.1) NOTE: "x" refers to the index of the shift register.
Parameter	Shift register index: the index of shift register in the circuit program. Possible settings: 1 to 4 Shift register bit that determines the value of output Q. Possible settings: 1 to 8 Retentivity set (on) = the status is retentive in memory.
Output Q	The output value corresponds with the configured shift register bit.

- Dir = 0 (Shift up): Sx.1 accepts the value of input In, the previous value of Sx.1 is shifted to Sx.2, Sx.2 to Sx.3 ... Sx.7 to Sx.8
- Dir = 1 (Shift down): Sx.8 accepts the value of input In; the previous value of S1.8 is shifted to Sx.7, Sx.7 to Sx.6 ... Sx.2 to Sx.1.

Q outputs the value of the configured shift register bits.

If retentivity is not enabled, the shift function restarts at Sx.1 or Sx.8 after a power failure.

Special functions (Page 212)

5.3.6.9 Shift register (0BA4 to 0BA6)



Short description

The shift register function reads an input value and shifts the bits. The output value corresponds with the configured shift register bit. The shift direction can be changed at a special input. For device series 0BA4 to 0BA6, you can use only one shift register in one circuit program.

Connection	Description
Input In	The function when started reads this input value.
Input Trg	The SFB is started with a positive edge (0 to 1 transition) at input Trg (Trigger). A 1 to 0 transition is irrelevant.
Input Dir	You define the shift direction of the shift register bits S1...S8 at the Dir input: Dir = 0: shift up (S1 >> S8) Dir = 1: shift down (S8 >> S1)
Parameter	Shift register bit that determines the value of output Q. Possible settings: S1 to S8 Retentivity set (on) = the status is retentive in memory.
Output Q	The output value corresponds with the configured shift register bit.

5.3.6.10 Mathematic instruction error detection

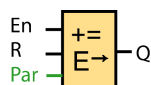

Short description

The mathematic instruction error detection block sets an output if an error has occurred in the referenced mathematic instruction function block.

Connection	Description
Input En	Enable the mathematic instruction error detection function block.
Input R	Reset the output.
Parameter	Referenced FB: block number of a mathematic instruction Error to detect: Zero division, Overflow, or Zero division OR Overflow. Auto Reset: Reset the output when the failure condition clears.
Output Q	Q is set high if the error to detect occurred in the last execution of the referenced mathematic instruction function block.



0BA1- 0BA5:

The mathematic instruction error detection function block did not exist prior to 0BA6.

Parameter Referenced FB

The value for the Referenced FB parameter references the block number of an already-programmed mathematic instruction function block.

Description of the function

The mathematic instruction error detection block sets the output when the referenced Mathematic instruction function block has an error. You can program the function to set the output on a zero division error, an overflow error, or when either type of error occurs.

If you select the "Automatically reset" check box, the output is reset prior to the next execution of the function block. If not, the output retains its state until the mathematic instruction error detection block is reset with the R parameter.

In any scan cycle, if the referenced mathematic instruction function block executes before the mathematic instruction error detection function block, the error is detected in the same scan cycle. If the referenced mathematic instruction function block executes after the mathematic instruction error detection function block, the error is detected in the next scan cycle.

Mathematic instruction error detection logic table

In the table below, Error to Detect represents the parameter of the mathematic instruction error detection instruction that selects which type of error to detect. Zero represents the zero division bit set by the mathematic instruction at the end of its execution: 1 if the error occurred, 0 if not. OF represents the overflow bit set by the mathematic instruction: 1 if the error occurred, 0 if not. Zero division OR Overflow represents the logical OR of the zero division bit and the overflow bit of the referenced mathematic instruction. Output (Q) represents the output of the mathematic instruction error detection function. An "x" indicates that the bit can be either 0 or 1 with no influence on the output.

Error to Detect	Zero	OF	Output (Q)
Zero division	1	x	1
Zero division	0	x	0
Overflow	x	1	1
Overflow	x	0	0
Zero division OR Overflow	1	0	1
Zero division OR Overflow	0	1	1
Zero division OR Overflow	1	1	1
Zero division OR Overflow	0	0	0

If the referenced mathematic instruction function block is null, then the output is always 0.
Special functions (Page 212)

See also

Mathematic instruction (Page 276)

5.3.6.11 Additional functions of the LAD Editor

In LAD circuit programs the AND with edge evaluation (Page 208) instruction and the NAND with edge evaluation (Page 209) instruction are available in the group of miscellaneous functions.

5.4 Data log profile (0BA7 & 0BA8 only)

5.4.1 What is a data log?



You can configure a data log to record the actual values of the function blocks and memory areas in a circuit program.

Connection	Description
En	The Data Log begins logging data with a positive edge (0 to 1 transition) at input En (Enable)

Short description

You can access the data log profile in the LOGO!Soft Comfort navigation tree:

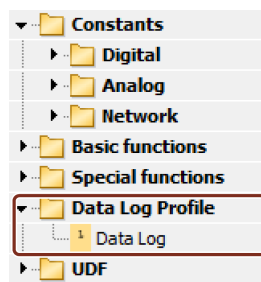

You can configure one data log per circuit program. After you configure a data log, the icon in the navigation tree becomes gray so that you can no longer select it:

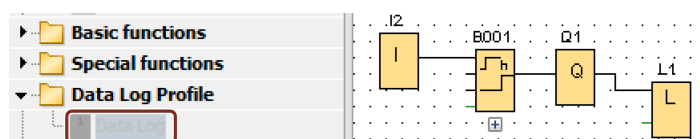

5.4.2 Configuring the data log

In a circuit program, you can only configure one data log to record the actual values of function blocks, and the following memory areas:

- I
- Q
- M
- AI

5.4 Data log profile (0BA7 & 0BA8 only)

- AQ
- AM

For digital I/O and memory, you must log data in groups of eight bits, for example, I1 to I8, Q9 to Q16, M17 to M24. For analog data, you select one value to log, for example, AI1, AQ2, or AM1. You configure function block values in groups of eight bits or single values, depending on the value type (digital or non-digital).

You can log a maximum of 32 items (analog values or eight-bit digital groups) in the data log.

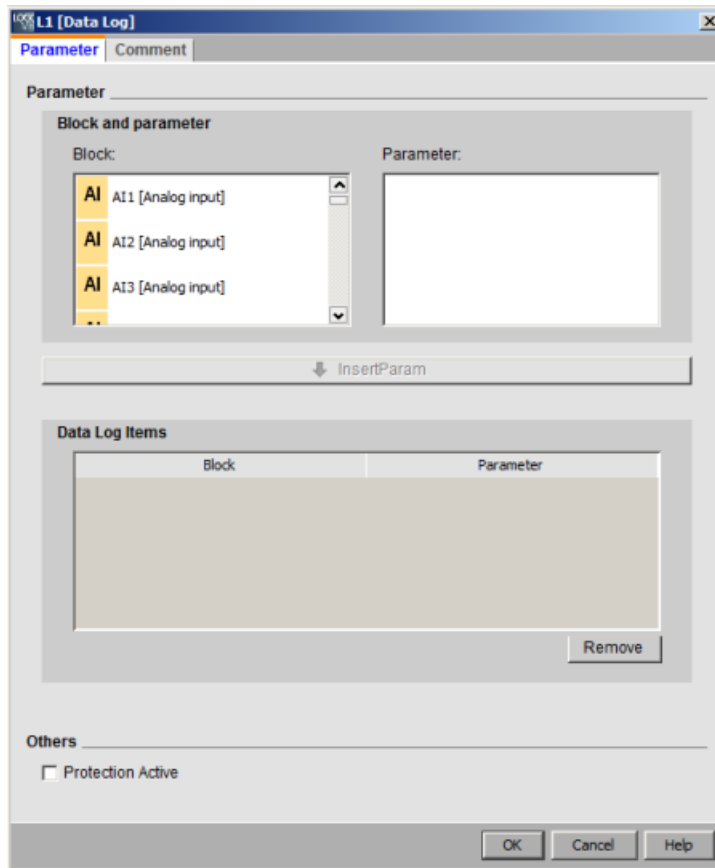

You can only configure the data log from LOGO!Soft Comfort. You can not create, configure, or delete the data log from a LOGO! device.

5.4.3 Transferring the data log

After configuring the data log, you can download the circuit program into LOGO! 0BA7 or LOGO! 0BA8 devices which store the data log in internal EEPROM.

You can transfer the data log to your PC or an SD card in .CSV format. To upload the data log from the internal EEPROM to your PC, use the menu command "Tools -> Transfer -> Upload Data Log (0BA7 and 0BA8 only) (Page 78)", and the LOGO! 0BA7 or LOGO! 0BA8 devices must be in STOP mode.

5.4.4 Opening an uploaded data log

After successfully uploading the data log into your PC, double-click this .CSV file and it opens in Microsoft Excel by default. You can also open it with a text editor regardless.

5.5 UDF (0BA7 & 0BA8 only)

5.5.1 What is a UDF?

A UDF (User-Defined Function block) provides you a convenient way to deal with circuit logic that is composed of a group of function blocks and used in several places of a circuit program or among multiple circuit programs. A UDF helps you avoid copying and pasting a common set of blocks to multiple places and results in more readable program logic with fewer connection lines. With a UDF, you can do the modifications of all occurrences of the circuit logic at just one place.

To create and use a UDF, follow these steps:

1. **Edit mode:** create and edit a UDF

- You can create a new UDF via menus or toolbars, and edit this UDF.
- You can use a group of selected blocks in an existing circuit program as the start contents of the new UDF.
- You can save the UDF to a UDF library path where you can import the UDF later.
- You can create your own UDF library or copy a UDF library from a third party.

2. **Use mode:** use the UDF in an FBD or in another UDF (nested UDF)

If you have imported the UDF, it is available in the block tree like general function blocks. You can use it in the same way as a general function block.

5.5.2 Creating a UDF

You can create an empty UDF from the File → New (Page 47) menu command.

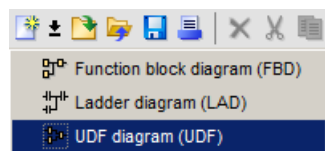

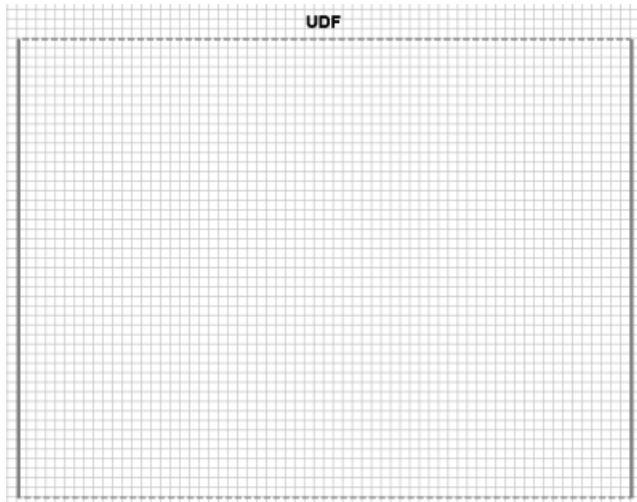

A UDF has a rectangle to indicate its edit area. You can edit the position and dimensions of this area.

Restrictions for a UDF:

- Input (analog + digital): 8
- Output (analog + digital): 4
- Parameter: 8

Note

Not all blocks can be added to a UDF. Items shown below **can not** be added to a UDF:

- Inputs
- Outputs
- Analog inputs
- Analog outputs
- M8
- M25 to M31
- Shift registers
- PI controllers
- Data Log
- Message texts

You can also create a UDF from selected figures. To create a new UDF, select the blocks, right-click, and select "①" from the following context menu.

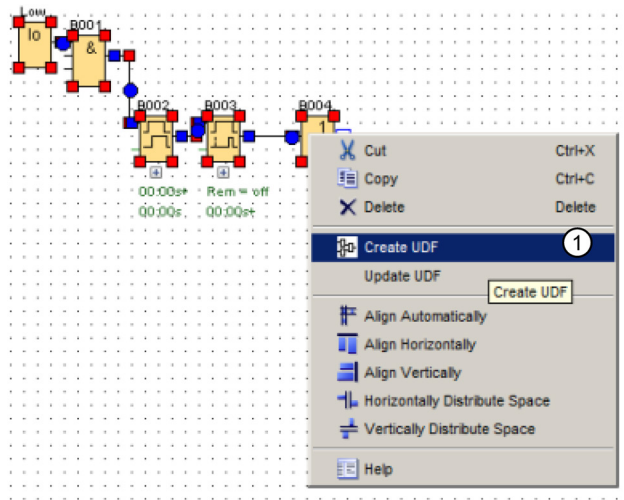

If the selection includes blocks that a UDF does not support, LOGO!Soft Comfort excludes them from the UDF. If an included function block is connected to an excluded one, LOGO!Soft Comfort creates an input or output in place of the excluded block. If the number of inputs and outputs would exceed the restrictions, LOGO!Soft Comfort does not make inputs or outputs that would exceed the restriction.

LOGO! Soft Comfort creates the UDF and opens it in the UDF Editor:

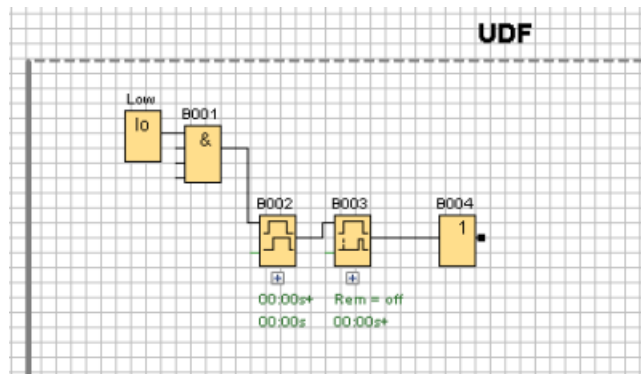

5.5.3 Editing the UDF

Add/Remove connectors

You can create an input/output by dragging a connection line from a block to the left or right side of the UDF edit rectangle area:

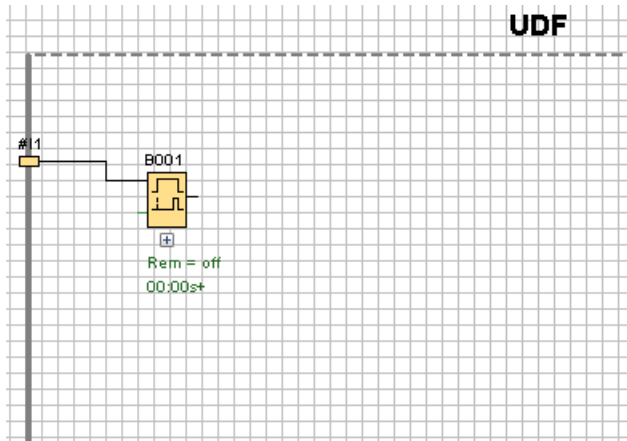

To remove an input/output, select the yellow connector figure and select "①" in the context menu. The corresponding connection line(s) will be deleted as well:

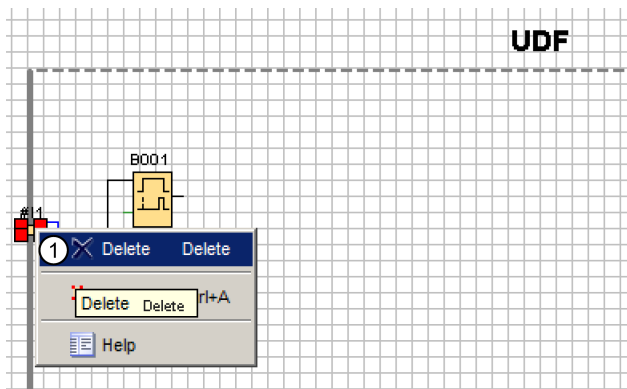

Configure UDF properties

UDF properties include information such as identifier, password, connector names, parameters, comments and so on. To edit the UDF properties, double-click the identifier text above the UDF edit box or use menu command "Edit -> Edit UDF properties (Page 65)". LOGO!Soft Comfort displays the following dialog:

The dialog box 'Edit UDF properties' is shown with the 'I/O' tab selected. It contains the following fields and tables:

Identifier: [UDF]

UDF password:

- Old password: []
- New password: []
- Repeat new password: []

Input Connectors:

Index	Identifier	Name
1	#I1	
2	#AI1	
3	#I2	

Output Connectors:

Index	Identifier	Name
1	#Q1	
2	#AQ1	
3	#Q2	

Buttons: OK, Cancel, Help

The dialog includes three tabs:

- I/O
- Parameters
- Comment

The I/O-specific tab

From this tab, you can configure the identifier, the UDF password, and the names of input connectors and output connectors:

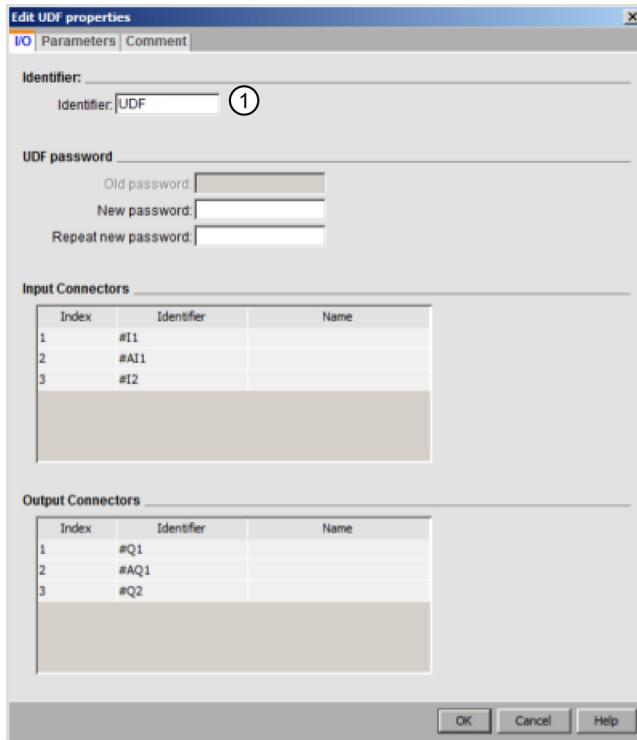

In Field "①" of the above dialog, you can enter an identifier for your UDF. The identifier is "UDF" by default.

UDF password offers the capability to hide the details of a UDF such that a UDF library can be distributed without the details. In the use mode, you can right-click the UDF, and select "②" in the following context menu list to expand the UDF and view its details:

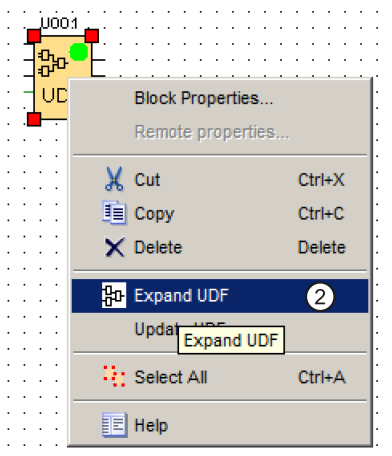

If you did not configure a password for the UDF, LOGO!Soft comfort displays the expanded UDF content when you select "①":

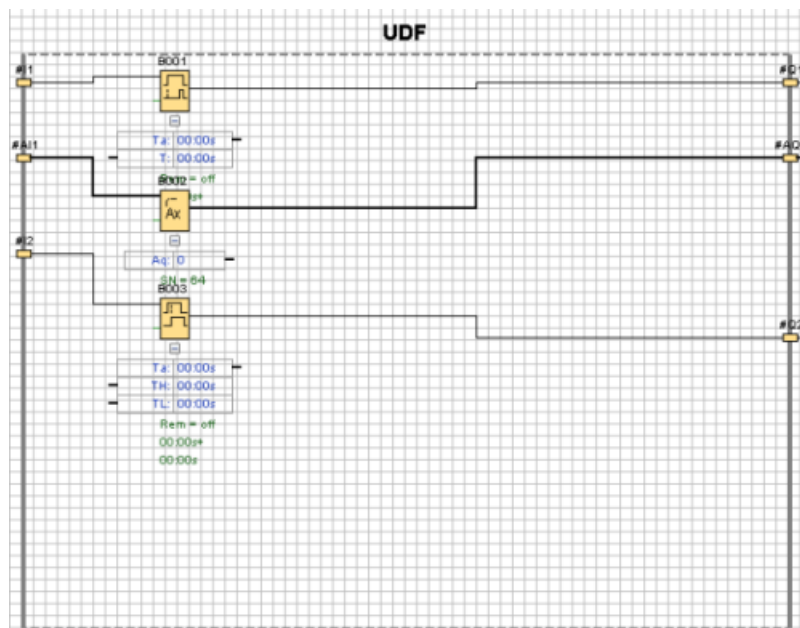

If you did configure a password for the UDF and select "①", you must first enter the password before LOGO!Soft comfort displays the expanded UDF content:

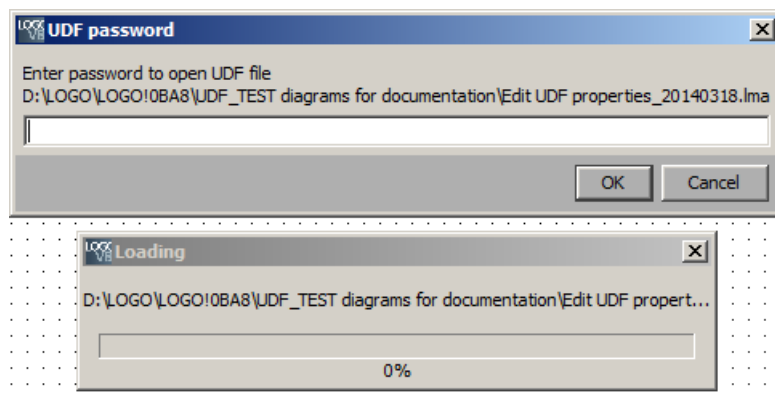

The parameter-specific tab

In this tab, you can configure the parameters of the UDF:

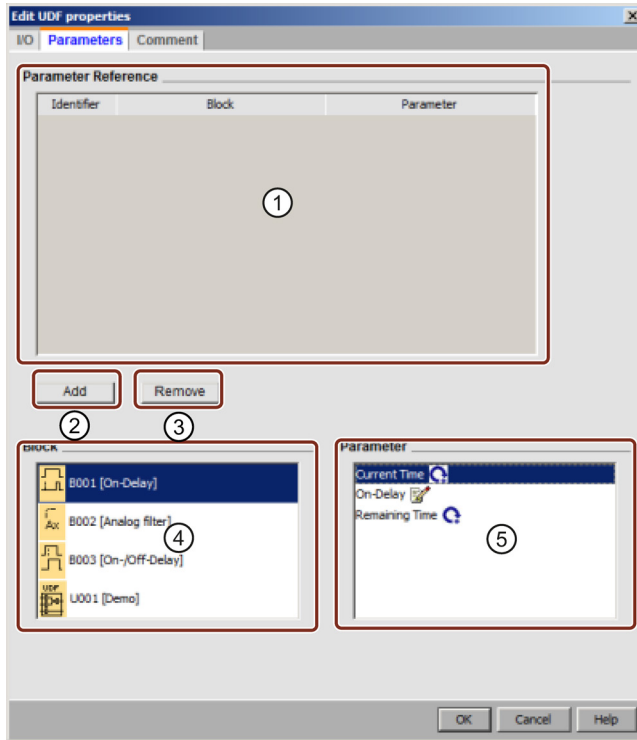

You can reference the available parameters of the function blocks used in the UDF as the parameters of the UDF. "④" shows the function blocks, while "⑤" shows the parameters that the selected block includes. Double-click a parameter or use "②" to move a parameter from "⑤" to "①".

To remove a parameter from ①, select the parameter and click ③. The parameter then reappears in ⑤.

Use the first column in ① to identify each parameter. Set a unique identifier for each parameter:

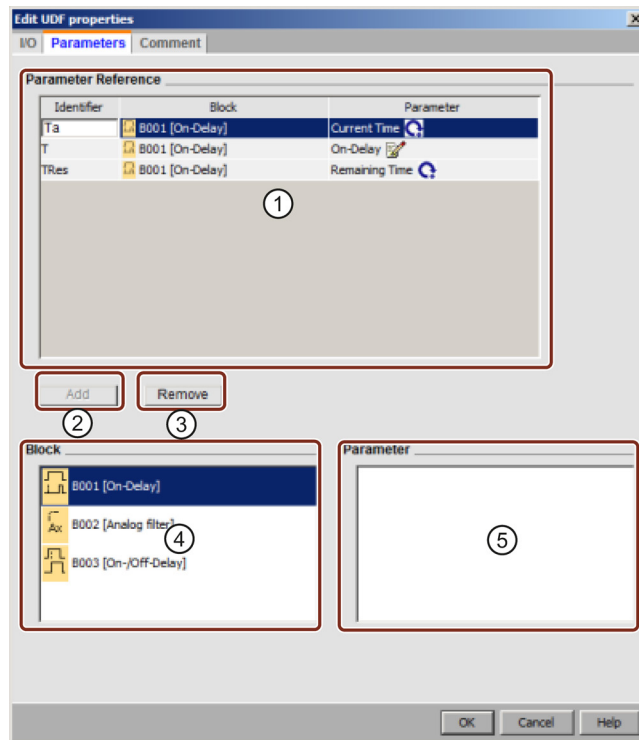

The comment-specific tab

You can use this tab to add a description of your UDF.

The comment can describe how to use the UDF, the function of the inputs and outputs, and any other details. By default, the comment appears to the right of the UDF edit box, but you can place it wherever you choose:

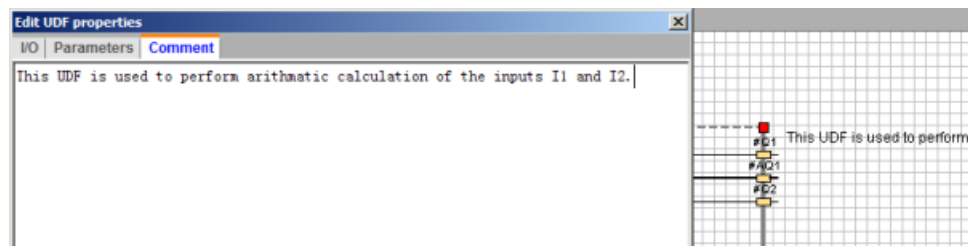

UDF identifier

The UDF identifier appears on the UDF edit box as an easy, short identifier of the UDF, and also appears in the block tree:

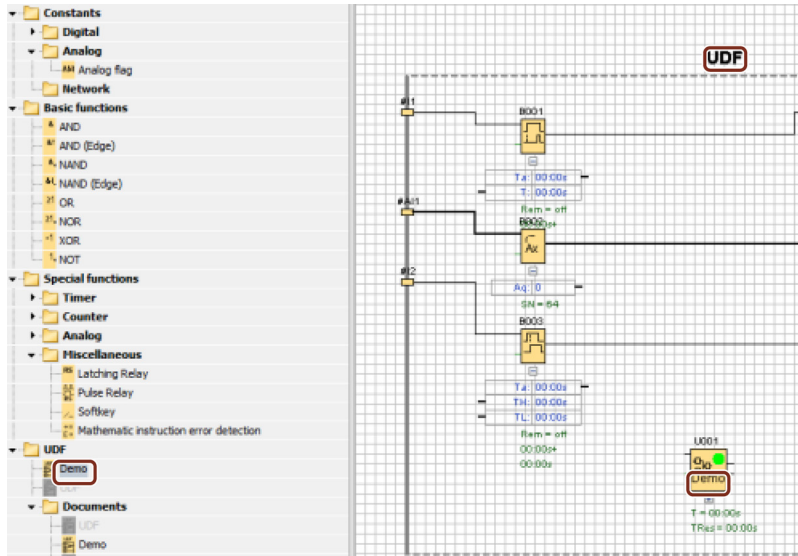

Double-click the UDF identifier above the expanded UDF to open the following properties dialog. You can enter up to eight characters for the UDF name. You can also password-protect the UDF in the following dialog:

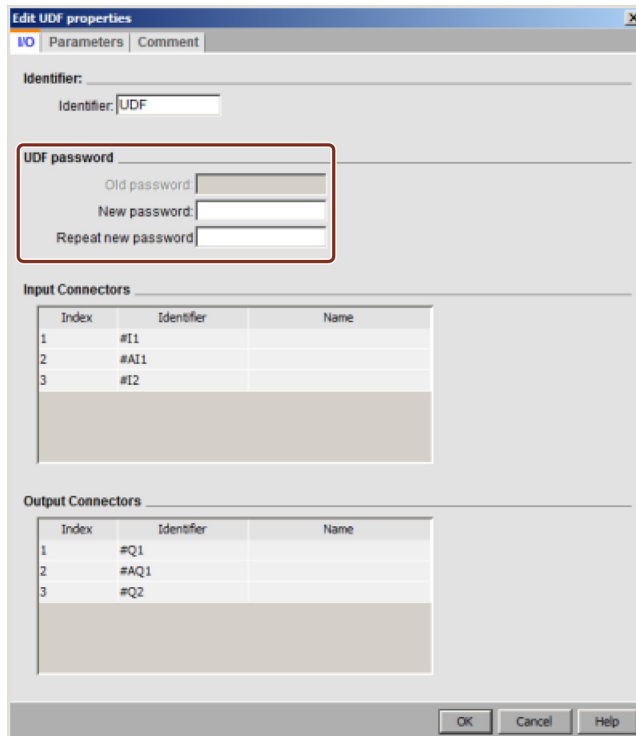

User-defined name for a UDF block

You can also configure a user-defined name for a UDF. It is the block name which appears above the UDF block as other function blocks in a circuit program.

To configure a user-defined name for the UDF, double-click the UDF block and LOGO!Soft Comfort displays the following dialog:

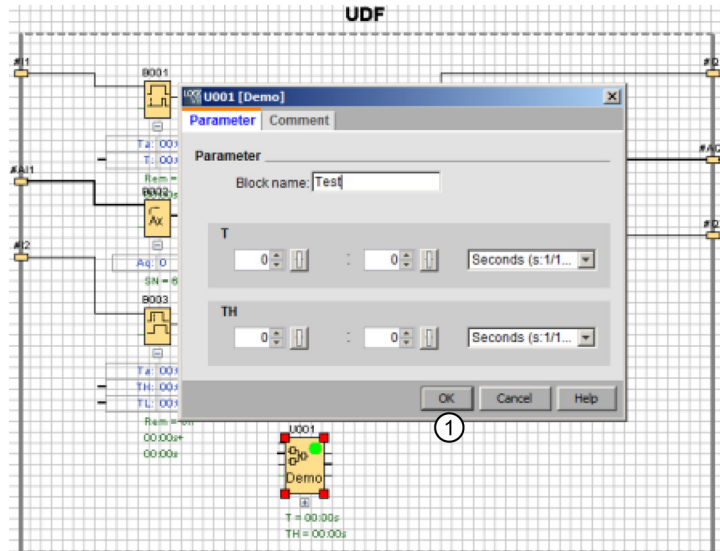

Enter a name for the UDF, and click "①" in the above dialog. Then LOGO!Soft Comfort displays the new UDF block name :

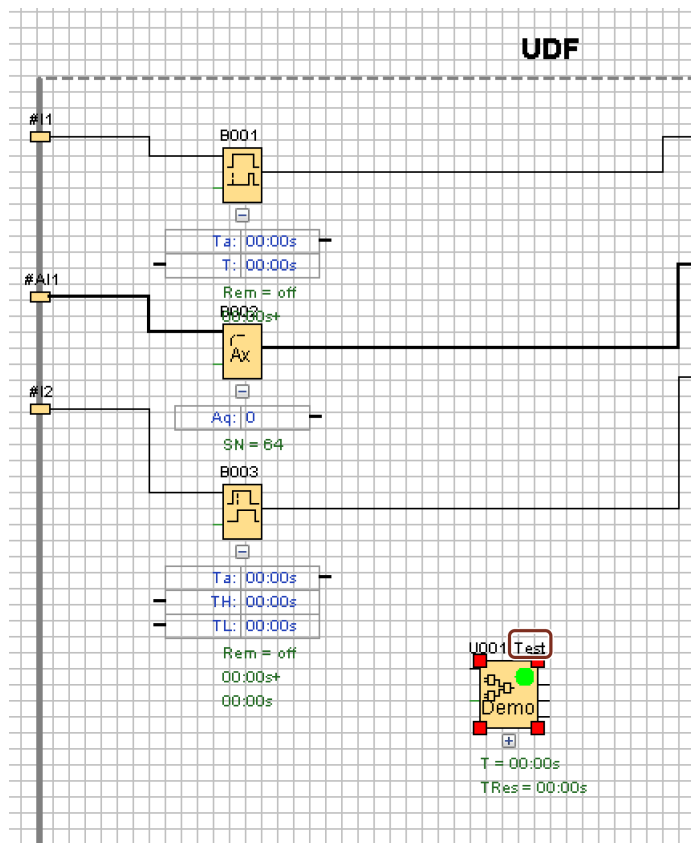

5.5.4 Saving the UDF

Saving a UDF

You can save a single UDF as .Ima file by clicking  or selecting "File -> Save (Page 49)"/"File -> Save As (Page 50)" from the menu bar.

Saving a UDF library

You can configure a UDF library structure that represents either a single UDF or a folder of multiple UDFs. See Tools -> Options:UDF (Page 122) for UDF library path configuration.

Version control in the edit mode

You can revise a UDF as needed to add new functions or to resolve logic problems. LOGO!Soft Comfort uses "version" to identify differences; the valid version range is 0.0.1 to 255.255.255. If you make any change to a UDF and click , the following dialog appears:

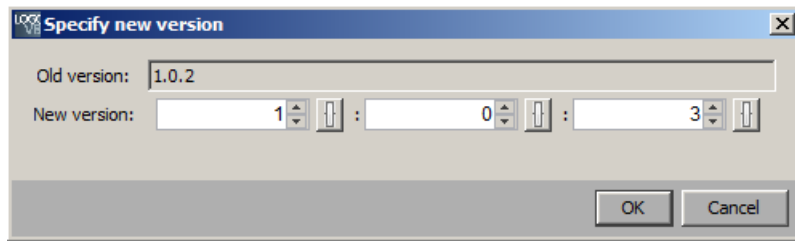

The new version must be an increment from the previous value. For example, in the example shown above, version 1.0.3 or 0.254.3 would be invalid.

5.5.5 Using the UDF in an FBD circuit program or another UDF

There are two methods available to configure a UDF library:

- Select the Tools -> Options: UDF (Page 122) menu command
- Right-click "UDF" in the following instruction tree and select "①" to call the dialog for configuring the UDF library

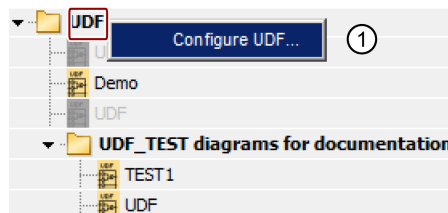

The block tree shows the UDFs and UDF library that you have configured:

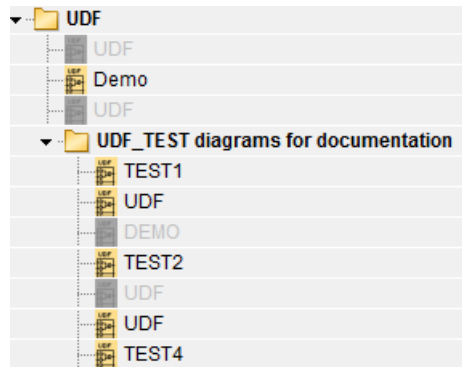

Note

A UDF created on LOGO! Base Module 0BA8 is invalid for LOGO! Base Module 0BA7.

Note

Not all UDFs can be used in a circuit program. Invalid UDFs appear in the block tree, but are gray. A UDF is invalid if it meets one or more of these conditions:

- The UDF has no blocks or connectors
 - The UDF has input or output connectors, but no block connections
 - The UDF contains blocks, but no in or out connectors
-

A circuit program can have at most 16 different UDFs, and no more than 64 UDF instances in total.

Within a circuit program, interaction with UDFs is consistent to other function blocks. Double-clicking, for example, produces the following dialog. With this dialog, you can set user-defined names and comments as other function blocks.

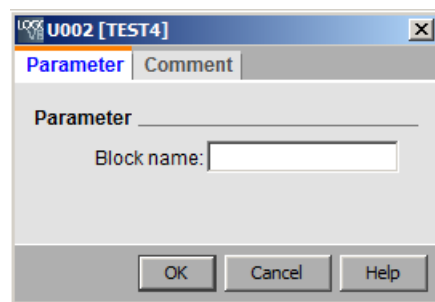

Similarly, other blocks can reference UDF parameters, for example, you can drag the input connector of the parameter box of a function block to the output connector of the parameter box of a UDF block:

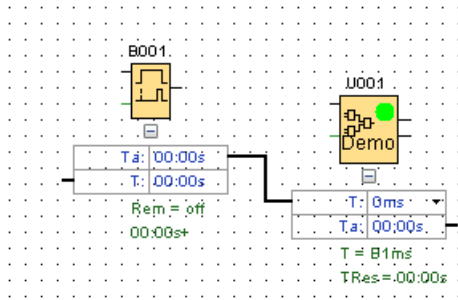

You can include editable UDF parameters in message texts (Page 310):

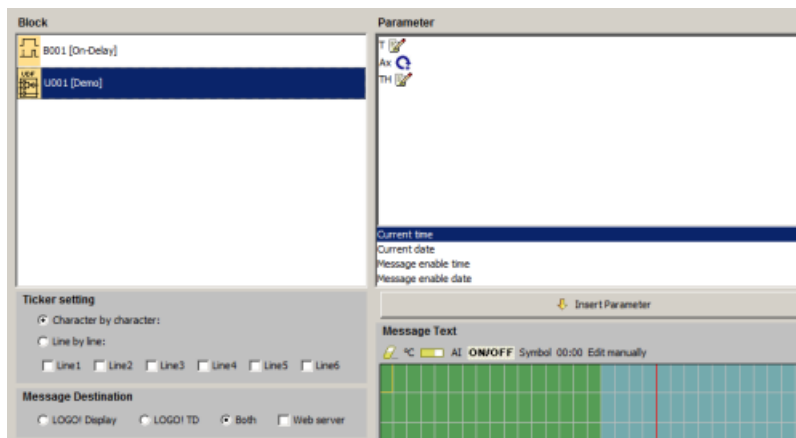

Note

You can not invert the input connectors of a UDF.

If a UDF internally references a parameter that is provided by another already-programmed function block, this parameter appears as "U*" when you use the UDF in a circuit program, for example:

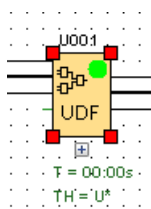

5.5.6 Synchronizing UDF versions

You can use a UDF in multiple circuit programs. If you update a UDF to a new version, synchronize the UDF instances, including any nested UDF instances, to the new version. Depending on how you use the UDF, LOGO!Soft Comfort indicates various conditions pertaining to the UDF update.

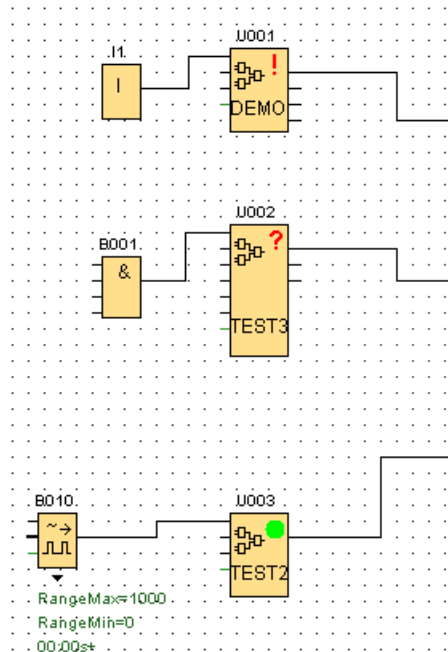

LOGO!Soft Comfort displays a warning signal (!) in the upper right corner to indicate that the UDF is out of date. You can right-click the block, and select "①" from the following context menu to update the UDF to a new version.

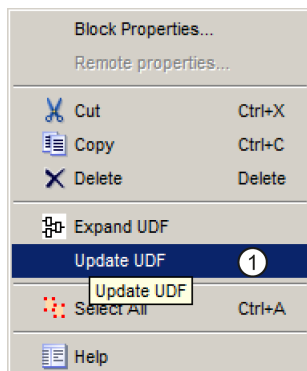

LOGO!Soft Comfort displays a question mark (?) if the UDF is not available in the current library. You have to re-import the UDF to the current UDF library to remove this problem.

A green mark (●) means the UDF is configured and of the latest version.

You can also update multiple UDFs at once. Select a group of UDFs, right-click, and select "①" from the context menu below. If there are conflicts, LOGO!Soft Comfort only updates the UDFs that can be updated without conflict. LOGO!Soft Comfort leaves those with conflicts as is, and produces a failure report in the "Info Window".

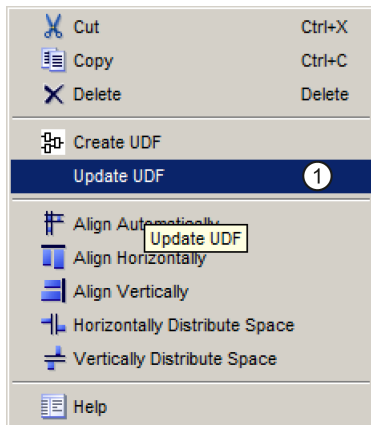

5.6 Circuit programs

With LOGO!Soft Comfort you can start right away to design your own circuit programs. The tutorial (Page 127) section provides you with detailed information about the creation and simulation of circuit programs.

You first use the LOGO!Soft Comfort software to write your programs, and secondly let LOGO!Soft Comfort calculate (Page 90) the minimum LOGO! version that you need to put your ideas into practice!

No particular program settings are required.

The type of LOGO! device you can use to put your ideas into practice depends on a number of factors:

- The number of I/O to be used
- Memory requirements (Page 360) of the circuit program
- The use of particular SFBs

5.6.1 LOGO! hardware

LOGO! hardware series

LOGO!Soft Comfort lets you create programs for LOGO! devices of various series. LOGO! device series vary in performance, memory space, number of program blocks (for example, flag blocks) and in the structure of the devices.



Because there are device-specific differences with regard to the functions, you must not only distinguish between the LOGO! versions, but also take their version status into account. You can identify the version status by the suffix of the LOGO! order number.

The current LOGO! versions belong to the 9th generation. They can be identified by the last digits of their order number: 0BA8.

You can identify the first three generations of LOGO! devices by the 0, 1 and 2 suffix. The major difference in the first three generations of LOGO! lies in their modular structure. Long and AS-Interface versions are no longer available as of version 0BA3. The standard devices are now equipped with an expansion interface, to which you can connect expansion modules (digital/analog and bus modules) for adapting the LOGO! to suit your personal requirements. This modular structure, however, has little to no influence on programming. You can still program your LOGO! in the usual way. All you have to take into consideration is that AS-Interfaces and analog I/O are determined by the position at which the relevant expansion module is installed.

Current devices

Name	Order number
LOGO! 12/24RCE *	6ED1052-1MD00-0BA8
LOGO! 24CE *	6ED1052-1CC01-0BA8
LOGO! 24RCE (AC/DC)	6ED1052-1HB00-0BA8
LOGO! 230RCE (AC/DC)	6ED1052-1FB00-0BA8
LOGO! 12/24RCEo *	6ED1052-2MD00-0BA8
LOGO! 24CEo *	6ED1052-2CC01-0BA8
LOGO! 24RCEo (AC/DC)	6ED1052-2HB00-0BA8
LOGO! 230RCEo (AC/DC)	6ED1052-2FB00-0BA8

* With analog inputs

Memory space is identical for all these devices.

The following expansion modules are available for the standard devices:

Name	Order no.
LOGO! DM8 230R	6ED1 055-1FB00-0BA2
LOGO! DM16 230R	6ED1 055-1FB10-0BA2

Name	Order no.
LOGO! DM8 24	6ED1 055-1CB00-0BA2
LOGO! DM16 24	6ED1 055-1CB10-0BA2
LOGO! DM8 12/24R	6ED1 055-1MB00-0BA2
LOGO! DM8 24R	6ED1 055-1HB00-0BA2
LOGO! DM16 24R	6ED1 055-1NB10-0BA2
LOGO! AM2	6ED1 055-1MA00-0BA2
LOGO! AM2 AQ	6ED1 055-1MM00-0BA2
LOGO! AM2 RTD	6ED1 055-1MD00-0BA2
LOGO! TDE	6ED1 055-4MH00-0BA1

You can use the description to identify the different properties of LOGO!:

- **12** means 12 V Version
- **24** means 24 V Version
- **230** means 115/230 V Version
- **R** means relay outputs (without R transistor outputs)
- **C** means integrated time/timer switch
- **o** means without display
- **E** means the LOGO! ... E version (with Ethernet interface)
- **DM** means digital module
- **AM** means analog module
- **TDE** means text display with Ethernet interfaces

Special functions, depending on LOGO! versions

Special function	OBA0 Standard	OBA0 ...L	OBA0 ...LB1 1	OBA1 all	OBA2 all	OBA3 all	OBA4 all	OBA5 all	OBA6 all	OBA7 all	OBA8 all
On delay	X	X	X	X	X	X	Xr	Xr	Xr	Xr	Xr
Off delay	X	X	X	X	X	X	Xr	Xr	Xr	Xr	Xr
Retentive on delay	X	X	X	X	X	X	Xr	Xr	Xr	Xr	Xr
On/off delay	-	-	-	-	X	X	Xr	Xr	Xr	Xr	Xr
Latching relay	X	Xr	Xr	Xr	Xr	Xr	Xr	Xr	Xr	Xr	Xr
Pulse relay	X	Xr	Xr	Xr	Xr	Xr	Xr	Xr	Xr	Xr	Xr
Wiping relay	-	X	X	X	X	X	Xr	Xr	Xr	Xr	Xr
Edge-triggered wiping relay	-	-	-	-	X	X	Xr	Xr	Xr	Xr	Xr
Weekly timer)*	X	X	X	X	X	X	X	X	X	X	X
Yearly timer)*	-	-	-	X	X	X	X	X	X	X	X
Up/Down counter	X	Xr	Xr	Xr	Xr	Xr	Xr	Xr	Xr	Xr	Xr
Hours counter	-	Xr	Xr	Xr	Xr	Xr	Xr	Xr	Xr	Xr	Xr

Special function	OBA0 Standard	OBA0 ...L	OBA0 ...LB1 1	OBA1 all	OBA2 all	OBA3 all	OBA4 all	OBA5 all	OBA6 all	OBA7 all	OBA8 all
Symmetrical pulse generator	X	X	X	X	X	X	X	X	X	X	X
Asynchronous pulse generator	-	-	-	X	X	X	Xr	Xr	Xr	Xr	Xr
Random generator	-	-	-	-	X	X	X	X	X	X	X
Threshold trigger	-	X	X	X	X	X	X	X	X	X	X
Analog threshold trigger	-	-	-	-	X	X	X	X	X	X	X
Analog comparator	-	-	-	-	X	X	X	X	X	X	X
Stairway lighting switch	-	-	-	-	X	X	Xr	Xr	Xr	Xr	Xr
Multiple function switch	-	-	-	-	X	X	Xr	Xr	Xr	Xr	Xr
Message text	-	-	-	-	X	X	X	X	X	X	X
Softkey	-	-	-	-	-	Xr	Xr	Xr	Xr	Xr	Xr
Shift register	-	-	-	-	-	-	Xr	Xr	Xr	Xr	Xr
Analog watchdog	-	-	-	-	-	-	Xr	Xr	Xr	Xr	Xr
Analog Amplifier	-	-	-	-	-	-	X	X	X	X	X
Analog Differential trigger	-	-	-	-	-	-	X	X	X	X	X
Analog multiplexer	-	-	-	-	-	-	-	X	X	X	X
PI Controller	-	-	-	-	-	-	-	Xr	Xr	Xr	Xr
Analog Ramp	-	-	-	-	-	-	-	-	X	X	X
Pulse width moderator (PWM)	-	-	-	-	-	-	-	-	X	X	X
Mathmatic instruction	-	-	-	-	-	-	-	-	X	X	X
Mathmatic instruction error detection	-	-	-	-	-	-	-	-	X	X	X
Astronomical clock	-	-	-	-	-	-	-	-	-	X	X
Stopwatch	-	-	-	-	-	-	-	-	-	Xr	Xr
Analog filter	-	-	-	-	-	-	-	-	-	X	X
Max/Min	-	-	-	-	-	-	-	-	-	Xr	Xr
Average value	-	-	-	-	-	-	-	-	-	Xr	Xr

X = Yes; - = No

)* = Use of this function only makes sense for LOGO! versions with integrated real-time clock.

r= retentive

5.6.2 Memory

5.6.2.1 Memory requirements

The blocks in your circuit program require a certain amount of memory space. The table shows you how much of the memory space each block occupies.

The "Rem" column (retentivity enabled) specifies the memory space required for data backup after power failure.

For LOGO! 0BA7 and LOGO! 0BA8 devices

Block	RAM (Bytes)	Rem (Bytes)
AND (Edge)	12	-
NAND	12	-
OR (Edge)	12	-
NOR	12	-
XOR	8	-
NOT	8	-
On delay	12	3
Off delay	16	3
On/off delay	16	3
Retentive on delay	16	3
Wiping relay	12	3
Edge-triggered wiping relay	20	4
Asynchronous pulse generator	16	3
Random generator	16	-
Stairway lighting switch	16	3
Multiple function switch	20	3
Weekly timer	24	-
Yearly timer	12	-
Astronomical clock	40	-
Stopwatch	28	19
Up/Down counter	32	5
Hours counter	36	13
Threshold trigger	20	-
Analog threshold trigger	20	-
Analog differential trigger	20	-
Analog comparator	24	-
Analog watchdog	24	-
Analog amplifier	12	-
Pulse width modulator (PWM)	32	-
Mathematic instruction	24	-

Block	RAM (Bytes)	Rem (Bytes)
Mathematic instruction error detection	16	1
Latching relay	12	1
Pulse relay	12	1
Message text	12	-
Softkey	12	2
Analog multiplexer	20	-
PI Controller	44	2
Analog filter	20	-
Max/Min	20	7
Average value	32	20
Analog ramp	40	-
Shift register	16	1

For LOGO! 0BA6 devices

Block	RAM (Bytes)	Rem (Bytes)
AND (Edge)	12	-
NAND	12	-
OR (Edge)	12	-
NOR	12	-
XOR	8	-
NOT	4	-
On delay	8	3
Off delay	12	3
On/off delay	12	3
Retentive on delay	12	3
Wiping relay	8	3
Edge-triggered wiping relay	16	4
Asynchronous pulse generator	12	3
Random generator	12	-
Stairway lighting switch	12	3
Multiple function switch	16	3
Weekly timer	20	-
Yearly timer	12	-
Up/Down counter	28	5
Hours counter	28	9
Threshold trigger	16	-
Analog threshold trigger	16	-
Analog differential trigger	16	-
Analog comparator	24	-

Block	RAM (Bytes)	Rem (Bytes)
Analog watchdog	20	-
Analog amplifier	12	-
Pulse width modulator (PWM)	24	-
Mathematic instruction	20	-
Mathematic instruction error detection	12	1
Latching relay	8	1
Pulse relay	12	1
Message text	8	-
Softkey	8	2
Analog multiplexer	20	-
PI Controller	40	2
Analog ramp	36	-
Shift register	12	1

For LOGO! 0BA5 devices

Block	RAM (Bytes)	Rem (Bytes)
AND (with/without edge evaluation)	12	-
NAND	12	-
OR (with/without edge evaluation)	12	-
NOR	12	-
XOR	8	-
NOT	4	-
On delay	8	3
Off delay	12	3
On/off delay	12	3
Retentive on delay	12	3
Wiping relay	8	3
Edge-triggered wiping relay	16	4
Asynchronous pulse generator	12	3
Random generator	12	-
Stairway lighting switch	12	3
Multiple function switch	16	3
Weekly timer	20	-
Yearly timer	8	-
Up/Down counter	24	5
Hours counter	24	9
Threshold trigger	16	-
Analog threshold trigger	16	-
Analog differential trigger	16	-

Block	RAM (Bytes)	Rem (Bytes)
Analog comparator	24	-
Analog value monitoring	20	-
Analog amplifier	12	-
Latching relay	8	1
Pulse relay	12	1
Message text	8	-
Softkey	8	2
Analog multiplexer	20	-
Controller	40	2
Analog ramp	36	-
Shift register	12	1

For LOGO! 0BA4 devices

Block	RAM (Bytes)	Rem (Bytes)
AND (with/without edge evaluation)	12	-
NAND	12	-
OR (with/without edge evaluation)	12	-
NOR	12	-
XOR	8	-
NOT	4	-
On delay	8	3
Off delay	12	3
On/off delay	12	3
Retentive on delay	12	3
Wiping relay	8	3
Edge-triggered wiping relay	16	4
Asynchronous pulse generator	12	3
Random generator	12	-
Stairway lighting switch	12	3
Multiple function switch	16	3
Weekly timer	20	-
Yearly timer	8	-
Up/Down counter	24	5
Hours counter	24	9
Threshold trigger	16	-
Analog threshold trigger	16	-
Analog differential trigger	16	-
Analog comparator	24	-
Analog value monitoring	20	-

Block	RAM (Bytes)	Rem (Bytes)
Analog amplifier	12	-
Latching relay	8	1
Pulse relay	12	1
Message text	8	-
Softkey	8	2
Shift register	12	1



OBA0-OBA3: The following specifications apply:

The blocks in your circuit program require a certain amount of memory space. The table below shows you how much memory space the blocks use in the various memory areas:

Block	Par	RAM	Timer	REM
Basic functions	0	0	0	0
On delay	1	1	1	0
Off delay	2	1	1	0
On/off delay	2	1	1	0
Retentive on delay	2	1	1	0
Wiping relay	1	1	1	0
Edge-triggered wiping relay	1	1	1	0
Symmetrical pulse generator	1	1	1	0
Asynchronous pulse generator	3	1	1	0
Random generator	2	1	1	0
Stairway lighting switch	1	1	1	0
Multiple switch	2	1	1	0
Weekly timer	6	2	0	0
Yearly timer	2	0	0	0
Up/Down counter*	2	(2)	0	(2)
Hours counter	2	0	0	4
Threshold trigger	3	3	1	0
Analog threshold trigger	4	2	0	0
Analog comparator	3	4	0	0
Latching relay*	0	(1)	0	(1)
Pulse relay*	0	(1)	0	(1)
Message texts	1	0	0	0
Softkey*	1	(1)	0	(1)

*: Depending on whether the function is configured with or without retentivity, it occupies the following memory space:

- Retentivity off: The function occupies RAM space
- Retentivity on: The function occupies REM space

Here you will find information on memory space provide by LOGO!. (Page 365)

5.6.2.2 Memory space

For LOGO! 0BA7 and LOGO! 0BA8 devices, you can use up to 400 blocks in your circuit program.

The maximum memory space a LOGO! circuit program can use is as follows:

- RAM: 8000 bytes (if 0BA7) or 8500 bytes (if 0BA8)
- Retentive data (REM): 250 bytes

For LOGO! 0BA6 devices, you can use up to 200 blocks in your circuit program.

The maximum memory space a LOGO! circuit program can use is as follows:

- RAM: 3800 bytes
- Retentive data (REM): 250 bytes

The Info Window displays the memory space used when you select the Tools → Determine LOGO! (Page 90) menu command, or when you press the function key (Page 31) [F2].

 0BA0 ⋮ 0BA7	The following specifications apply						
	LOGO! series	Blocks	Par	RAM	Timer	REM	Flags
	LOGO! 0BA4 to 0BA5	130	Not restricted	Not restricted	Not restricted	60	24
	LOGO! 0BA2 to 0BA3	56	48	27	16	15	8
	LOGO! 0BA1	56	48	27	16	15	4
	LOGO! 0BA0	30	27	24	10	0/7	0

A circuit program consists of a number of blocks, which start with an input and end with an output.

Nesting depth (LOGO! series 0BA0, 0BA1)

The number of blocks in a circuit program describes the nesting depth.

I/O in the sense of nesting depth are:

- Inputs (I (Page 193) , AI (Page 196))
- High, Low (Hi, Lo (Page 194))
- Memory markers (M (Page 195))
- Outputs (Q (Page 194))

Blocks in the sense of nesting depth are:

5.6 Circuit programs

- Basic functions (Page 207)
- Special functions (Page 212)

Further inputs/outputs according to the nesting depth are:

- Inputs AS-Interface (Ia (Page 25))
- Outputs AS-Interface (Qa (Page 25))

LOGO! restricts the nesting depth for your circuit program. Your circuit program has a maximum nesting depth of 58 objects.

This determines the following:

1 input + 56 blocks +1 output

Max. depth of a circuit program = 58 objects

During a simulation or download, the system returns an error message if you enter a program in LOGO!Soft Comfort that exceeds the maximum nesting depth.

Implementing large circuit programs

You can implement large circuit programs by means of signal recursion. You implement signal recursion by appending a flag block (Page 195) to the end of the program and connecting the remaining blocks to the output of the flag block. LOGO! interprets the flag as the output of the first program and also as the terminal block of the downstream blocks. LOGO! interprets the large program with flag as two separate programs. If no more flags are available, you can use an output block instead.

5.6.3 Blocks and block numbers

5.6.3.1 Blocks

Blocks represent terminals or functions. LOGO!Soft Comfort distinguishes between various types of block and identifies them by means of an abbreviation:

Block type	Identifier
Input	I
Output	Q
Shift register bit	S
Status 1 (high)	Hi
Status 0 (low)	Lo
Open connector	X
Cursor key	C
Function	B
LOGO! TD function key	F
Flag	M
Analog input	AI
Analog output	AQ

Block type	Identifier
Analog flag	AM
Network input	NI
Network analog input	NAI
Network output	NQ
Network analog output	NAQ
Data Log Profile	L
UDF	UDF

5.6.3.2 Block numbers

Block number assignment

LOGO!Soft Comfort assigns every block you insert in the circuit program a **block number**. LOGO! displays the number of the current block at the top of the display. LOGO!Soft Comfort displays the block number directly above the inserted block.

The LOGO! onboard display uses block numbers for orientation and for the assignment of logical links. In LOGO!Soft Comfort you can also track cut connections by means of their indicated block number.

Constants and terminals (Page 191) use the terminal name or a simple block name for identification rather than a block number. You can assign additional block identifiers to inputs (Page 193), output (Page 194), and flags (Page 195) with comments. The high and low (Page 194) signal blocks do not have a block number.

Determination of block numbers on a LOGO!

LOGO! has no default position for analog inputs or digital outputs. The hardware structure determines the block number.



On a LOGO! without modular structure, the position of an analog or digital output is fixed.

5.7 Network projects

Introduction

With LOGO!Soft Comfort V8.0, you can design your own network project in the project mode.

A network project typically consists of the following elements:

- Devices selected from the project tree
- Circuit diagrams for the devices
- Settings of the devices
- Network configuration of the devices

The tutorial (Page 149) section provides you with detailed information about the creation, device setting and Ethernet configuration of network projects.



The LAD and UDF Editors are not available in the project mode.

Tips and tricks

6.1 Tips and tricks

How to maintain an overview during simulation (Page 369)

A quick and easy way of selecting blocks and placing these into your circuit program (Page 369)

A quick and easy way of connecting blocks in large circuit programs (Page 370)

How to display a corresponding tooltip for a function key (Page 371)

How to identify your circuit program version (Page 371)

How to access functions via the shortcut menu (Page 371)

A quick and easy way of zooming your circuit program window (Page 371)

A quick way of changing block parameters (Page 371)

A quick way of closing circuit diagrams without saving the data (Page 372)

How to establish the cycle time (Page 372)

6.2 How to maintain an overview during simulation

To maintain a clear overview of large circuit programs when working with small or low-resolution monitors, follow these steps:

1. Maximize the LOGO!Soft Comfort application window to full screen size.
2. Close the Info Window and minimize the diagram tree and instruction tree.

Advantage: You have increased the space for editing the circuit program. You can access the I/O toolbars without restriction, since they always remain in the foreground.

Note: You can restore the diagram tree and instruction tree to their original position by left-clicking the  icon.

6.3 A quick and easy way of selecting blocks and placing these into your circuit program

You have two alternatives to the standard selection of blocks from the programming toolbar icons:

Alternative 1

1. Expand the catalog from the instruction tree.
2. Click the required block in the catalog to select it.
3. In your circuit program, left-click the block insert position. The block appears at the correct position.
4. To insert more than one instance of a block at a time, double-click the block, which causes LOGO!Soft Comfort to display a stamp icon beside the block. Left-click the locations on the programming interface for placing the multiple block instances.

Advantage: When you change between constants/terminals, basic functions and SFBs, you save yourself having to click the relevant icons in the programming toolbar.

Alternative 2

1. Open the catalog of the programming toolbar.
2. Click any block in the catalog to select it.
3. If you are creating a large program, you can close the catalog and also hide the programming toolbar.
4. Hold down the Ctrl key and left-click the block insert position in your circuit program. LOGO!Soft Comfort displays a mask with block list, from which you can select the required block with a double-click.

Tip: The mask header also contains an input field. You could, for example, enter the initial letter of the required SFB to restrict the display in the mask to a list of blocks with this initial. You thus do not have to browse the entire mask, and you can quickly find the relevant block.

LOGO!Soft Comfort inserts the block at the correct position in your circuit program.

5. To insert further instances of this block, left-click the relevant insert positions.

Advantage: You do not have to depend on the catalog to create large programs. You can thus close and hide it to provide more screen space for your circuit program.

6.4 A quick and easy way of connecting blocks in large circuit programs

In addition to the conventional method of creating connections with the programming toolbar icons, you have another alternative:

1. After you have placed the blocks into the circuit program, double-click the input or output of a block.
2. A mask opens with a list of the target blocks. Double-click to select a block.
Tip: The mask header also contains an input field. You could, for example, enter the initial letter of the required SFB to restrict the display in the mask to a list of blocks with this initial. You thus do not have to browse the entire mask, and you can quickly find the relevant block.

In addition, you can also use wildcards such as * or ?.

LOGO!Soft Comfort makes the connection between the two blocks.

Advantage: Particularly when you are handling large circuit programs, this method provides you with a quick and easy means of creating connections.

6.5 How to display a corresponding tooltip for a function key

Prerequisite: The tooltips (Page 68) are enabled.

You can hover over an icon to see a tooltip for the icon, as well as the function key (Page 31) (if available) that performs the corresponding function.

6.6 How to identify your circuit program version

You can specify the version number of your current circuit program in the **Version** field in the File → Properties: Additional Info (Page 57) dialog. LOGO!Soft Comfort maintains the version information when you download and upload the circuit program between the PC and LOGO!.



This special function is only available with devices as of hardware series 0BA2.

6.7 How to access functions via the shortcut menu

Right-click an object to open a shortcut menu that offers you all the major functions for that object.

6.8 A quick and easy way of zooming your circuit program window

Press [CTRL] and turn the mouse wheel.

Result: The size of your circuit program window changes.

6.9 A quick way of changing block parameters

Click the parameter field you want to change, and turn the mouse wheel.

Result: The parameter changes.

6.10 A quick way of closing circuit diagrams without saving the data

You quickly close one or more circuit programs with saving the data:

- Open the **File** menu, press [CTRL] and click the **Close** menu command.
Result: The currently active circuit program is closed without prompt.
- Open the **File** menu, press [CTRL] and click the **Close All** menu command.
Result: All open circuit programs are closed without prompt.

Caution: New or changed circuit programs will not be saved.

6.11 How to establish the cycle time

The cycle time is the program processing time (reading inputs, executing programs and writing outputs).

The cycle time of each function is less than 0.1 ms. You can establish the cycle time of the circuit program by using a test program. Refer to the *LOGO! Manual*, Appendix B for more information.



The execution time of individual functions in LOGO! hardware series 0BA3 or older is indeterminate, and the times vary for each function. You can only establish the time for one program cycle. Refer to the *LOGO! Manual*, Appendix B for more information. You can download this from the LOGO! homepage on the Internet.

Index

A

- Access control, 83
- Acknowledgment of message texts, 327
- Additional functions of the LAD Editor, 338
- Air-conditioning system, 181
- Align selected objects horizontally, 60
- Align selected objects vertically, 60
- Alternative operation, 147
- Analog Amplifier, 268
- Analog basics, 286
- Analog comparator, 262
- Analog contact, 205
- Analog differential trigger, 260
- Analog filter, 279
- Analog input filter timer, 52
- Analog inputs, 196
- Analog multiplexer, 269
- Analog outputs, 197
 - AQ in STOP mode, 55
- Analog Ramp, 304
- Analog SFBs, 268
- Analog threshold trigger, 255
- Analog value, 286
- Analog watchdog, 265
- Applications, 181
- Archiving, 49, 50
- Arrange
 - horizontal, 60
 - vertical, 60
- AS-Interface, 23
- AS-Interface inputs, 25
- AS-Interface outputs, 25
- Astronomical Clock, 243
- Asynchronous pulse generator, 228
- Automatic alignment, 61
- Availability of blocks, 132
- Average value, 285

B

- Backup of the real-time clock, 239
- Basic functions, 207
 - AND, 208
 - AND with edge evaluation, 208
 - NAND, 209

- NAND with edge evaluation, 209
- NOR, 211
- NOT, 212
- OR, 210
- XOR, 211
- Block, 128, 130
 - connecting, 130
 - memory requirements, 360
 - selecting, 128
- Block comment, 139
- Block diagram, 171
- Block numbering, 128, 129
- Block numbers, 367
- Block parameters in message texts, 327
- Block properties, 64
- Blocks, 366
- Break contact, 205
- Bring to front, 63

C

- Catalog, 33
- Character sets
 - message texts, 52
- Circuit program, 128, 139, 140
 - archiving, 140
 - creating, 128
 - Documentation, 139
 - loading, 140
 - new, 128
- Circuit project, 149
 - creating, 149
 - new, 149
- Cleaning up the programming interface, 175
- Clipboard, 47, 59, 60
- Clock, 80
- Color, 122
- Comments
 - associated, 139
 - block-independent, 139
- Compare circuit programs, 90
- Compatibility, 21
- Configure the data log, 339
- Configuring Ethernet connection
 - client/server connections, 166
 - LOGO! to HMI devices, 165
 - LOGO! to local LOGO!, 157
 - LOGO! to LOGO! slave, 163

- LOGO! to remote devices, 161
- LOGO! to S7 devices, 164
- Connecting blocks, 130
- Connector tool, 39
- Constants and connectors, 191
- Context-sensitive help, 125
- Control and regulate basics, 293, 296
- Controller
 - PI, 296
- Controller, PI, 299
- Converting, 40, 40
- Copy, 60
- Counter, 247
- Create a UDF, 341
- Cursor keys, 193
- Cut connections, 137
- Cut/Join, 39

D

- Data Log, 339
- Date, 80
- Defining the editor, 119
- Determine LOGO!, 90
- Digram mode, 32
- Documentation, 179
- Documentation of the circuit program, 139

E

- Edge-triggered wiping relay, 226
- Edit menu, 58
 - Block properties, 64, 121
 - Block properties dialog box, 64
 - Bring to front, 63
 - Clipboard content, 60
 - Clipboard:within the program, 60
 - Copy, 60
 - Copy selected object, 60
 - Cut, 59
 - Cut Connections, 121
 - Cut selected object, 59
 - Delete, 59
 - Input/Output Names, 63
 - Paste, 60
 - Redo, 59
 - Select all, 62
 - Send to back, 63
 - Undo, 59
- Editing the layout, 135
 - Editing selected objects, 136

- Selecting objects, 136
- Editing the UDF
 - add/remove connectors, 344
 - comment, 349
 - configure UDF properties, 345
 - I/O, 346
 - parameters, 348
 - UDF identifier, 350
 - UDF password, 346
- Entering Input/Output Names, 63
- Example, 291
- Exit, 58

F

- Factory door, 183
- FAQs, 21
- FBD, 20
- File
 - File name extension, 50
 - Path and file name, 50
- File menu, 46
 - Archiving, 50
 - Close, 48
 - Close all, 49
 - Exit, 58
 - New, 47
 - Page format, 51
 - Print, 51
 - Print preview, 51
 - Properties: General, 54
 - Properties: Page format, 40
 - Properties: Statistics, 57
 - Save, 49
 - Save As, 50
- Fill station, 187
- Fine positioning, 66
- Flags, 195
- Font, 65
- Format menu
 - Font, 65
 - Format grid, 66
 - Snap to grid, 66
- Frequency inputs, 95
- Function Block Diagram, 20
- Function keys, 31

G

- Gain, 286
- Go to connection, 137

Grid, 66

H

Hardcopy, 51
 Hardware, 90
 Heating control, 184
 Help menu, 124

- About, 126
- Contents, 124
- Context-sensitive help, 125
- Update Center, 125

 Hi (high), 194
 Hours counter, 249

I

Info window, 27, 30
 Information on analog value processing, 286
 Input functions, 95
 Input of project data, 172
 Input terminals, 25
 Input/Output Names, 63
 Inputs, 193
 Internet, 21
 Introduction, 127, 149
 Inverting, 206, 207, 212

L

Labeling, 139
 LAD, 20
 Ladder Diagram, 20
 Latching relay, 307
 Layout of inputs, 141
 Layout of message texts, 143
 Layout of the standard solution, 170
 Line crossings, 137
 Lo (low), 194
 LOGO!, 21

- compatibility, 21
- hardware series, 357
- unit series, 21

 LOGO! applications, 181
 LOGO! TD, 18
 LOGO! TD/TDE function keys, 193
 LOGO! version, 357

M

Make contact, 205
 Mathematic instruction, 276
 Mathematic instruction error detection, 337
 Max/Min, 280
 Measurement range, 286
 Memory space, 365

- maximum, 365
- required, 360

 Message online test, 315, 326
 Message Text Settings, 52
 Message texts, 143, 327
 Message window, 30
 Mode selection, 37
 Modem configuration, 97

- configuring local modem command, 99
- configuring remote modem command, 98
- configuring telephone number, 99
- disconnecting, 99
- selecting modem to configure, 98, 99

 Monthly timer, 239
 Multiple function switch, 234

N

Nesting depth, 365
 New, 18
 New SFBs, 18

O

Off delay, 218
 Offset, 286
 On delay, 217
 On/Off delay, 220
 Online Test, 41, 180
 Open, 47
 Open connectors, 195
 Optimizing the view, 177
 Order number, 357
 OT limit value, 249
 Output, 142, 194

P

Page break, 137
 Page format, 40
 Parameter, 212
 Parameter assignment in simulation mode, 146
 Password, 56

Paste, 60
Path and file name, 49, 50
PC settings, 155
Permanent logical levels, 194
PI controller, 300
PI controller trend view, 35
Placing blocks, 128, 129, 173
Positioning, 128, 129
Power failure, 143
Practical example, 168
Prerequisites for working with the tutorial, 127
Print, 120
Priority of message texts, 327
Project mode, 33
Properties, 54, 57
 General, 54, 57
 Hardware type, 55
Protection, 212
Pulse output timer, 239
Pulse relay, 308
Pulse Width Modulator PWM, 273

R

Random generator, 230
Redo, 59
Reference, 212
Regulate, 293
Relay coil output, 206
Replacing blocks, 137
Retentive on delay, 222
Retentivity, 212

S

Sample application, 168
Sample applications, 181
Save, 49
Save As, 50
Save the UDF, 352
Scale time type, 324
Screen, 120
Selection tool, 38
Service water pump, 168
Set Clock, 80
Set output, 142
Set Parameter, 212
Settings, 52
 LOGO!, 290
 LOGO!Soft Comfort, 289
 Message Texts, 52

SFBs, 286
 analog, 286
Shift register bits, 194
shift register function, 333
Shortcuts, 31
Signal recursion, 365
Simulation
 starting, 95, 141
 status display, 35
 time, 147
 toolbox, 35
Snap to grid, 66
Softkey, 332
Solution
 practical example, 171
Solution, practical example, 170
Special functions, 212
 dependency on versions, 357
 overview, 212
Stairway lighting switch, 232
Start LOGO!, 77
Statistics tab, 57
Status bar, 27, 31
 description, 31, 95
Status window, 95
Stop LOGO!, 77
stopwatch, 245
Symmetrical pulse generator, 227
Synchronize UDF versions, 355

T

Task, 168
TD power-on screen, 82
Testing the circuit program, 178
Text tool, 39
Threshold trigger, 253
Ticker timer, 52
Time control for simulation, 147
Tips and Tricks, 369
Toolbar, 27, 34
 simulation, 27
 standard, 27
 tool, 27
Tools → Options menu
 Color, 122
 Editor, 119
 Print, 120
 Screen, 120
Tools menu, 37, 70
 Connect Modem, 97
 Determine LOGO!, 90

- Disconnect Modem, 99
- Online Test, 41
- Select Hardware, 90
- Simulation, 95
- Simulation Parameters, 95
- Transfer menu
 - Set Clock, 80
 - Start LOGO!, 77
 - Stop LOGO!, 77
- Transfer the data log, 340
- Transferring the circuit program, 179
- Trend view, 35
- Type of texts, 120

U

- Undo, 59
- Update Center, 21
- User interface, 27

V

- View menu, 66
 - Optimizing, 175
 - Select Lines, 68
 - Status bar, 68
 - Tooltips, 68

W

- Weekly timer, 237
- Window menu, 122
 - Selection list, 123
 - Undo Split, 122
- Wiping relay, 224

Y

- Yearly timer, 239

Z

- Zero offset, 286
- Zooming, 69

